

ASSEMBLY INSTRUCTIONS



Fine Furniture for every stage of life

Side Table

ASSEMBLY INSTRUCTIONS

ASSEMBLY TIPS:

1. Remove hardware from box and sort by size.
2. Please check to see that all hardware and parts are present prior to start of assembly.
3. Please follow attached instruction in the same sequence as numbered to assure fast & easy assembly.



WARNING!





1. Don't attempt to repair or modify parts that are broken or defective. Please contact the store immediately.
2. This product is for home use only and not intended for commercial establishment.

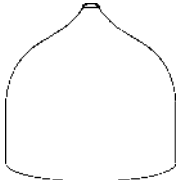

ASSEMBLY TIME

5 MINUTES

PARTS IDENTIFICATION

A	BASE		1PC
B	CAP		1PC
C	TOP		1PC
D	PEDESTAL COLUMN		1PC

:
ASSEMBLY INSTRUCTIONS

STEP 1

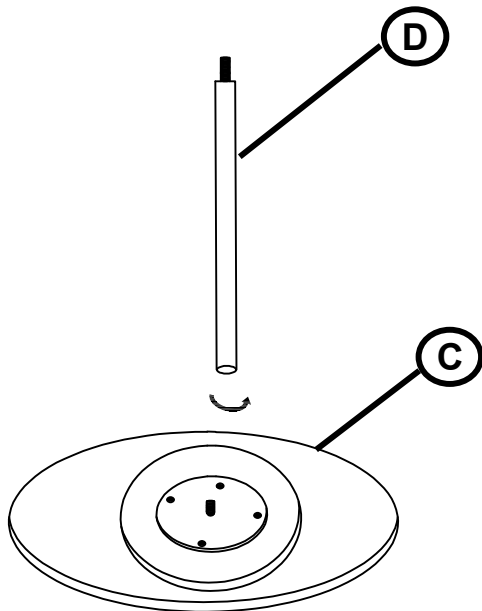

STEP 2

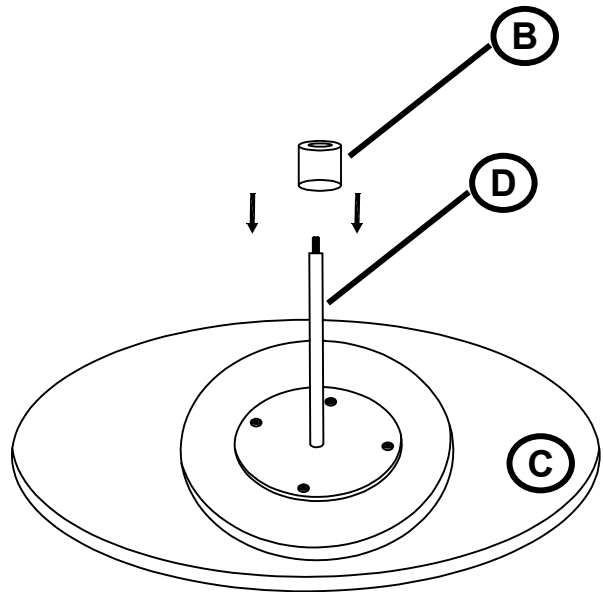

STEP 3

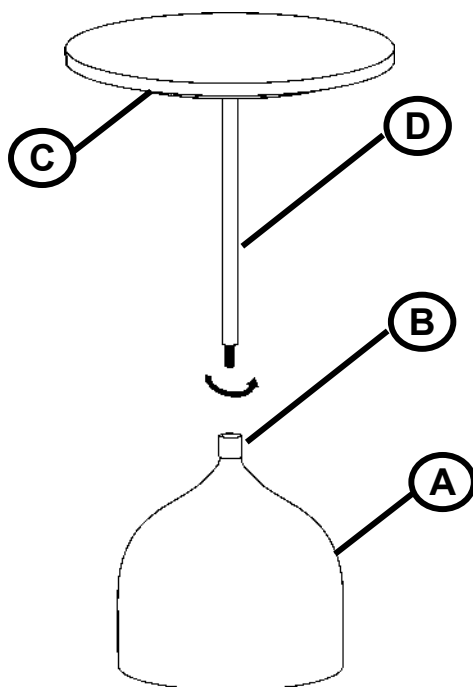

STEP 4
COMPLETE

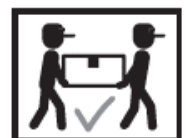
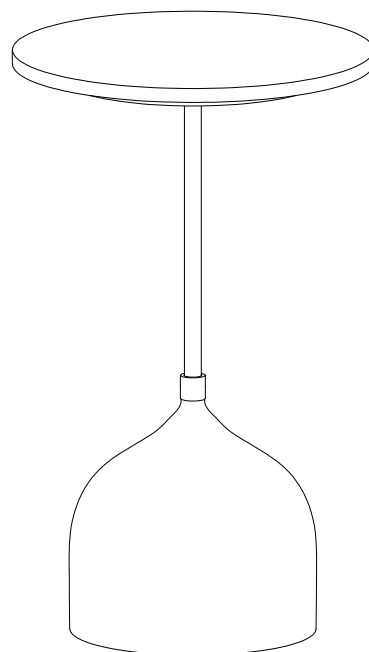

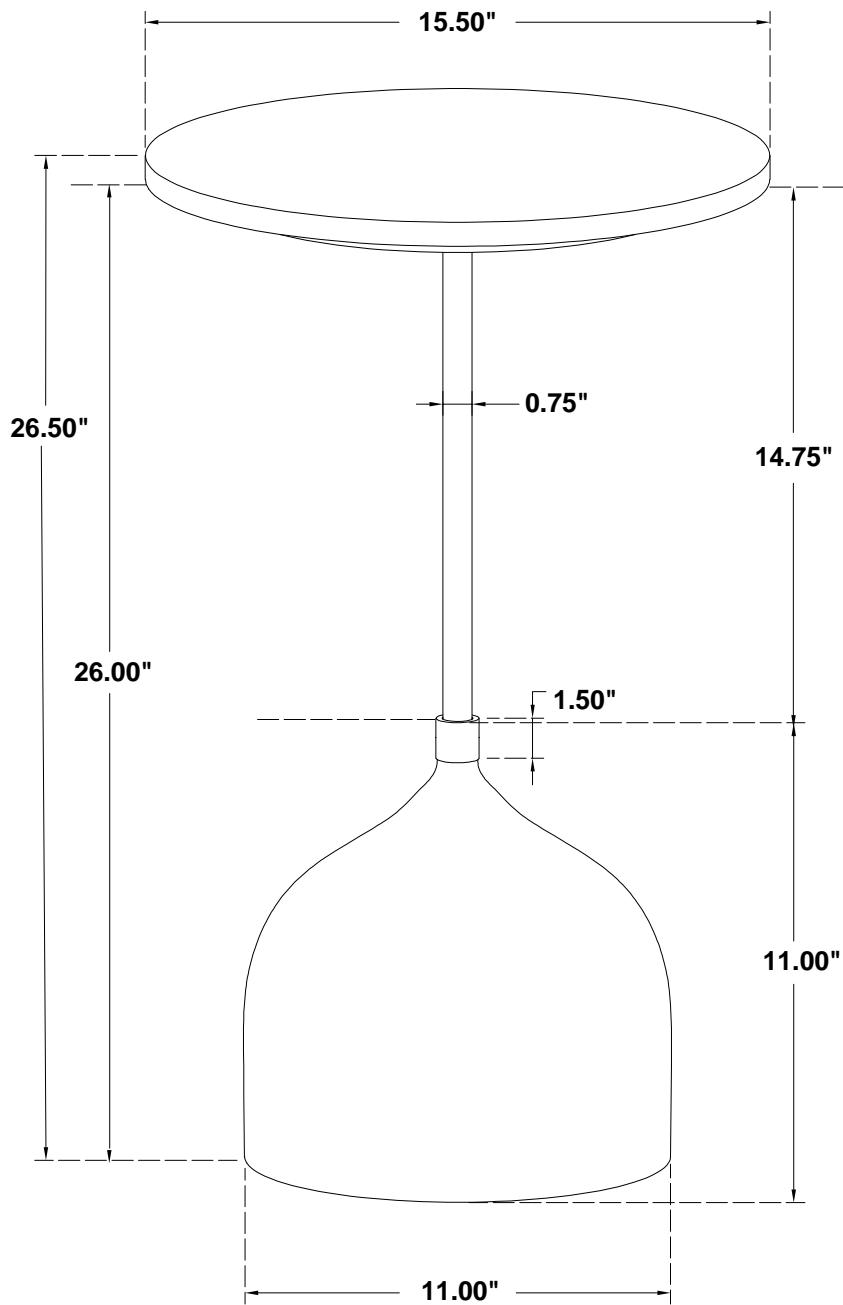

Note : Dimension tolerance $\pm 5\%$