

SAFETY PRECAUTION:

IMPORTANT: PLEASE READ BEFORE INSTALLATION:

1. Before you begin installing the fan, shut power off at the circuit breaker of the fuse box.
2. **CAUTION:** Read all instructions and safety information before installing your new fan. Review accompanying assembly diagrams.
3. Make sure that all electrical connections are in accordance with National Electrical Code, ANSI/NFPA 70 and local codes. Hire a licensed electrician if you are unfamiliar with installing electrical wiring.
4. Make sure the installation site you choose allows the fan blades to rotate without any obstructions. Allow a minimum clearance of 2.1m (7 feet) from the floor and 18 inches from the tip of the blades to the wall.
5. **WARNING:** To reduce the risk of fire, electric shock, or personal injury, mount to outlet box marked "Acceptable for Fan Support of 15.9 kg (35 lbs) or less" and use mounting screws provided with the outlet box.
6. **CAUTION:** To reduce the risk of injury, use only the screws provided with the outlet box in conjunction with the lock washers provided with the fan.
7. The outlet box and support structure must be securely mounted and capable of reliably supporting a minimum of 35 pounds. Use only U.L. listed outlet boxes marked "Acceptable for Fan Support of 15.9 kg (35 lbs) or less".
8. After you install the fan, make sure that all mounting components are secured to prevent the fan from falling.
9. Do not insert anything into the fan blades while the fan is operating.
10. To change the direction of the rotation of the blades the fan must be in operation mode.
11. All set screws must be checked and retightened where necessary before installation.
12. **WARNING:** To reduce the risk of personal injury, do not bend the blade bracket when installing the brackets, balancing the blades, or cleaning the fan. Do not insert foreign objects in between rotating fan blades.
13. **CAUTION:** To reduce the risk of electric shock, disconnect the electrical supply circuit to the fan before installing light kit.
14. After making the wire connections, the wires should be spread apart with the grounded conductor and the equipment-grounding conductor on one side of the outlet box and the ungrounded conductor on the other side of the outlet box.
15. The splices after being made should be turned upward and pushed carefully up into the outlet box. Conductor wiring identified as grounded is to be connected to a grounded conductor of power supply. Conductor wiring identified as ungrounded conductor is to be connected to an ungrounded conductor. Conductor wiring identified for equipment grounding is to be connected to an equipment-grounding conductor.
16. This device complies with part 15 of the FCC Rules. Operation is subject to the following two conditions: (1) This device may not cause harmful interference, and (2) this device must accept any interference received, including interference that may cause undesired operation.
WARNING: To reduce the risk of fire or electric shock, this fan must be installed with a general use, isolating wall control/switch.
WARNING: To reduce the risk of fire or electric shock, do not use this fan with any solid-state speed control device.
NOTE: The important safeguards and instructions appearing in this manual are not meant to cover all possible conditions and situations that may occur. It must be understood that common sense, caution and care are factors which cannot be built into this product. These factors must be supplied by the person (s) installing, caring for and operating the unit.
17. This product is suitable for use in damp locations.
CAUTION: The light source is designed for this specific application and can overheat if serviced by untrained personnel. If any servicing is required, the product should be returned to an authorized service facility for examination or repair.

BEFORE YOU START

Contact a licensed electrician if you are uncomfortable performing electrical work. A licensed electrician must install the fan if required by local code. Do not use the fan with a dimmer switch. Turn off power at breaker.

Product instruction:

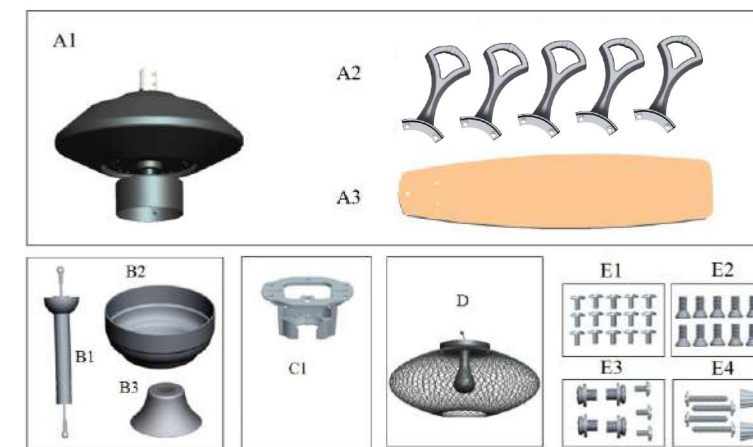

Tools and Materials Required

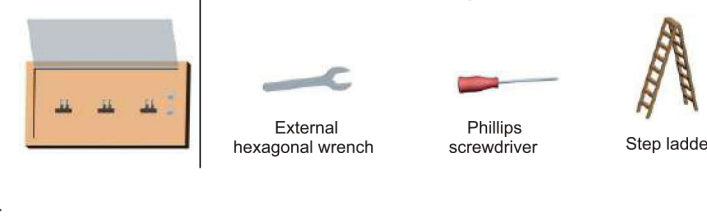

Installation:

1. Install Airfoils:

As shown in the Fig 1.1, take the Aluminum Alloy Airfoil Support A2, the Plywood Airfoils A3, and the M5X6 Screws E1 for installation and connection. Fig 1.2 shows the schematic diagram of the airfoil support and fan blade after installation.

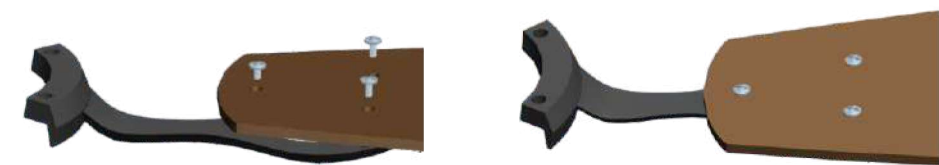

Fig 1.2

2. Install airfoil support:

As shown in Fig 2.1, install the installed airfoil support and fan blades on the Motor Hub A1, connect and fix with M6X12 Screws E2, and use a Phillips screwdriver to fasten the airfoil support to the Motor Hub, Fig 2.2 Schematic diagram after installing the airfoil support and fan blades.



Fig 2.2

3. Install the Downrod and Canopy:

Take out the fittings in the Fig 3.1 below, and put the Canopy and Wiring cover from the lower end of the Downrod assembly through the following Fig 3.2 The bell has been worn.



4. Install the Downrod and Canopy:

Pass the power cord of the motor hub through the Downrod as shown in the Fig 4.1, connect the notched end of the Downrod with the plastic hanger as shown in the Fig 4.2, and fix the safety rope on the motor shaft with screws. Using the M6X12 screws lock the lifting head, the Downrod, and the motor shaft. The Fig 4.3 shows that after the screw is locked, the Fig 4.4 covers the Downrod with the screws.

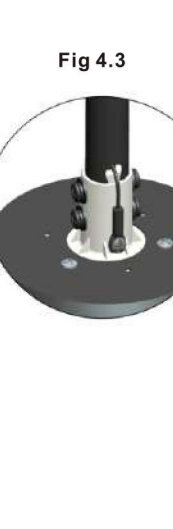
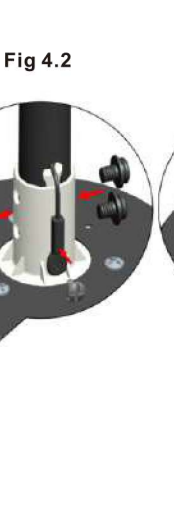

5. Assembly — Hanging the Fan:

Install the mounting bracket to the ceiling box, as shown in Fig 5.1 below. Rotate the mounting bracket in different directions so that the bracket mounting holes match the screw holes of the ceiling box. **Note:** This mounting bracket is a standard cable box. If the mounting bracket is installed at the outlet box, it should be installed on the outlet box with two screws matching the outlet box itself, as shown in Fig 5.1. This bracket can also be mounted to the wooden ceiling beam, and then the four ST5x24 screws can be used to lock the corresponding holes on the left and right sides of the bracket. **Note:** The wooden ceiling beam must meet the tensile test of 30KG for installation, as shown in Fig 5.2. It is also possible to install the mounting bracket directly to the concrete ceiling and install four screws to the left and right corresponding holes of the bracket to lock the ceiling, as shown in Fig 5.3.

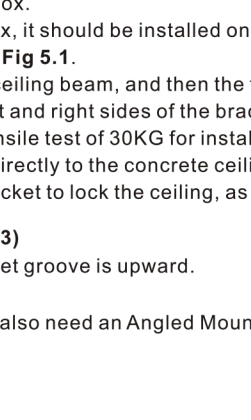
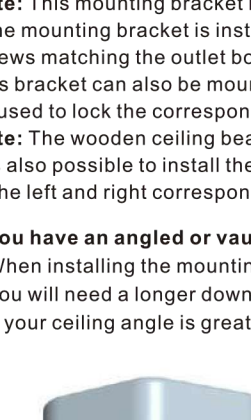

If you have an angled or vaulted ceiling: (Fig 5.3)

1. When installing the mounting bracket, the bracket groove is upward.
2. You will need a longer downrod.
3. If your ceiling angle is greater than 25°, you will also need an Angled Mounting Kit.



6. Wiring the ceiling fan:

6.1 Hang the installed ceiling fan on the hanger that has been fastened to the ceiling along the direction of the hanger notch. Rotate the hanger to make the notch on the drop ball coincide with the convex point on the hanger, as shown in Fig 6.1.
6.2 Fasten the safety rope in a safe place. The white wire of the power cord corresponds to the neutral wire of the room, and the black wire corresponds to the live wire. Connect the wiring caps one by one. The yellow and green wires are ground wires and need to be connected accordingly. As shown in Fig 6.2.

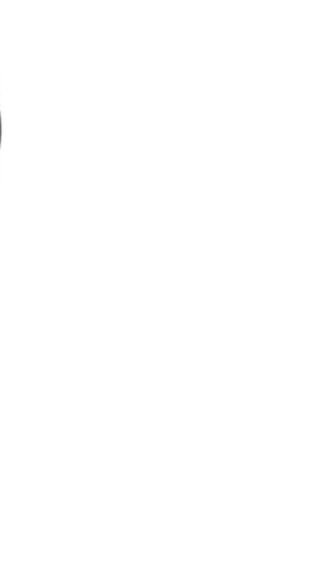
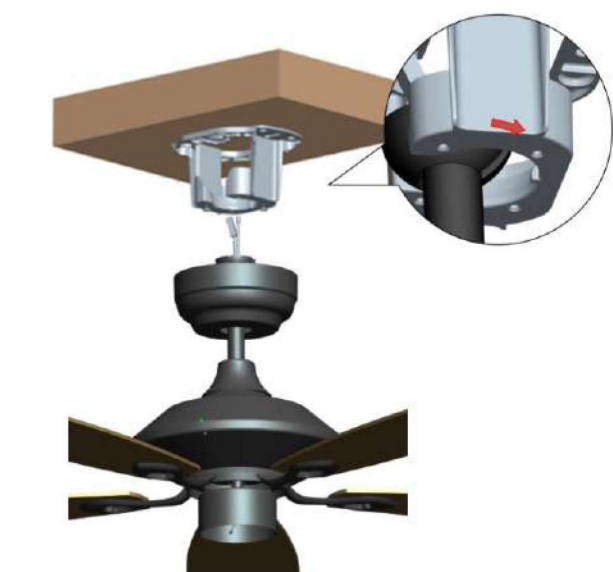

7. Fix and lock the Canopy:

Move the large and small screw holes at the bottom of the Canopy to the mounting bracket screws as shown in the diagram in Fig 7.1, pass the large holes on the left and right sides of the hanging cup through the screws and turn counterclockwise to the small holes according to the arrows in the diagram. As shown in the diagram below in Fig 7.2.



8. Connect the Chandelier components:

As shown in Fig 8.1, first connect the Lamp Wire terminals, and then use M4*6 screws to fix it. As shown in Fig 8.2, the Lampshade is installed.

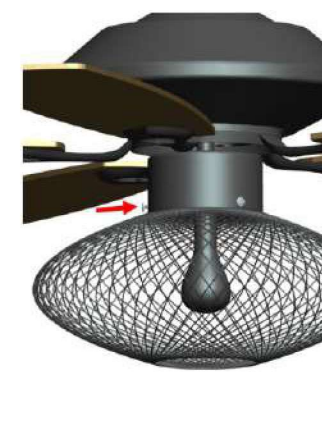
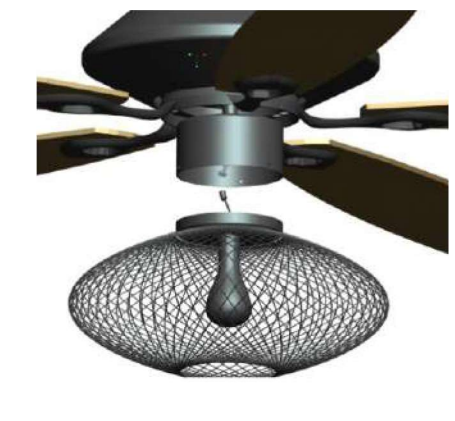

Power on:

The Fig 9.1 below is a schematic diagram of the whole machine installed. At this time, the ceiling fan has been installed. Turn on the main switch or the room where the ceiling fan is installed. After the ceiling fan is powered on, a beeping sound indicates that the ceiling fan is powered on.

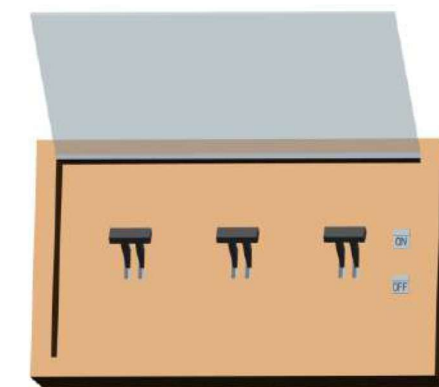







Fig 9.1

Remote Control Operating Instructions:







Pairing the Remote Control to Your Fan

Within 10 min. of plugging fan to power source, press and hold  button for 5 sec. to pair remote control and fan. Successful pairing will trigger a beep alert.

Remote Control button definitions

- (1)  OFF Turns the fan off.
- (2)  F/R Switches between summer mode and winter mode.
 - Summer mode - (Counter-clockwise) A downward airflow creates a cooling effect.
 - Winter mode - (Clockwise) An upward airflow moves warm air away from the ceiling area and redistributes it around the living space.
- (3)  Turns the fan on and decreases fan speed.
-  Turns the fan on and increases fan speed.



- (4) Operate the  button on the remote control, press this button, the buzzer will sound once, and the fan and lights will turn off.
- (5) Operate the  button on the remote control, press this button, the buzzer will sound once, and the fan will be turned off for 1 hour when it is turned on.
- (6) Operate the  button on the remote control, press this button, the buzzer will sound once, and the fan will be turned off for 2 hours when it is turned on.
- (7) Operate the  button on the remote control, press this button, the buzzer will sound once, and the fan will be turned off for 4 hours when it is turned on.
- (8) Operate the  button on the remote control, press this button, the buzzer will sound once, and the fan will be turned off for 8 hours when it is turned on.
- (9) The  button on the remote control, press this button, the buzzer will sound once, and the light will switch on or off.
- (10) The remote control has an indicator light, which will flash every time you press the button.
- (11) The corresponding relationship of the speed of each gear of the remote control is as follows:

Corresponding table of remote control gear:

Remote control gear	1	2	3	4	5	6	7	8	9	10
speed of the fan	50	64	78	92	106	119	133	150	165	180

Warning: Do not expose the remote control to direct contact of water.

Basic product parameters:

Model	ADC525D1L1	Voltage	120V
Fan Blade Span	52"	Rated Wattage	94W(Fan 34W Lamp 60W)
Gross weight	15.1lbs.	Rpm	66-200rpm
Maximum Airflow	4490CFM	Maximum Noise	55dB(A)

Model	ADC565D1L1	Voltage	120V
Fan Blade Span	56"	Rated Wattage	94W(Fan 34W Lamp 60W)
Gross weight	15.7lbs.	Rpm	66-185rpm
Maximum Airflow	5087CFM	Maximum Noise	55dB(A)

Care and cleaning:

- Check the support connections, brackets, and airfoil attachments twice a year. Make sure they are secure. Because of the fan's natural movement, some connections may become loose over time. It is not necessary to remove the fan from the ceiling.
- Clean your fan periodically. Use only a soft brush or lint-free cloth to avoid scratching the finish. The plating is sealed with a lacquer to minimize discoloration or tarnishing.
- (Optional) Apply a light coat of furniture polish to the wood blades.
- (Optional) Cover small scratches with a light application of shoe polish.

Do not:

- Use water when cleaning. Water could damage the motor, or the wood, or possibly cause an electrical shock.
- Apply oil to your fan or motor. The motor has permanently lubricated sealed ball bearings.

Note: Power off the fan before product maintenance or cleaning the fan.

FCC Statement:

NOTE: This equipment has been tested and found to comply with the limits for a Class B digital device, pursuant to part 15 of the FCC Rules. These limits are designed to provide reasonable protection against harmful interference in a residential installation. This equipment generates, uses and can radiate radio frequency energy and, if not installed and used in accordance with the instructions, may cause harmful interference to radio communications. However, there is no guarantee that interference will not occur in a particular installation. If this equipment does cause harmful interference to radio or television reception, which can be determined by turning the equipment off and on, the user is encouraged to try to correct the interference by one or more of the following measures:

- Reorient or relocate the receiving antenna.
- Increase the separation between the equipment and receiver.
- Connect the equipment into an outlet on a circuit different from that to which the receiver is connected.
- Consult the dealer or an experienced radio/TV technician for help.

WARNING: Changes or modifications to this unit not expressly approved by the party responsible for compliance could void the user's authority to operate the equipment.

Troubleshooting:

Try these troubleshooting steps before contacting the Customer Service. For additional operation, maintenance, and troubleshooting information, please contact our customer service center.

SYMPTOM	POSSIBLE SOLUTION
Fan not spinning	<ol style="list-style-type: none"> Make sure the fan is getting power. Check your circuit breaker or fuse panel and wall switch for functionality. Fan wires are connecting with the house wires correctly. Remote control must be paired with the fan within 10 minutes after the fan getting power If you have paired the app but the fan still didn't work (light and fan both didn't work) or couldn't pair the app to the fan, try to reset the fan: to reset the fan, cut the power for 10 minutes, then turn the power on and press the pairing button  on the remote for 5 seconds till hear beep sound, then pair the Carrohome app again. Use a multi-meter and test the adapter wiring harness to see if there is any electrical output. All the pin wiring on the circuit board are inserted tight and in the right position. Remote need to pair with the fan first. Make sure the fan blades spin freely. If you're using a wall control, check the power to the breaker from your control and try working your ceiling fan manually. (Normal switch only for the fan power on/off)
Fan light not working	<ol style="list-style-type: none"> Make sure LED wires are connected to the circuit board. Make sure the whole fan is powered. Remote need to pair with the fan first, correctly and in the retention slot.
The fan is noisy and wobbling	<ol style="list-style-type: none"> Check if the blade screws are NOT rubbing against the round plastic part of the motor. Check the pin wire are NOT connected against the moving part. Check the down fan cup is NOT hitting the motor. Confirm the canopy is NOT touching the ceiling while the fan is in operation. Check the down rod is NOT slanted. Tighten any loose screws on the light kit, fan blades, motor coupling, down rod, brackets and mounting hardware. Confirm the hanger ball is firmly seated in the mounting bracket. The ceiling beam must meet the minimum tensile test strength of 30KG for installation. Make sure the airfoils and brackets are NOT bent or deformed. Verify the wire connections are not rattling against each other. Verify the fan blades are not cracked. If the fan blades are cracked, replace the damaged blades with a new blade set from the same brand as your ceiling fan to ensure compatibility. The light kit is NOT slanting and hitting the motor.
Unable to pair remote and app	<ol style="list-style-type: none"> Check if the wires are connected in the right position or not. Check the batteries in the remote. Disconnect the power for 10 minutes, reconnect the power and pair the remote with the fan immediately, within 5 seconds. Also try pairing the App to reconnect. The WiFi must be 2.4Ghz, incompatible with 5Ghz WiFi or combine with 5Ghz. App must in the new version. Connect with correct app "Carro Home"
Fan or light turning on or off by themselves	<ol style="list-style-type: none"> Confirm the circuit breaker is not malfunctioning. Verify the wire connections are not frayed. Check the app is not set the timer or schedule Cut the fan power for 10 minutes then power on again. All the pins wiring on the circuit board are inserted tight and in the right position.



ITEM: ADC525D1L1/ADC565D1L1

Technical Parameter: AC 120V 60Hz

CEILING FAN INSTALLATION GUIDE

Please read and follow all the Instructions carefully before using this product
The product image shown here is indicative only.
Actual product you receive may differ.