

User Manual



Redefining Comfort, Elevating Workspace.

This manual is designed to help you assemble, adjust, and maintain your ergonomic chair with ease, ensuring maximum comfort and performance.

Safety Instructions

Before Use:







- Ensure all parts are properly assembled.
- Place the chair on a flat, stable surface.









-Warnings:

- Do not exceed the weight limit (specify weight limit, e.g., 350lbs/157 kg).
- Keep small parts away from children.
- Avoid sitting on the armrests or backrest.

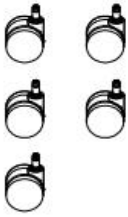
Hardware and Tool List

A (M6*55MM)	B(M6*40MM)	C (M6*45MM)	D (M8*25MM)
x6	x2	x2	x3
			
E	F	Allen Key	
x13	x3	x1	
			

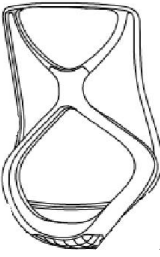
Parts List

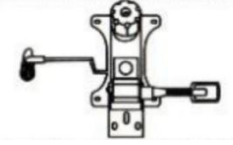
Castor	Base	Gas lift	Scat Cushion
x5	x1	x1	x1
			
Backrest	Armrests	Mechanism	
x1	x2	x1	
			

Assembly Instructions

Dear Valued Customer,

We understand that many ergonomic chairs can present challenges during installation. Please scan the QR code provided on the right to view the detailed installation video.

Should you encounter any issues, please click on the email address provided below the video to contact our support team. We are committed to providing you with the highest quality assistance and service.





We will provide you with a pair of gloves for you to use during installation

Step 1





Install chair armrests

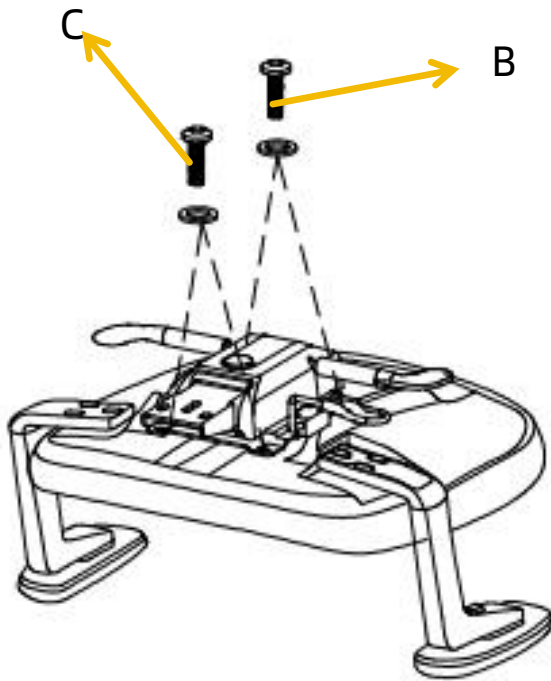

Required Accessories		
Accessory code	Image	Quantity
E		6
A		6
		1





Fix the armrest to the seat cushion with 6pcs(E) small shim and 6pcs(A) screws.

Step 2**Fix the mechanism**

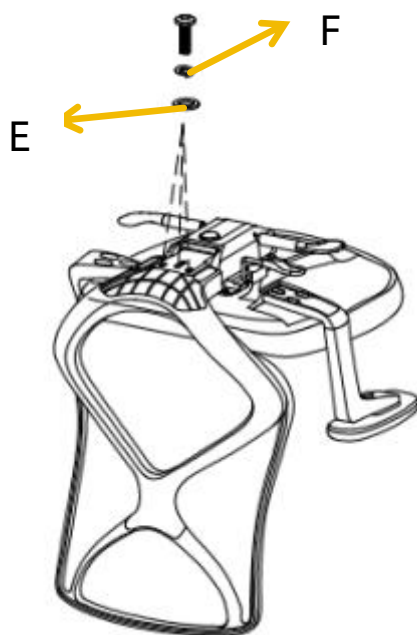
Required Accessories		
Accessory code	Image	Quantity
E		4
B		2
C		2
		1

Fix the mechanism to the seat cushion with 4pcs small shim , 2pcs(B) and 2pcs(C) screws.

Step 3

Required Accessories		
Accessory code	Image	Quantity
E		3
F		3
D		3
		1

Fix the backrest to the seat cushion with 3pcs big shim, 3pcs small shim and 3pcs(D)screws

Step 4



Insert castor into the Base (requires some effort)

Step 5

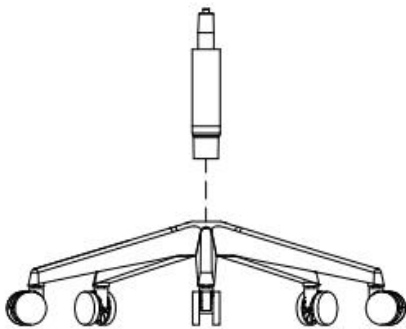

Insert the gas lift to the base.

Step 6

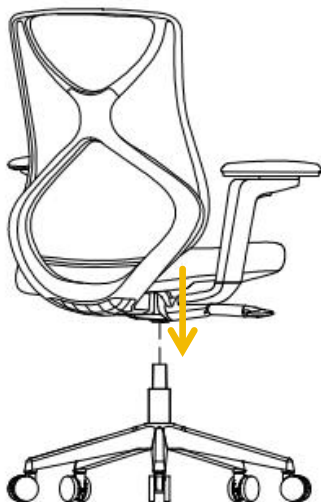

Put the mechanism into the gas lift. And then you get a new chair!

Adjustment Points



Maintenance and Cleaning

Provide care tips to maintain the chair's longevity:

1. **Cleaning:** Use a soft, damp cloth with mild soap for cleaning. Avoid harsh chemicals.
2. **Inspection:** Periodically check and tighten screws and bolts.
3. **Storage:** If not in use, store the chair in a cool, dry place to prevent wear and tear.

Troubleshooting

1. Problem: Chair does not recline.

-Solution: Check if the recline lock is engaged and disengage it.

2. Problem: Wheels are stuck.

-Solution: Remove wheels, clean out debris, and reattach them.

3. Problem: Chair wobbles.

-Solution: Ensure all screws are securely tightened.