

Tall Cabinet

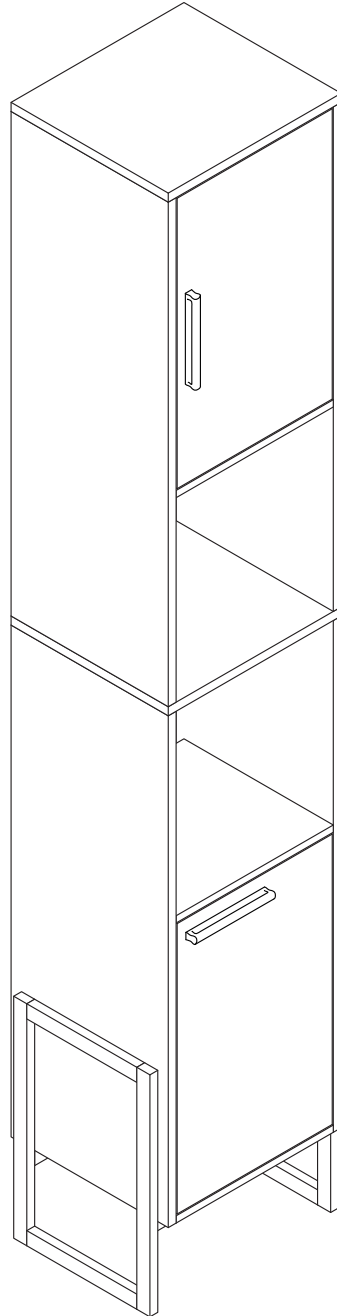

EN

WARNING

Serious or fatal injury may occur from unexpected assembly or use.

1. During the assembly process, keep all parts away from babies or children.
2. Always securely fix this product to the wall. Make sure the wall area to be drilled is free from hidden electrical wires, water and gas pipes.
3. Use of tip-over restraints may only reduce, but not eliminate the risk of tip-over.
4. Unless specially designed to accommodate, do not set heavy objects on top of this product.
5. Place the heaviest items on the lowest shelf.
6. Never allow children to climb or bang on drawers, doors or shelves.

DE

WARNUNG



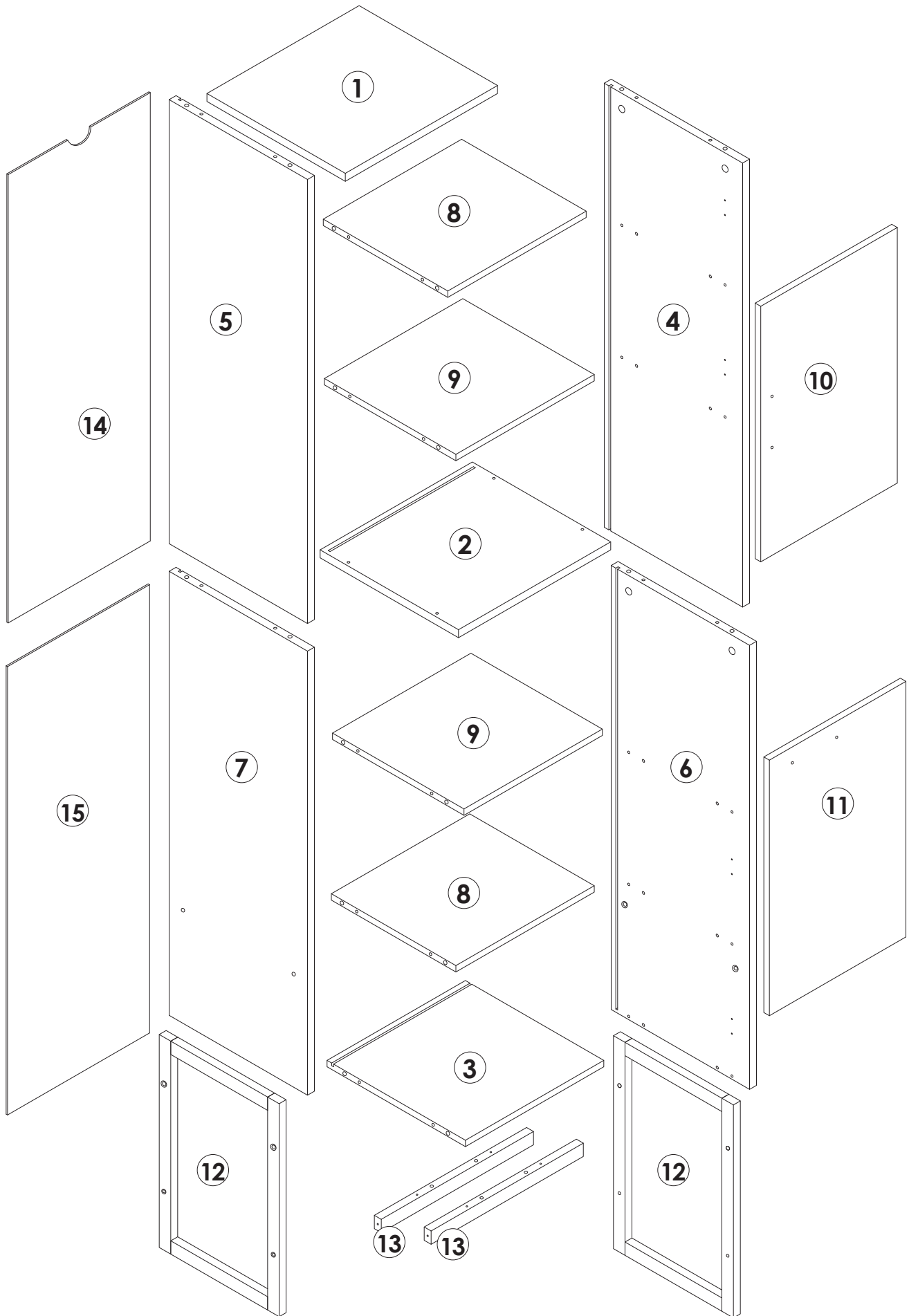

Bei unerwarteter Montage oder Verwendung können schwere oder tödliche Verletzung auftreten.

1. Legen Sie in den Montageprozess alle Teile weg von Babys oder Kindern.
2. Stellen Sie sicher, dass der gebohrte Wandbereich frei von verborgenen Stromkabeln, Wasser- und Gasleitungen ist, wenn Sie dieses Produkt an der Wand befestigen.
3. Die Verwendung von Kippsicherungen kann die Gefahr eines Kippens nur verringern, jedoch nicht beseitigen.
4. Setzen Sie bitte keine schweren Gegenstände auf dieses Produkt, es sei denn, dass das Produkt speziell für die Unterbringung konzipiert wird.
5. Legen Sie bitte die schwersten Gegenstände auf das unterste Regal.
6. Erlauben Sie nie Kindern, auf Schubladen, Türen oder Regale zu klettern oder zu knallen.

Parts List(EN) / Teile Liste(DE)

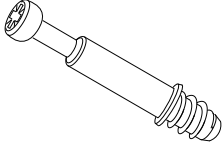
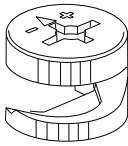
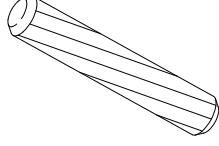
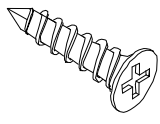
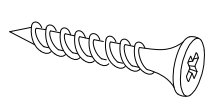
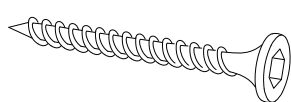
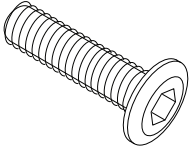
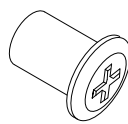
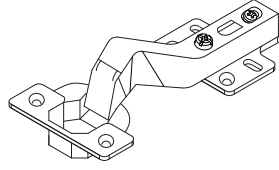
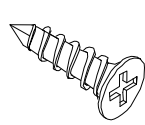
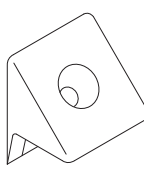
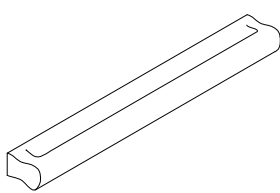

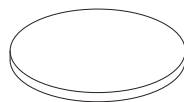

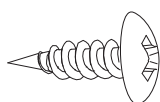
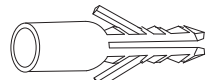
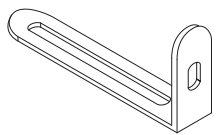
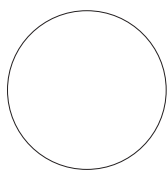



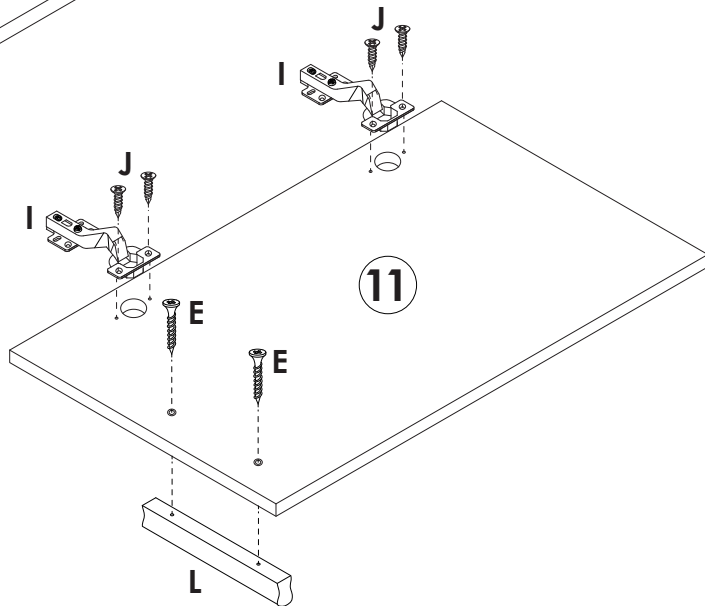
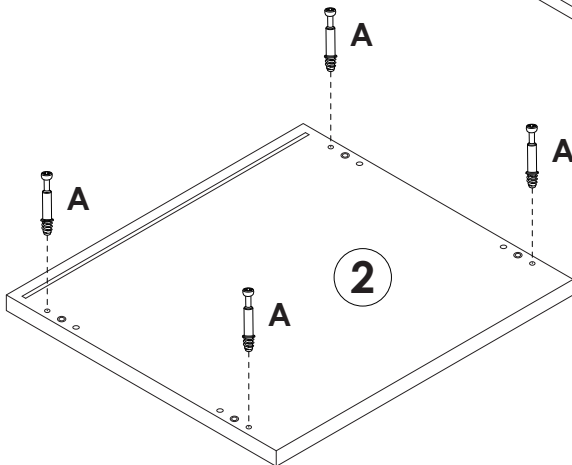
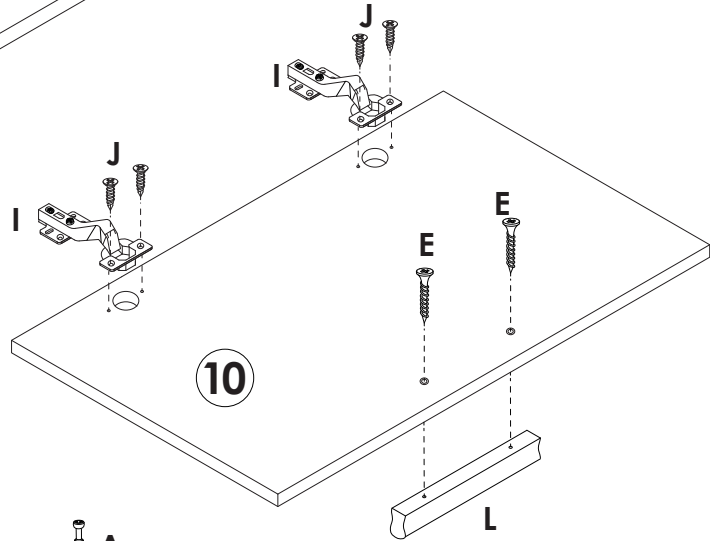
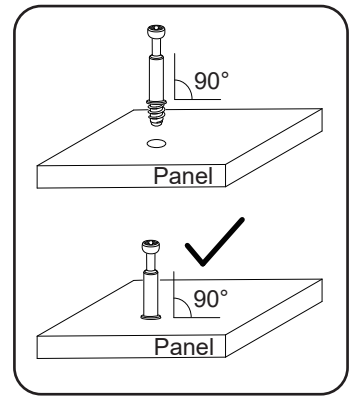
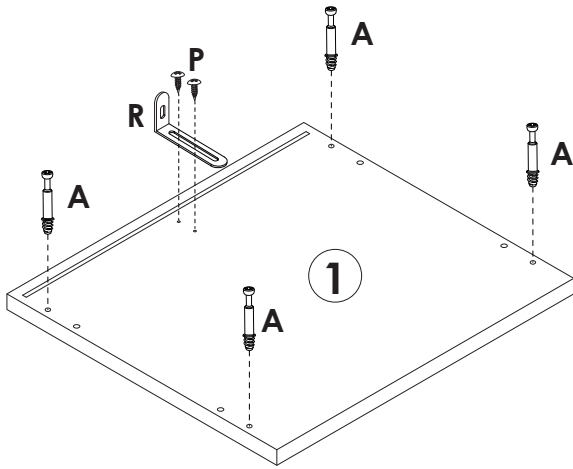

Parts List(EN) / Teile Liste(DE)

<p>A</p>  <p>M6x35mm 28+2PCS</p>	<p>B</p>  <p>Φ15x10mm 28+2PCS</p>	<p>C</p>  <p>Φ6x30mm 32+2PCS</p>
<p>D</p>  <p>M3x14mm 8+1PCS</p>	<p>E</p>  <p>M4x25mm 4PCS</p>	<p>F</p>  <p>M5x40mm 4PCS</p>
<p>G</p>  <p>M6x25mm 4PCS</p>	<p>H</p>  <p>Φ8x12mm 4PCS</p>	<p>I</p>  <p>4PCS</p>
<p>J</p>  <p>M4x12mm 24+2PCS</p>	<p>K</p>  <p>8+1PCS</p>	<p>L</p>  <p>2PCS</p>
<p>M</p>  <p>M4 1PC</p>	<p>N</p>  <p>4PCS</p>	<p>O</p>  <p>M4x35mm 9+1PCS</p>
<p>P</p>  <p>M4x12mm 2PCS</p>	<p>Q</p>  <p>1PC</p>	<p>R</p>  <p>1PC</p>
<p>S</p>  <p>20+2PCS</p>		

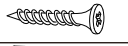
Assembly Steps(EN) / Montageschritte(DE)

STEP 1



	A x 8PCS
	E x 4PCS
	I x 4PCS
	J x 8PCS
	L x 2PCS
	P x 2PCS
	R x 1PC

Assembly Steps(EN) / Montageschritte(DE)

STEP 2

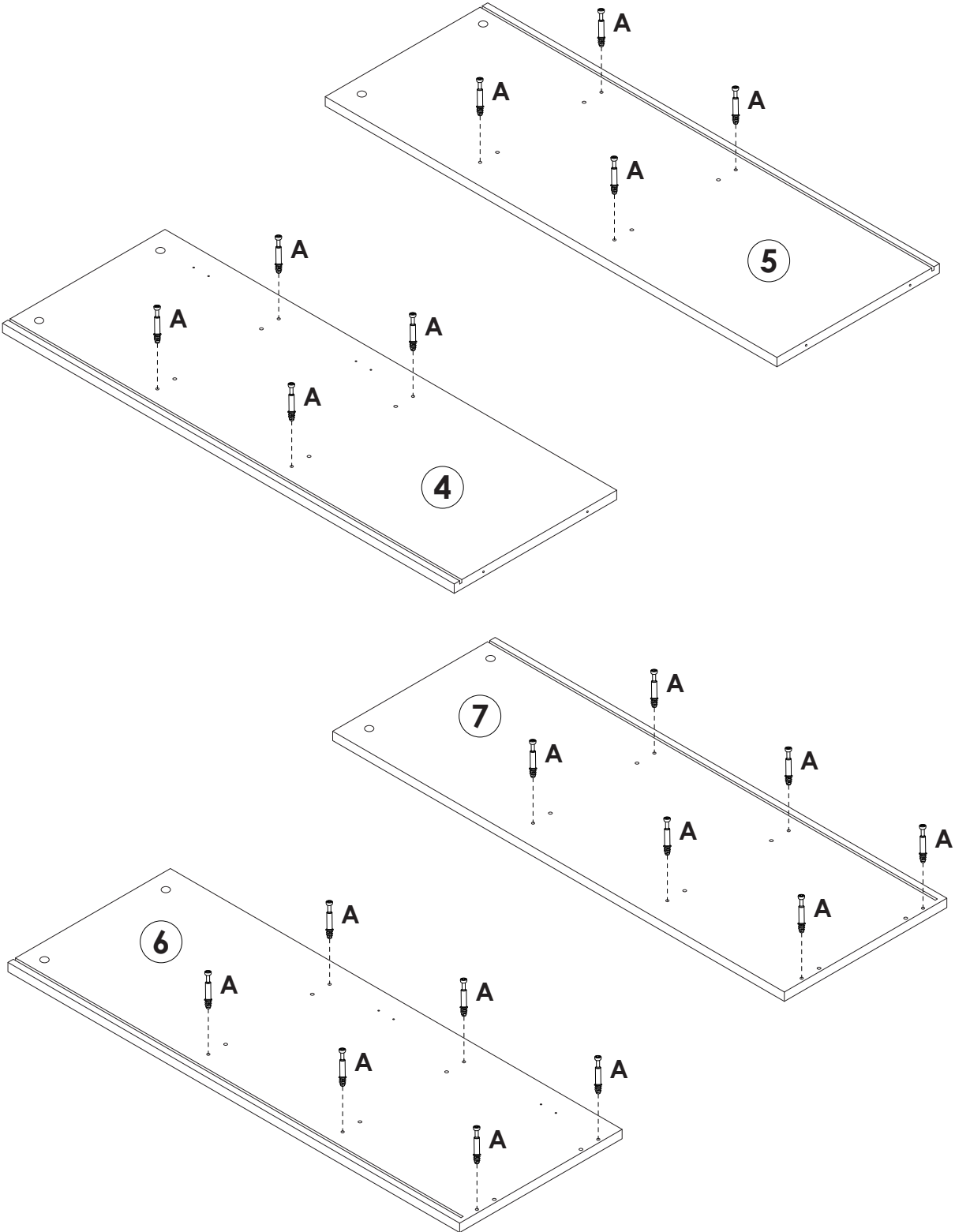



 **A** x 20PCS

Assembly Steps(EN) / Montageschritte(DE)

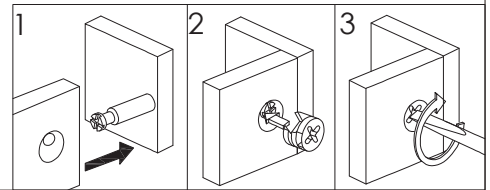
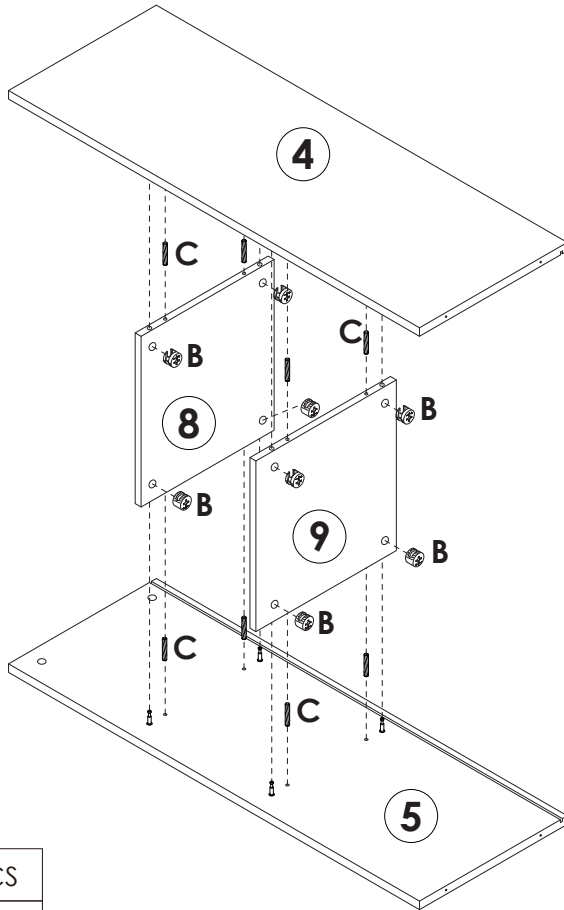

STEP 3

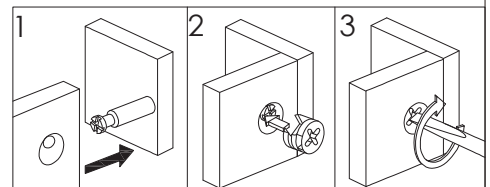
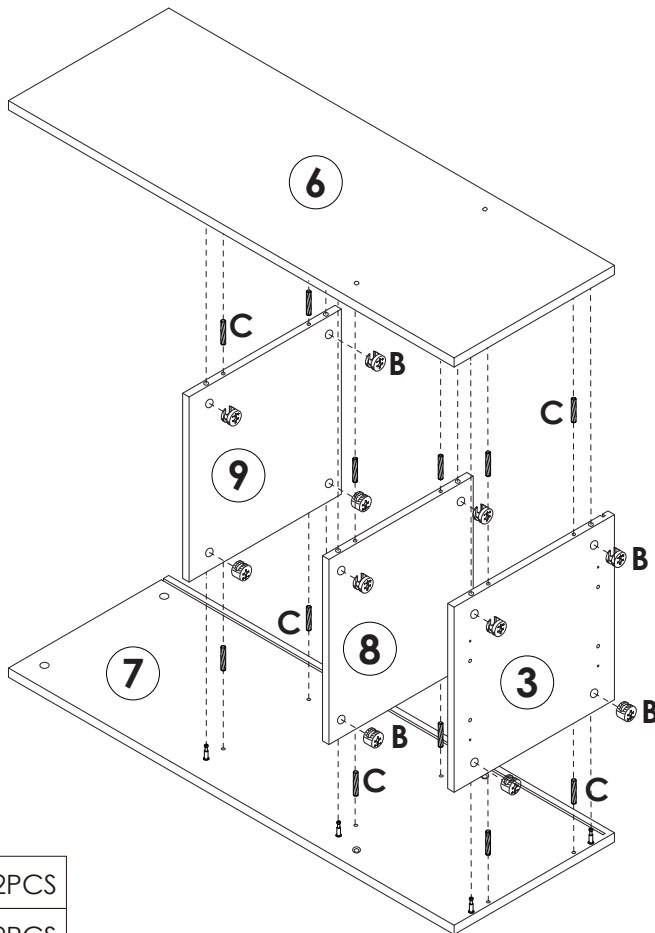

	B x 8PCS
	C x 8PCS

STEP 4



	B x 12PCS
	C x 12PCS

Assembly Steps(EN) / Montageschritte(DE)

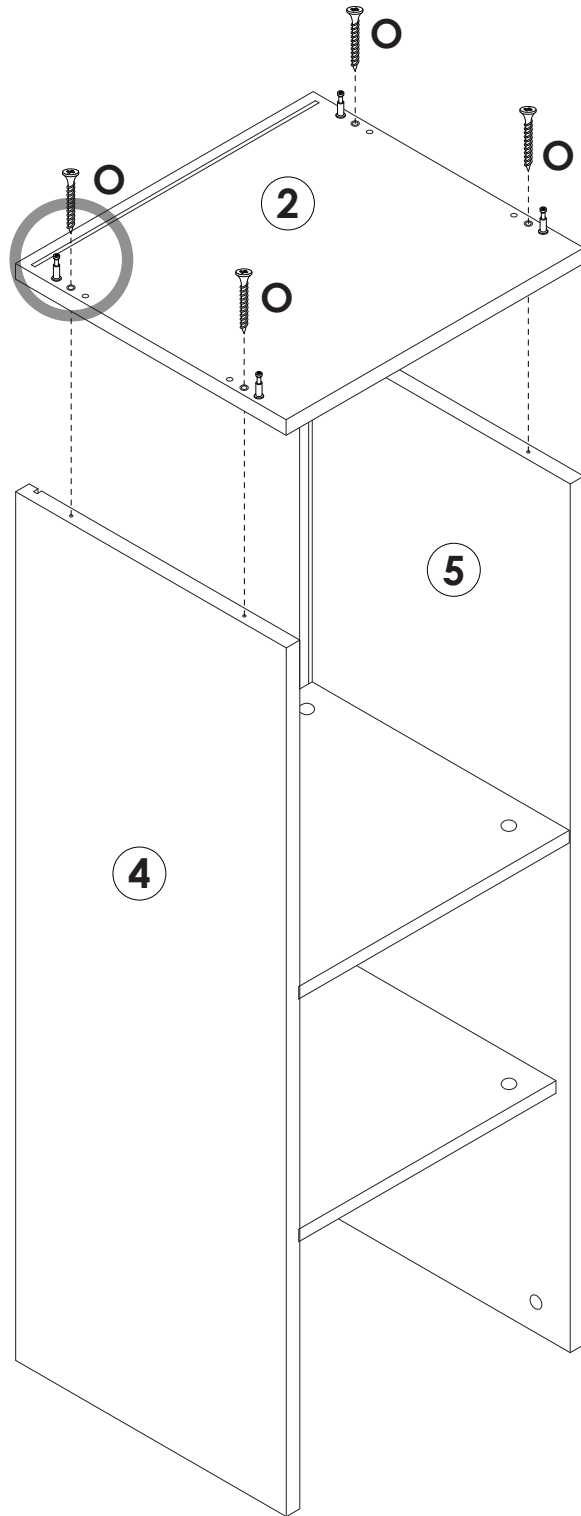
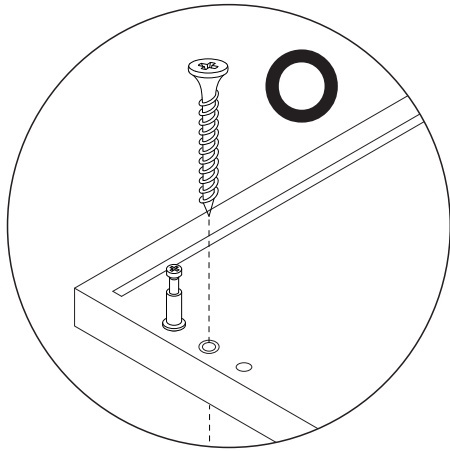

STEP 5

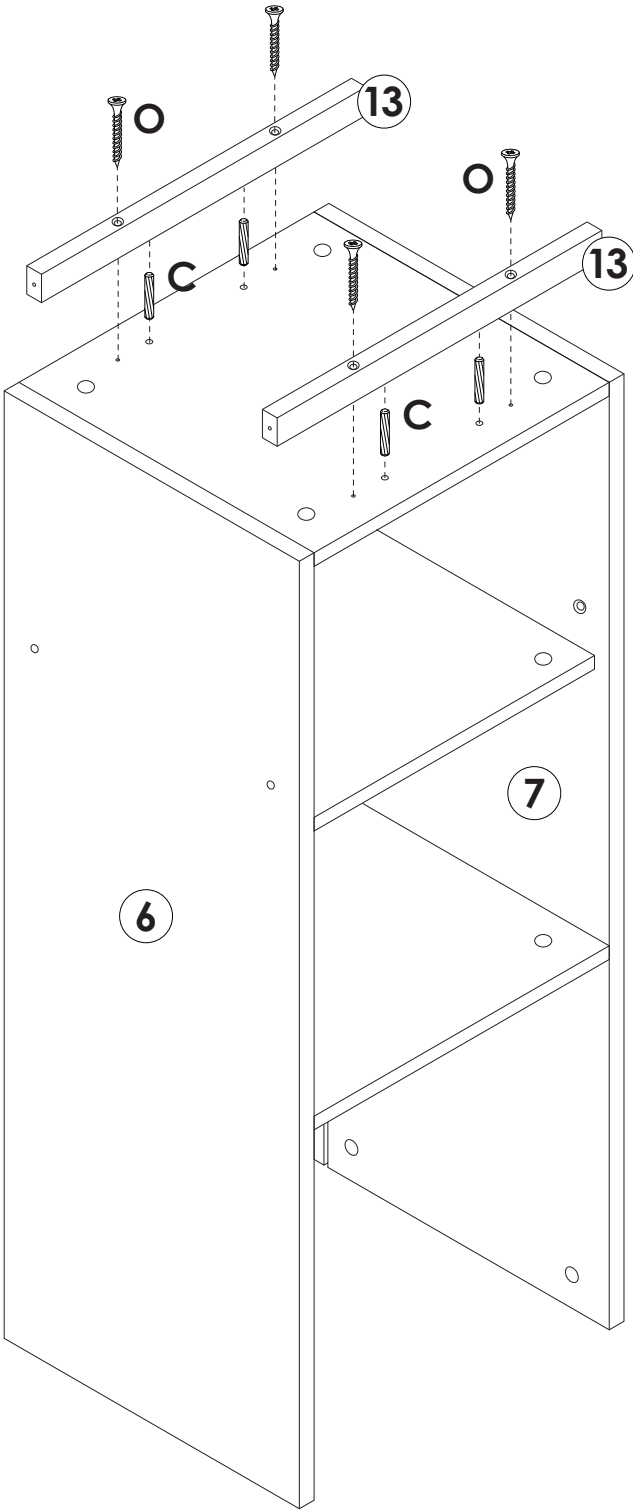

Assembly Steps(EN) / Montageschritte(DE)

STEP 6





	C x 4PCS
	O x 4PCS

Assembly Steps(EN) / Montageschritte(DE)

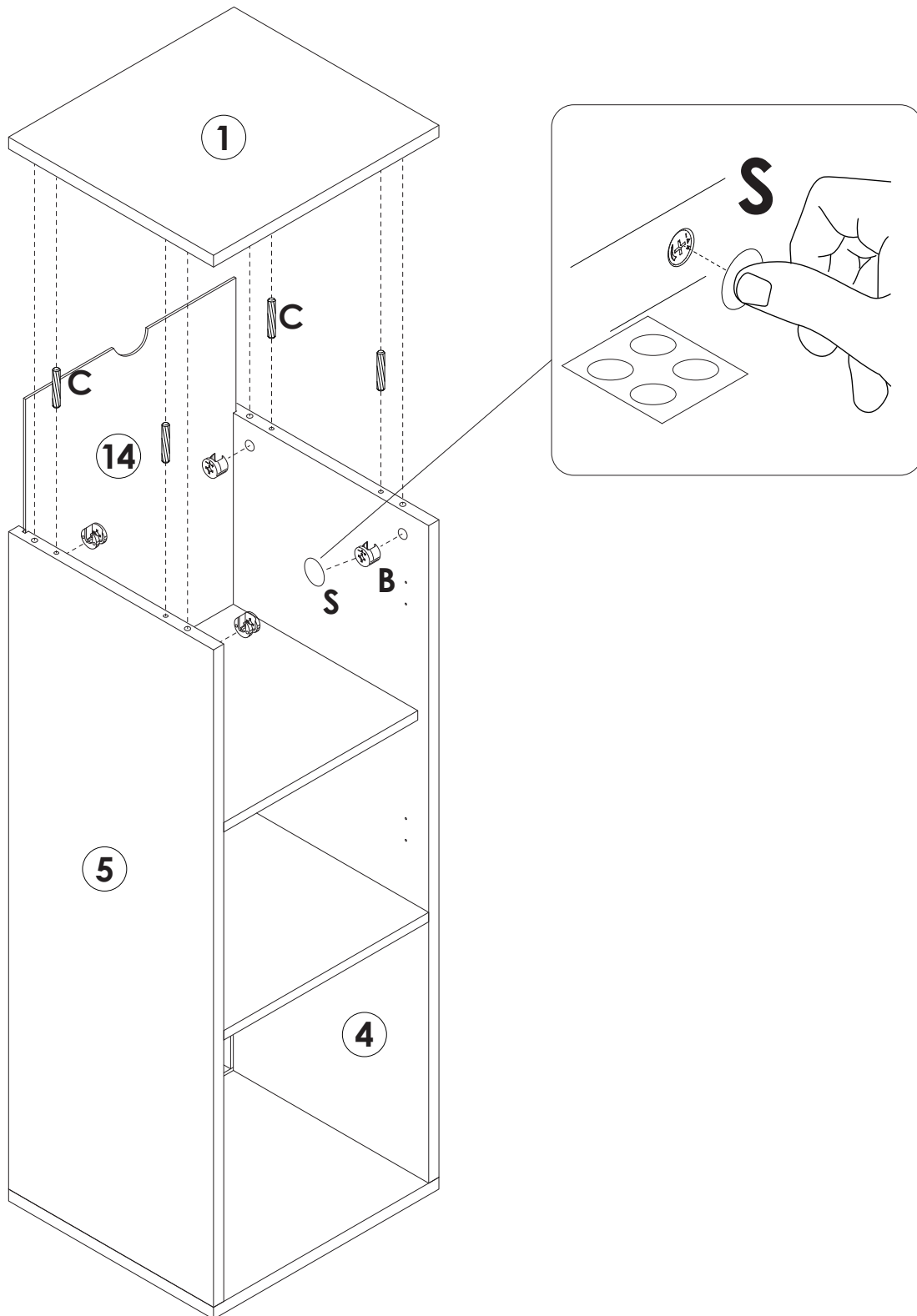
STEP 7





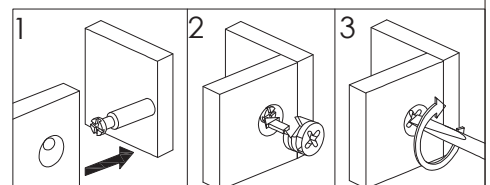



	B x 4PCS
	C x 4PCS
	S x 4PCS

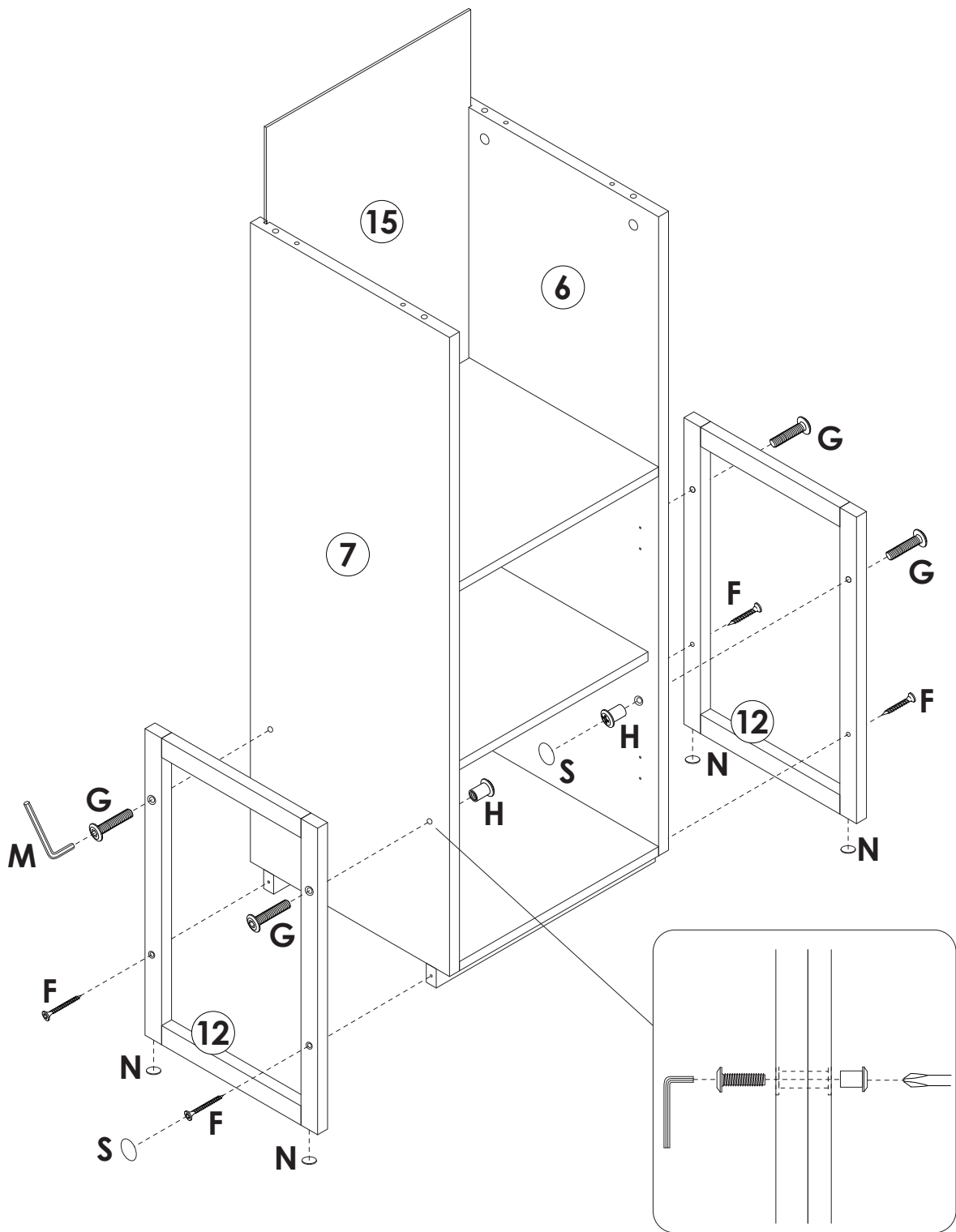

Assembly Steps(EN) / Montageschritte(DE)

STEP 8

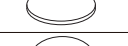



	F x 4PCS
	G x 4PCS
	N x 4PCS
	M x 1PC
	N x 4PCS
	S x 12PCS

Assembly Steps(EN) / Montageschritte(DE)

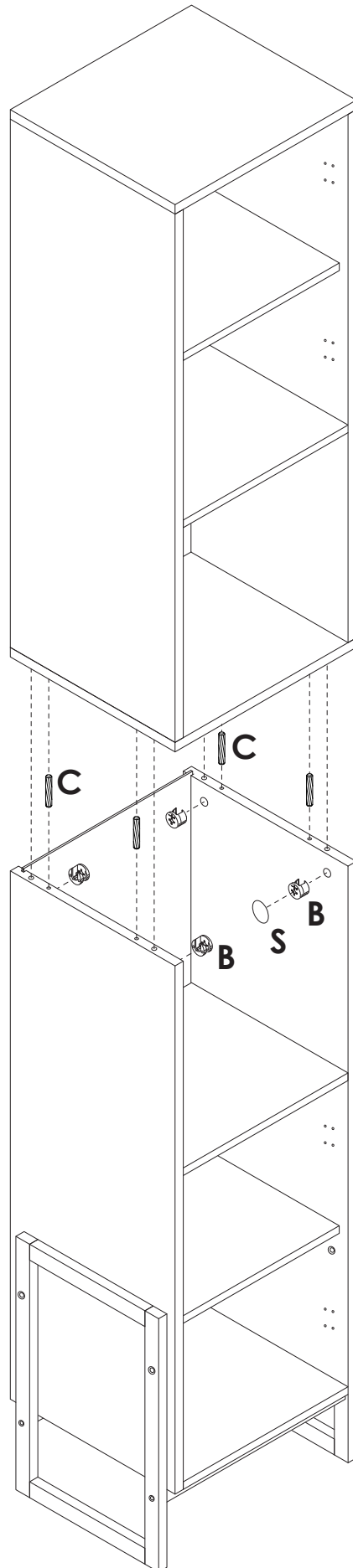
STEP 9



	B x 4PCS
	C x 4PCS
	S x 4PCS

Assembly Steps(EN) / Montageschritte(DE)

STEP 10

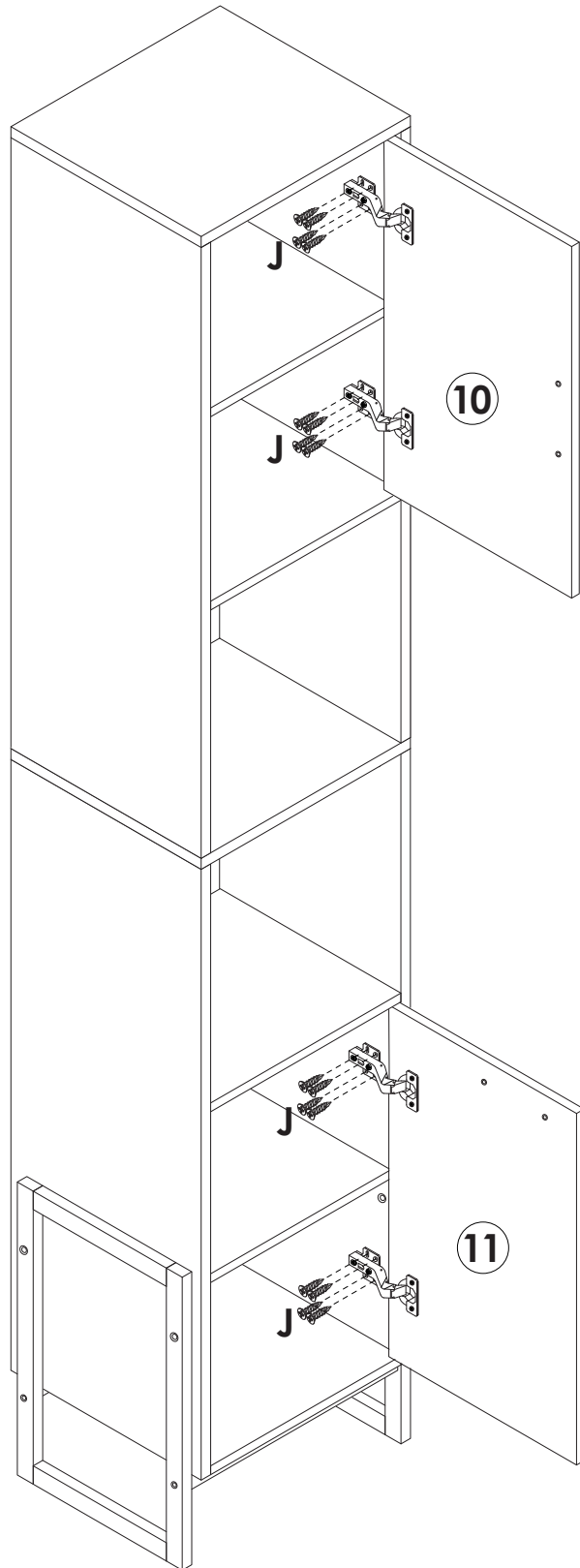
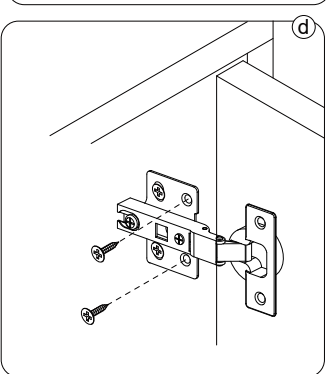
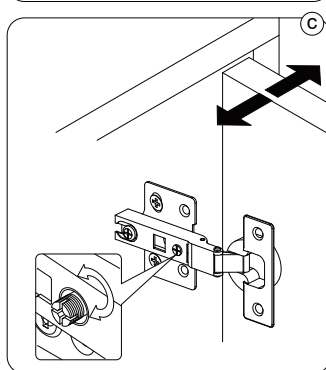
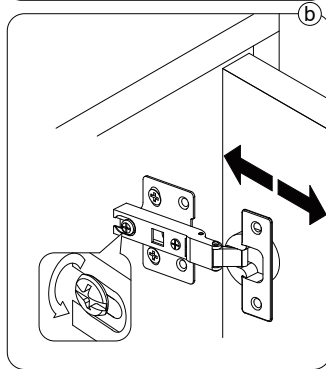
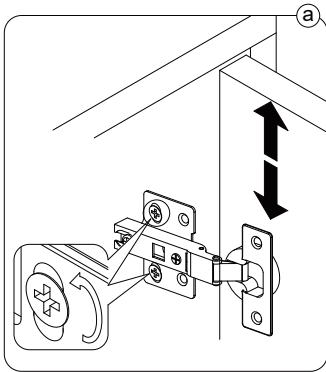

J x 16PCS

Assembly Steps(EN) / Montageschritte(DE)

STEP 11

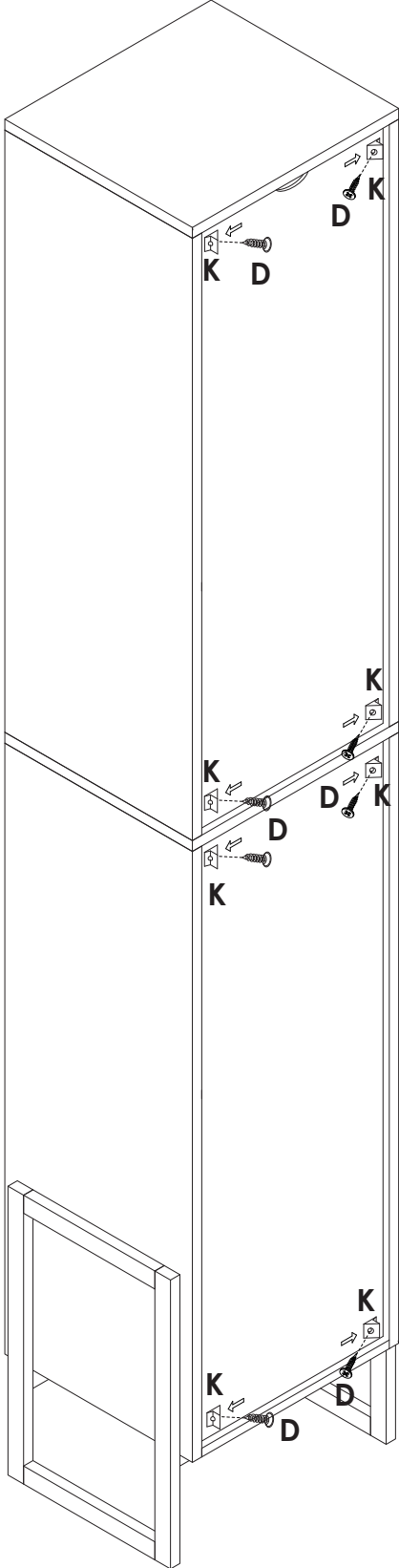



	D x 8PCS
	K x 8PCS

Assembly Steps(EN) / Montageschritte(DE)

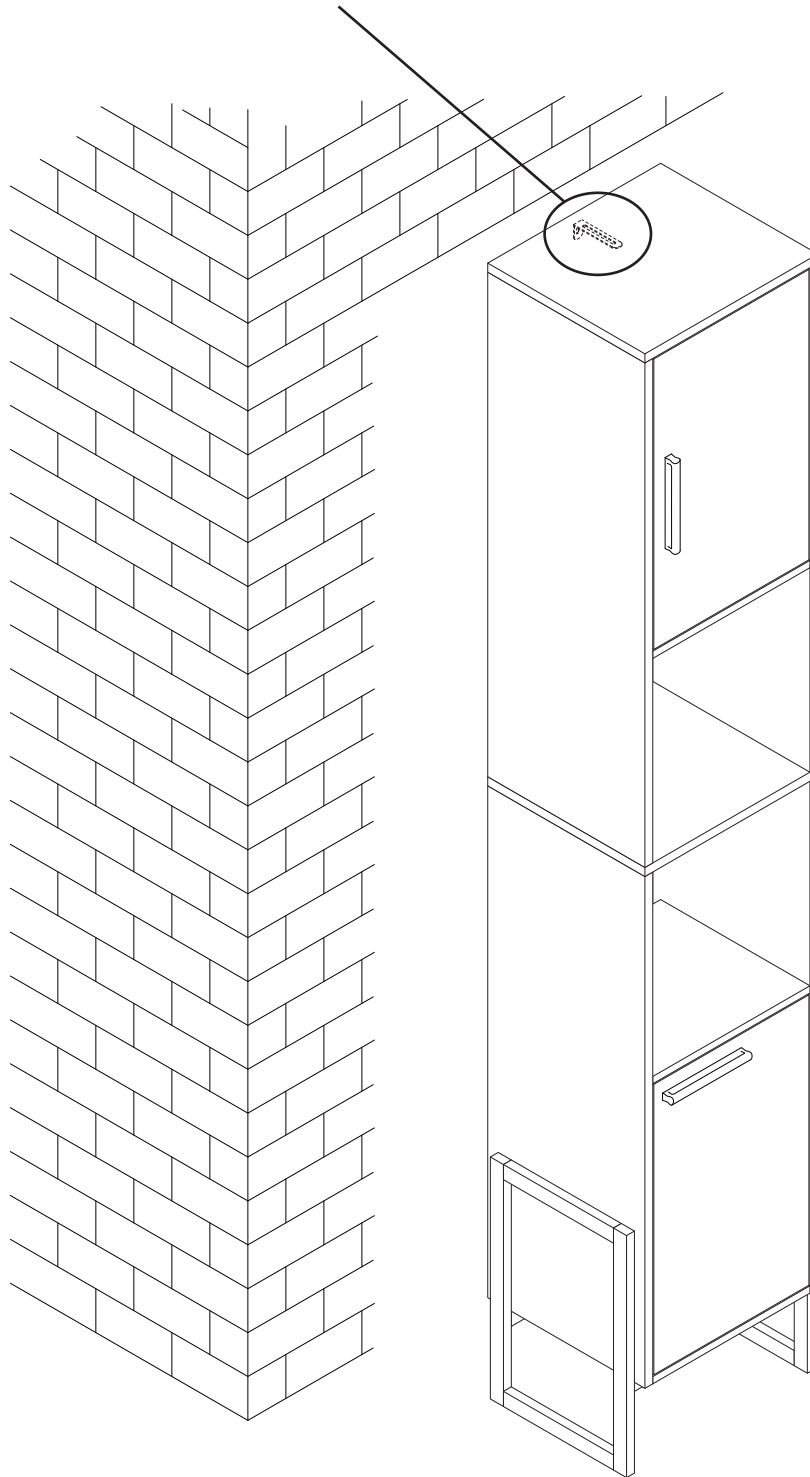
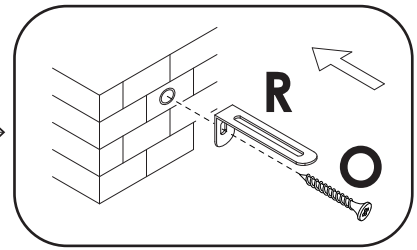
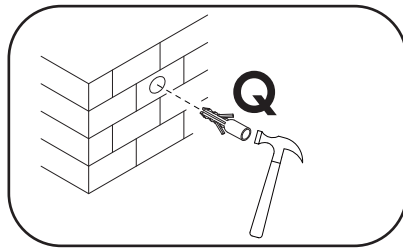
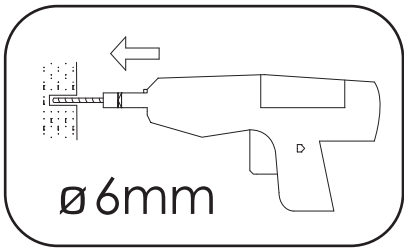
STEP 12

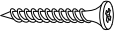

	O x 1PC
	Q x 1PC