

As this item contains many parts, please read the installation instruction carefully before installation . Please use tools properly and carefully. If you have any questions about the product and installation, please contact us.

Our professional after-sales team will serve you online all day.

# Before You Start

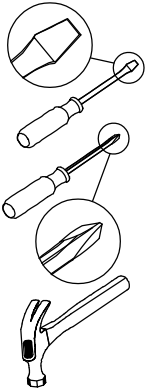

- ✓ Read through each step carefully and follow the proper order
- ✓ Separate and count all your parts and hardware
- ✓ Give yourself enough room for the assembly process
- ✓ Have the following tools: Flat Head Screwdriver, #2 Phillips Head Screwdriver and Hammer
- ✓ Caution: If using a power drill or power screwdriver for screwing, please be aware of to slow down and stop when screw is tight. Failure to do so may result in stripping the screw. (Assembly speed can be increased by using electric screwdriver)

# Helpful Hints

## PEOPLE NEEDED FOR ASSEMBLY: 1-2

- Open your item in the area you plan to keep it to avoid excessive heavy lifting.
- Identify, sort and count the parts before attempting assembly.
- Compression dowels are lightly tapped in with a hammer.
- Slides are labeled with an **R** (right) and **L** (left) for proper placement.
- Make sure to always face the point on the top of the Cam Lock towards the outer edge.
- If there is a back panel in the package, please install it to make sure your unit is complete and sturdy.
- Please fix all the screws provided for the back panel which can enhance product stability. If it is difficult to fix it when tightening, it can be fixed with the help of a hammer and then tightened.
- Do NOT use harsh chemicals or abrasive cleaners on this item.
- Never push, pull, or drag your furniture.



# Board Identification

Not actual size

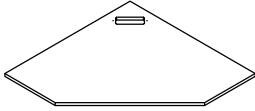
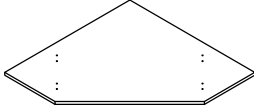
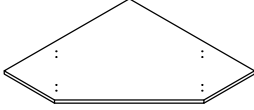
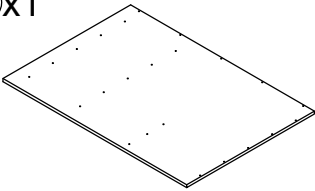
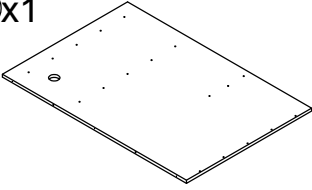
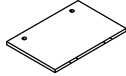
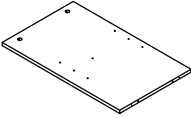
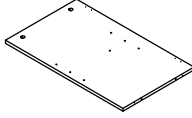
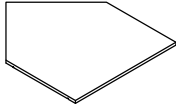
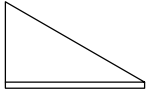
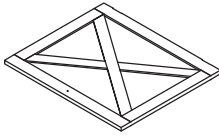
<p>①x1</p> 	<p>②x1</p> 	<p>③x1</p> 
<p>Roof</p>	<p>Laminate</p>	<p>Floor</p>
<p>④x1</p> 	<p>⑤x1</p> 	<p>⑥x2</p> 
<p>Left side panel</p>	<p>Right side panel</p>	<p>Upper partition</p>
<p>⑦x1</p> 	<p>⑧x1</p> 	<p>⑨x1</p> 
<p>Lower left partition</p>	<p>Lower right partition</p>	<p>Movable Shelf</p>
<p>⑩x2</p> 	<p>⑪x1</p> 	
<p>Edge layer board</p>	<p>Door plank</p>	

# Part List

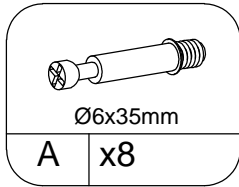

Cam Bolt

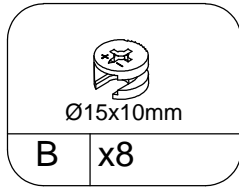

Cam Lock

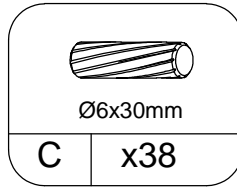

Dowel  
spare:2

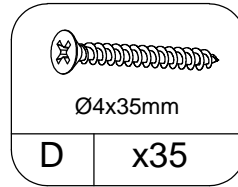

Flat Head Tapping Screw  
spare:2

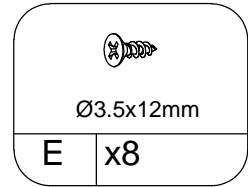

Sliding Track Screw

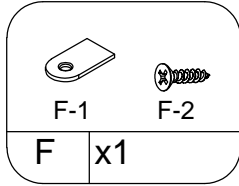

Single hole iron  
sheet and screw

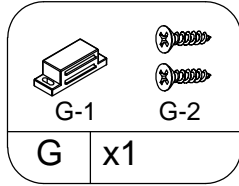

Magnetic collision  
and screw

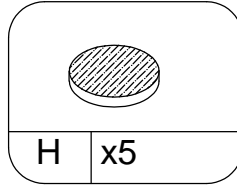

Foot pad

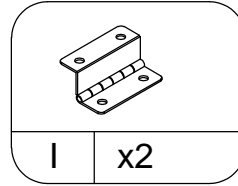

4-hole 3-page hinge

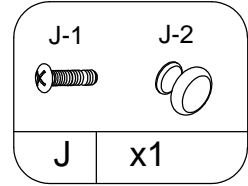

Handle screw  
and handle

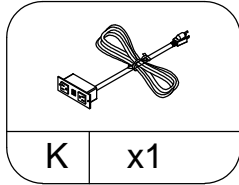

Socket

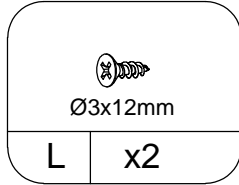

Screw

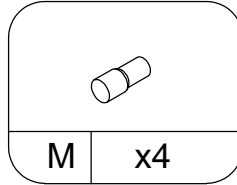

Lamina Torus

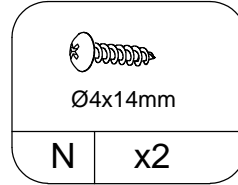

Round head screw

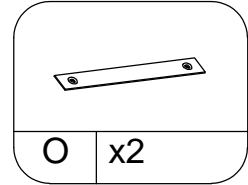

Anti-Fall Strip

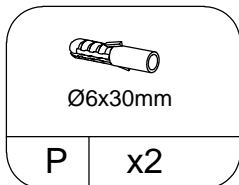

Plastic Expansion

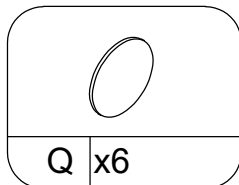

Hole sticker

# Part List

## Cam Lock Fastening System

Insert the cam bolt into the hole first, then insert the cam lock and lock it.

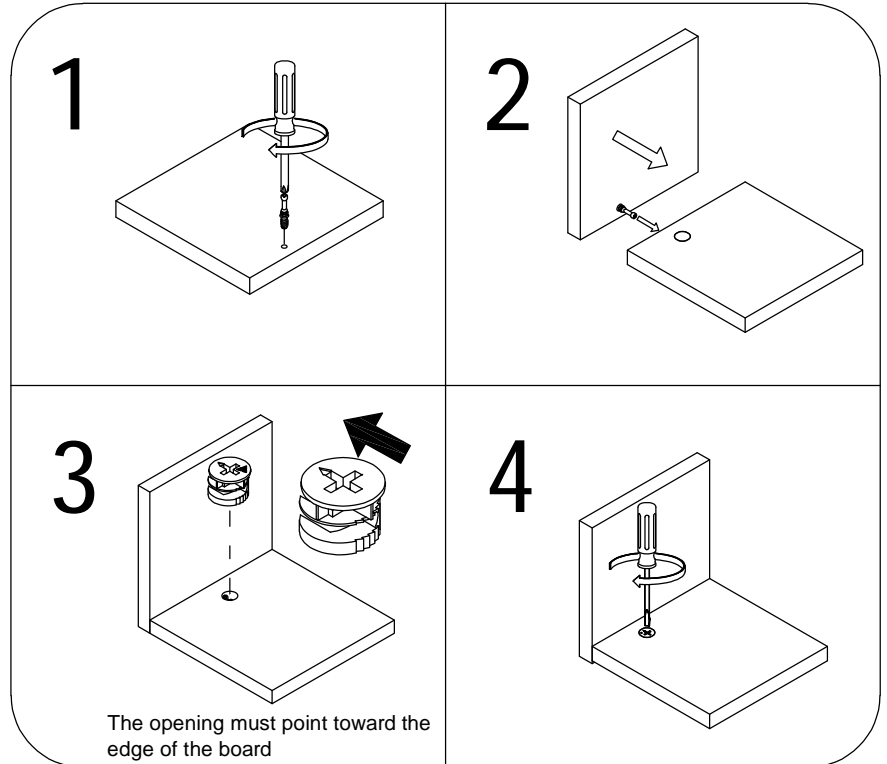

---

# Board Identification

Not actual size

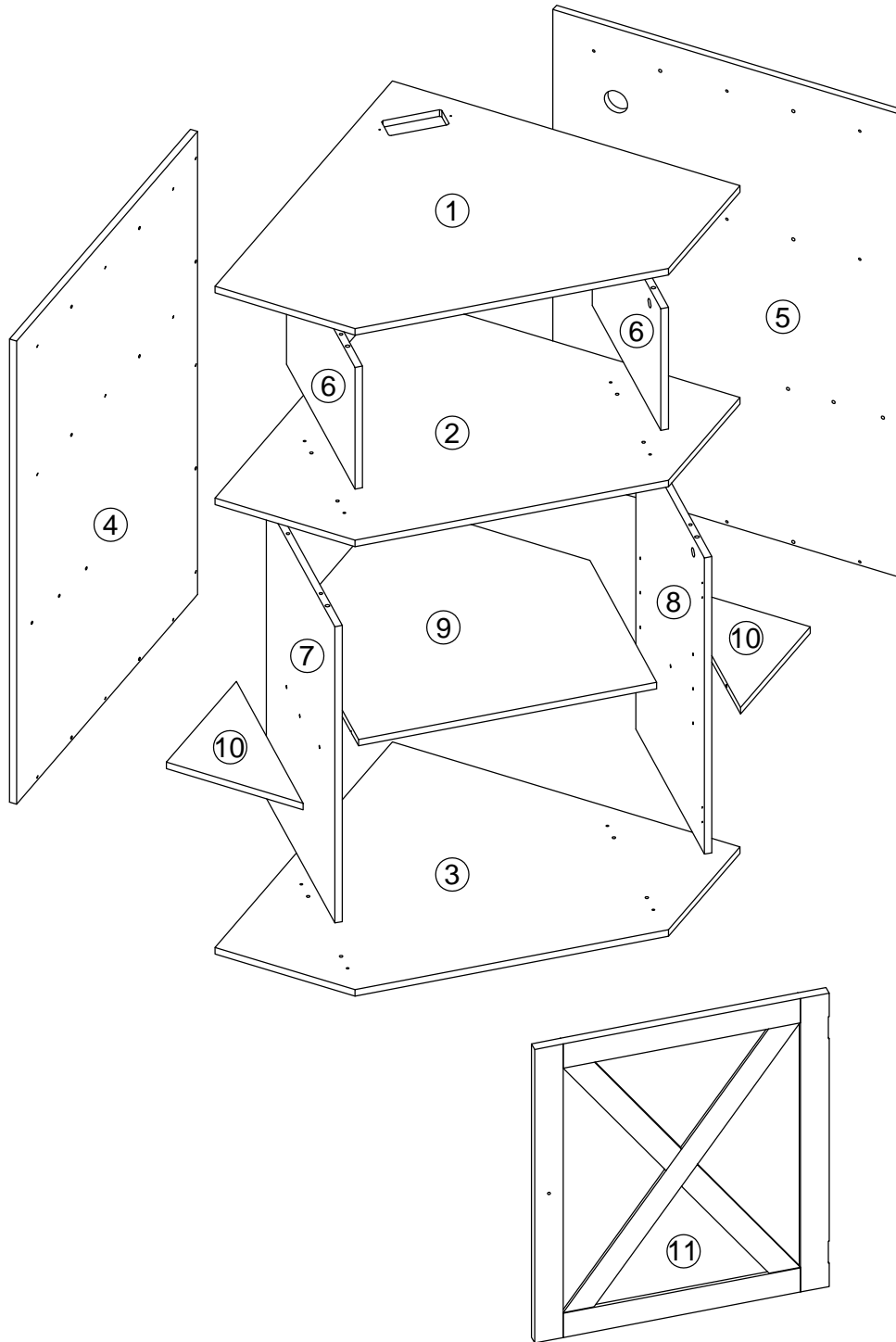

# STEP 1

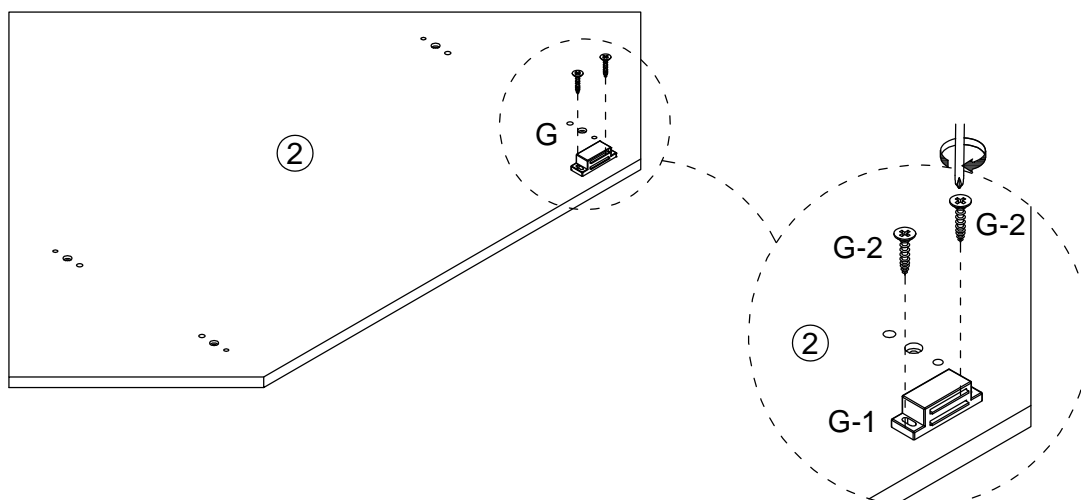
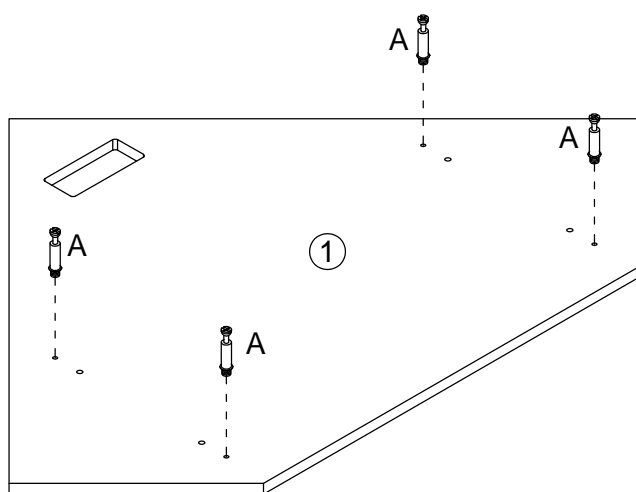
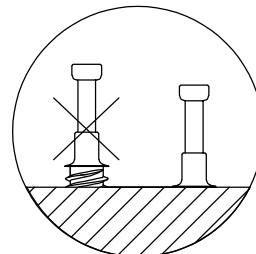
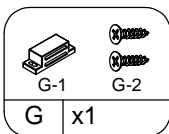
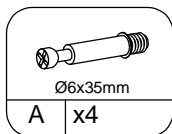
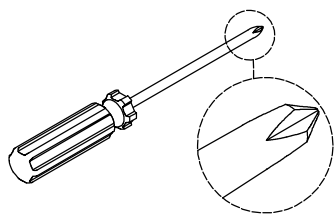

# STEP 2

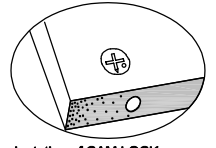
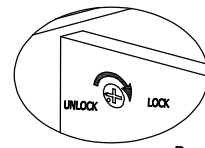
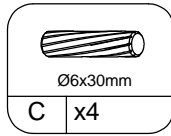
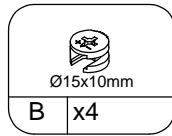
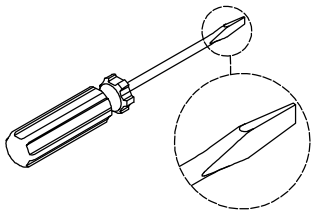

Proper orientation of CAM LOCK

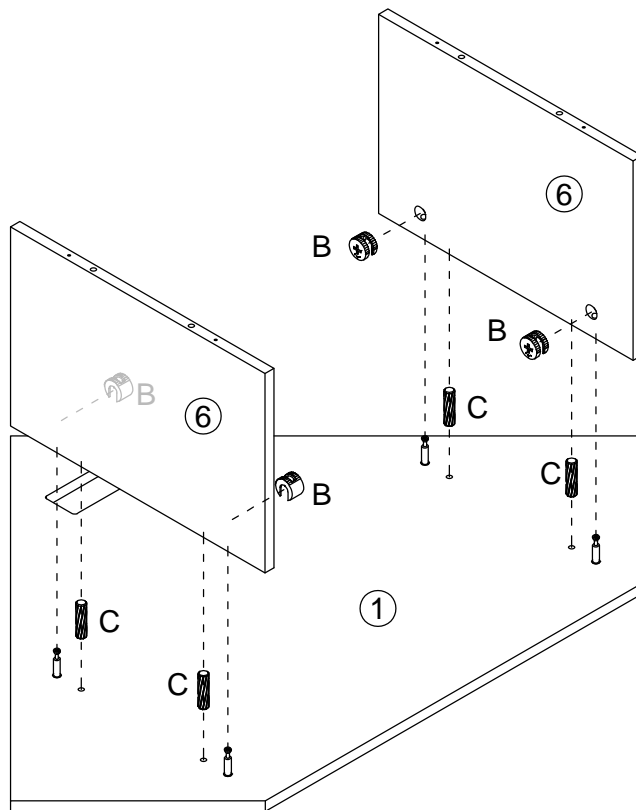

# STEP 3

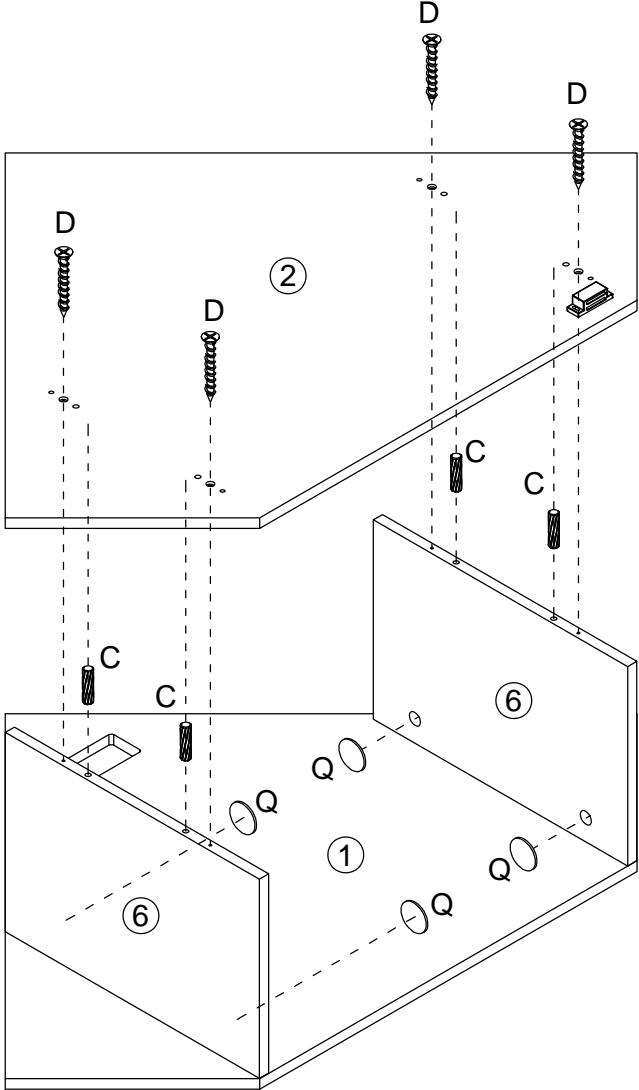
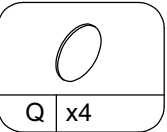
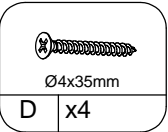
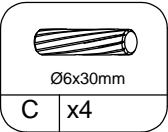
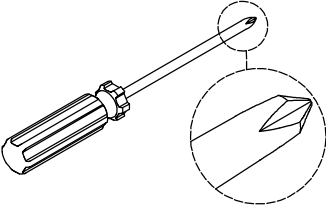

# STEP 4

---

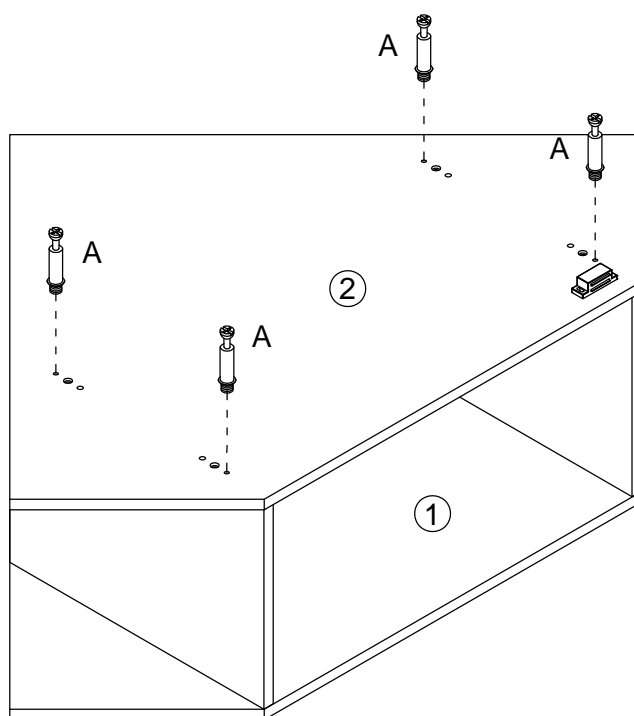
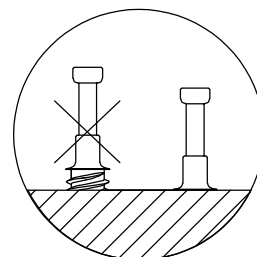
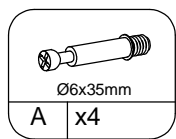
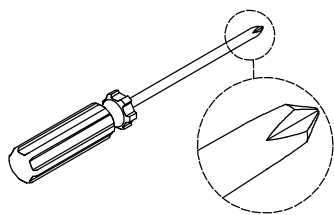

# STEP 5

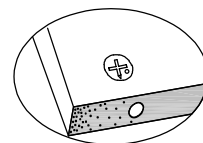
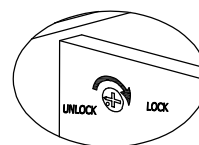
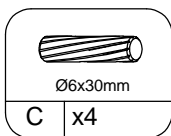
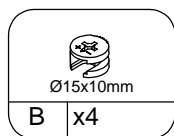
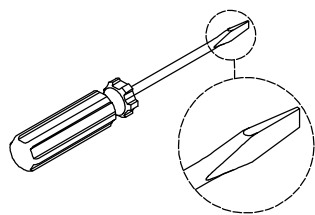

Proper orientation of CAM LOCK

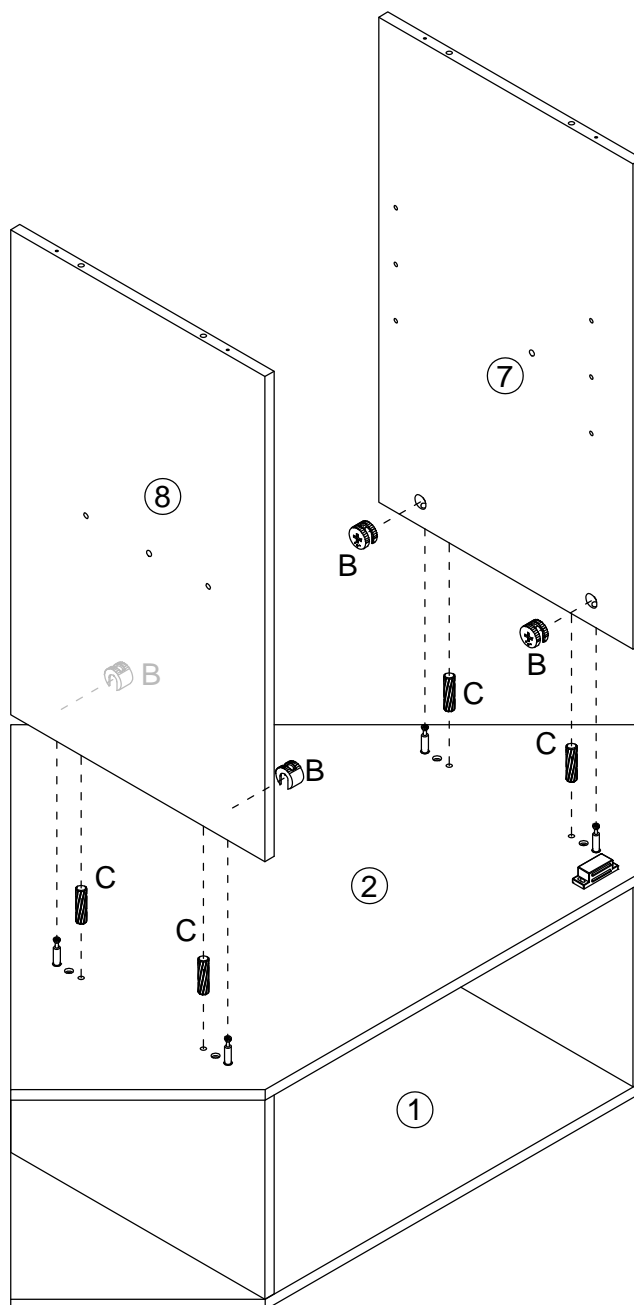

# STEP 6

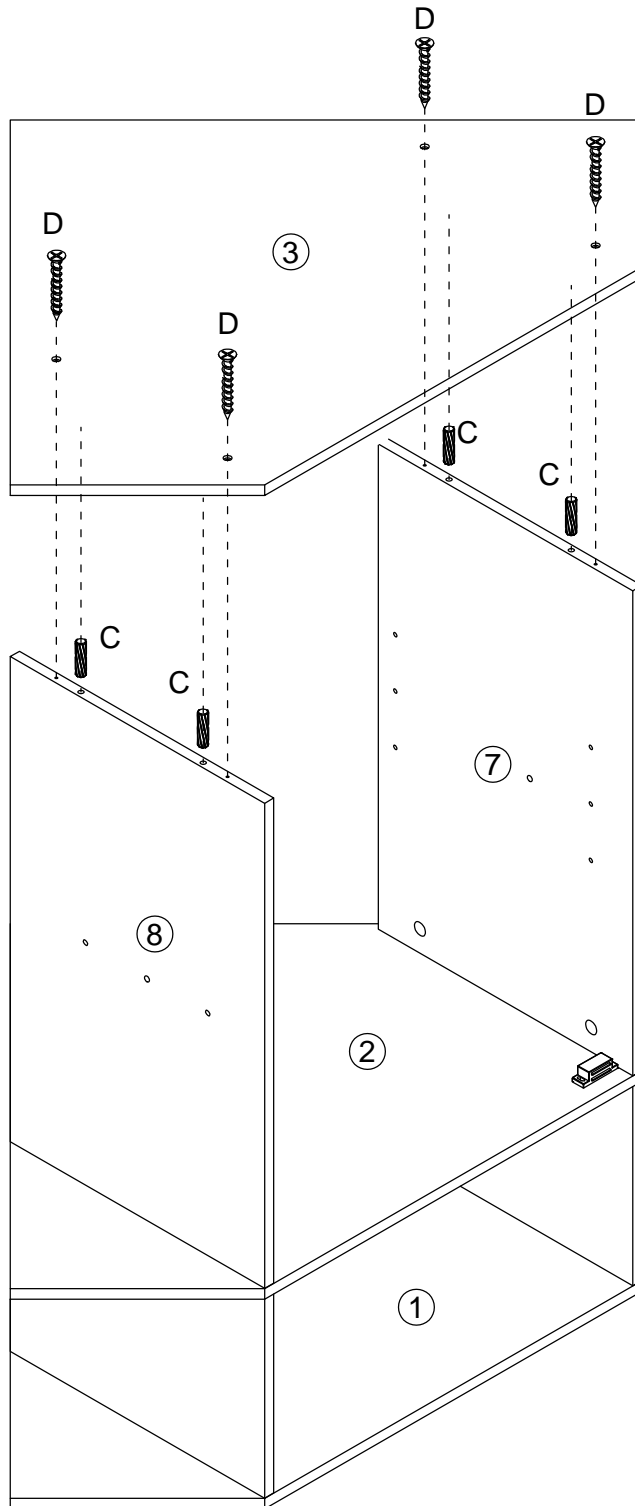
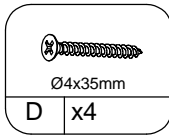
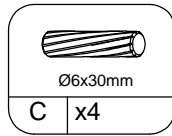
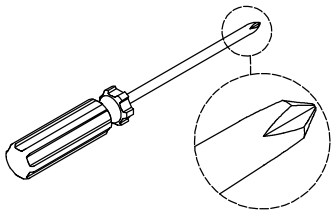

# STEP 7

---

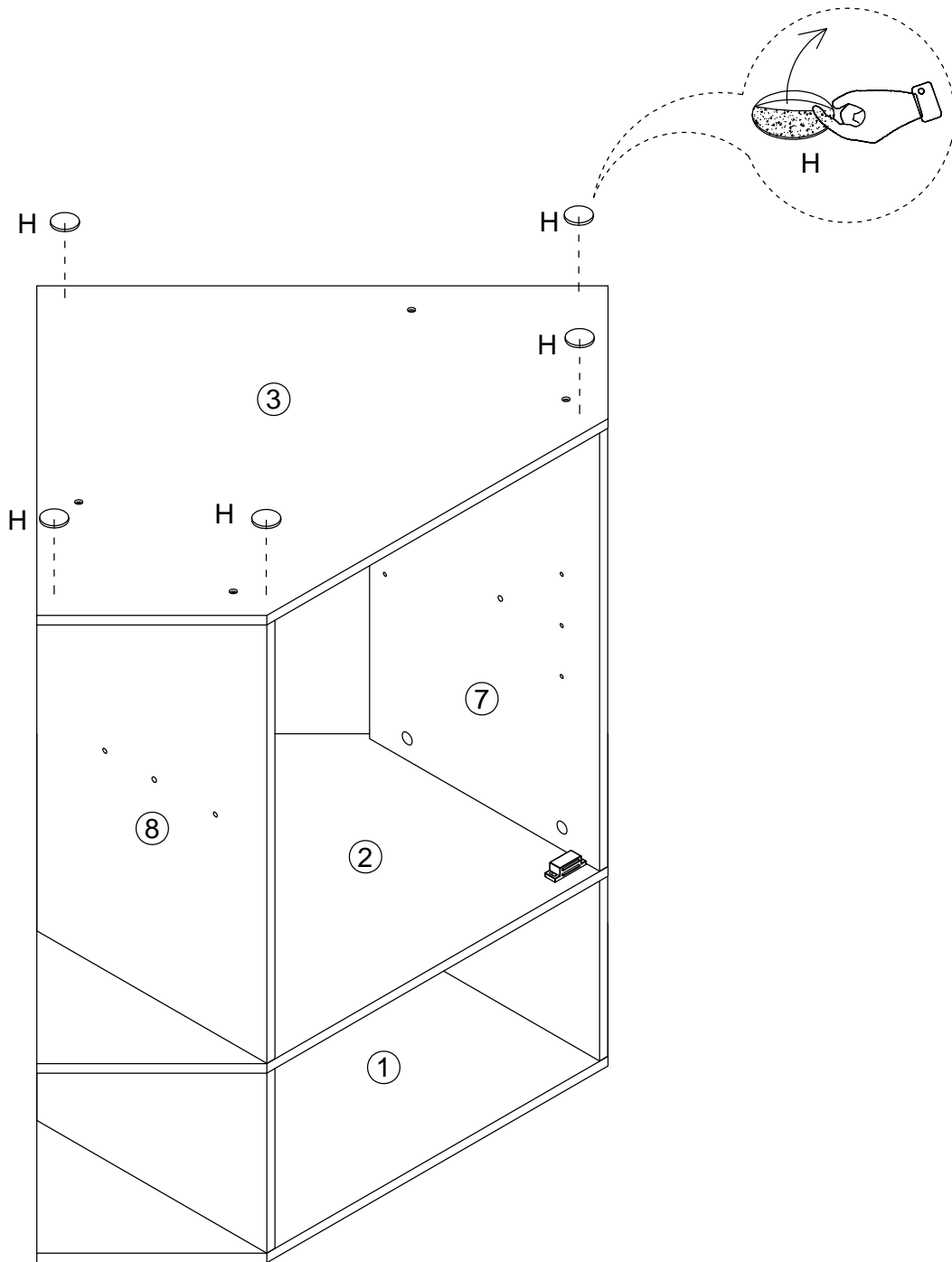
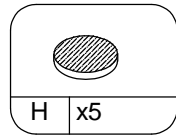

# STEP 8

---

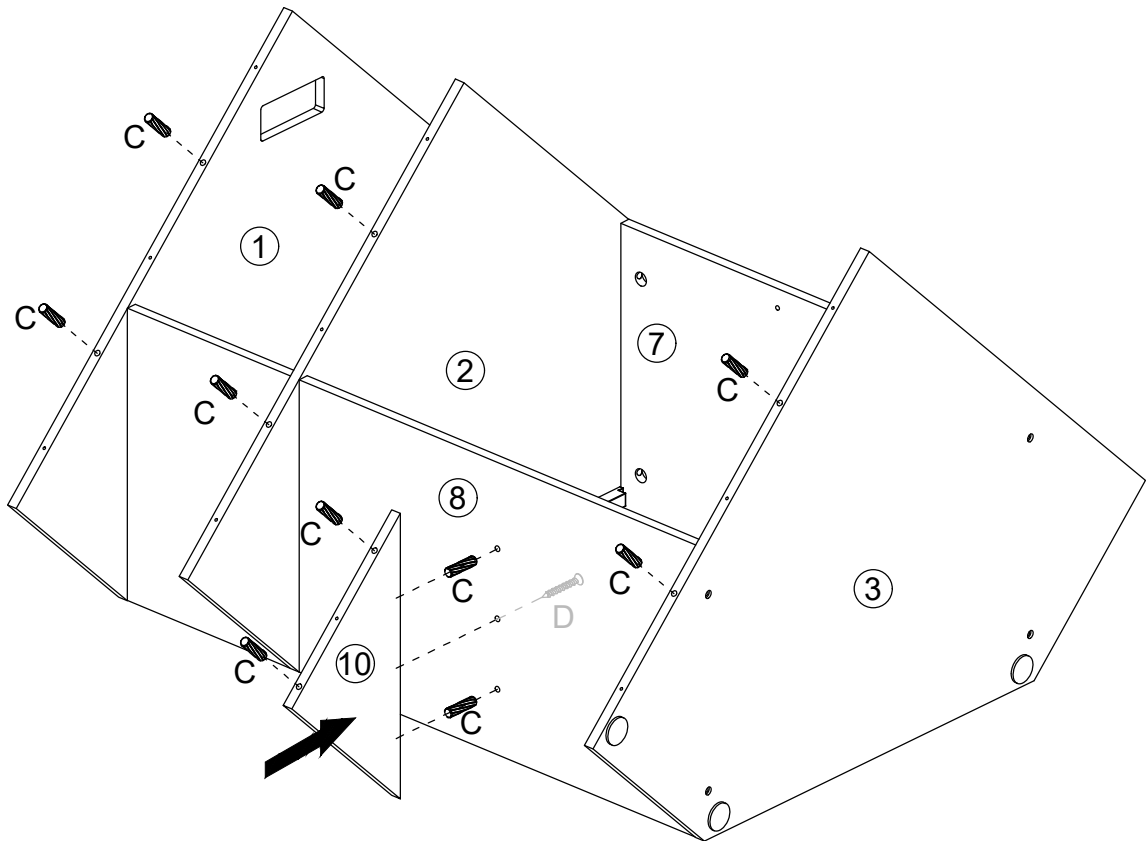
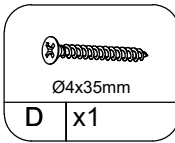
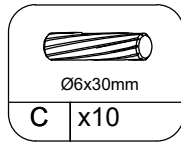
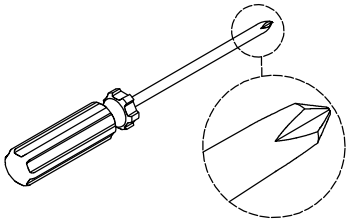

# STEP 9

---

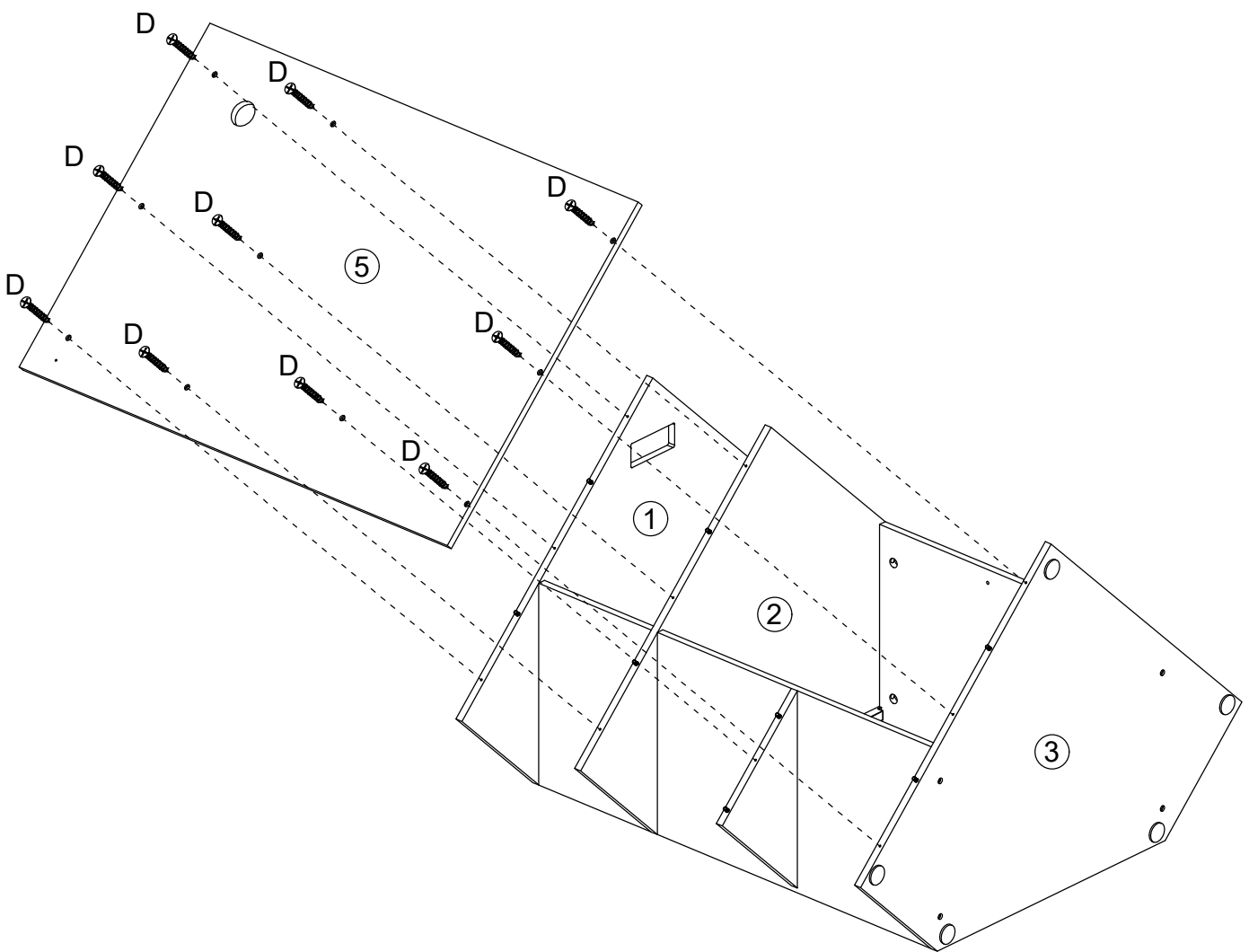
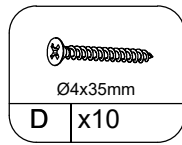
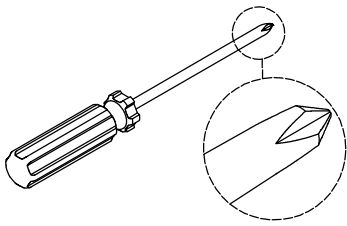

# STEP 10

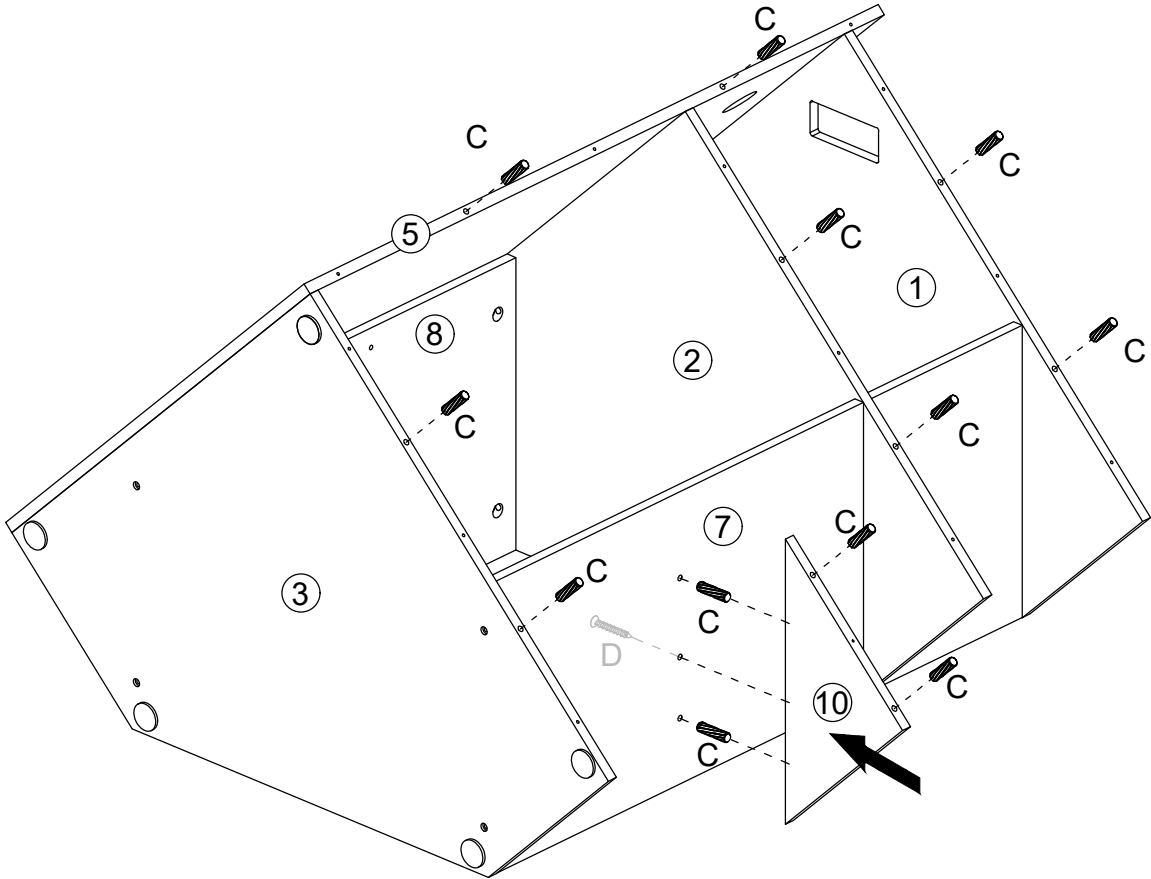
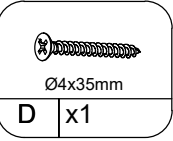
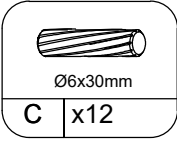
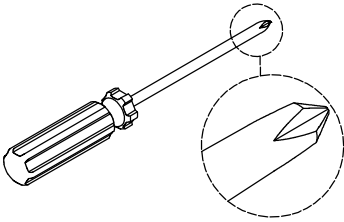

# STEP 11

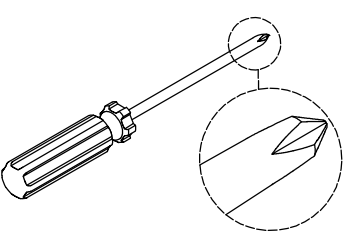

	
Ø4x35mm	
D	x13

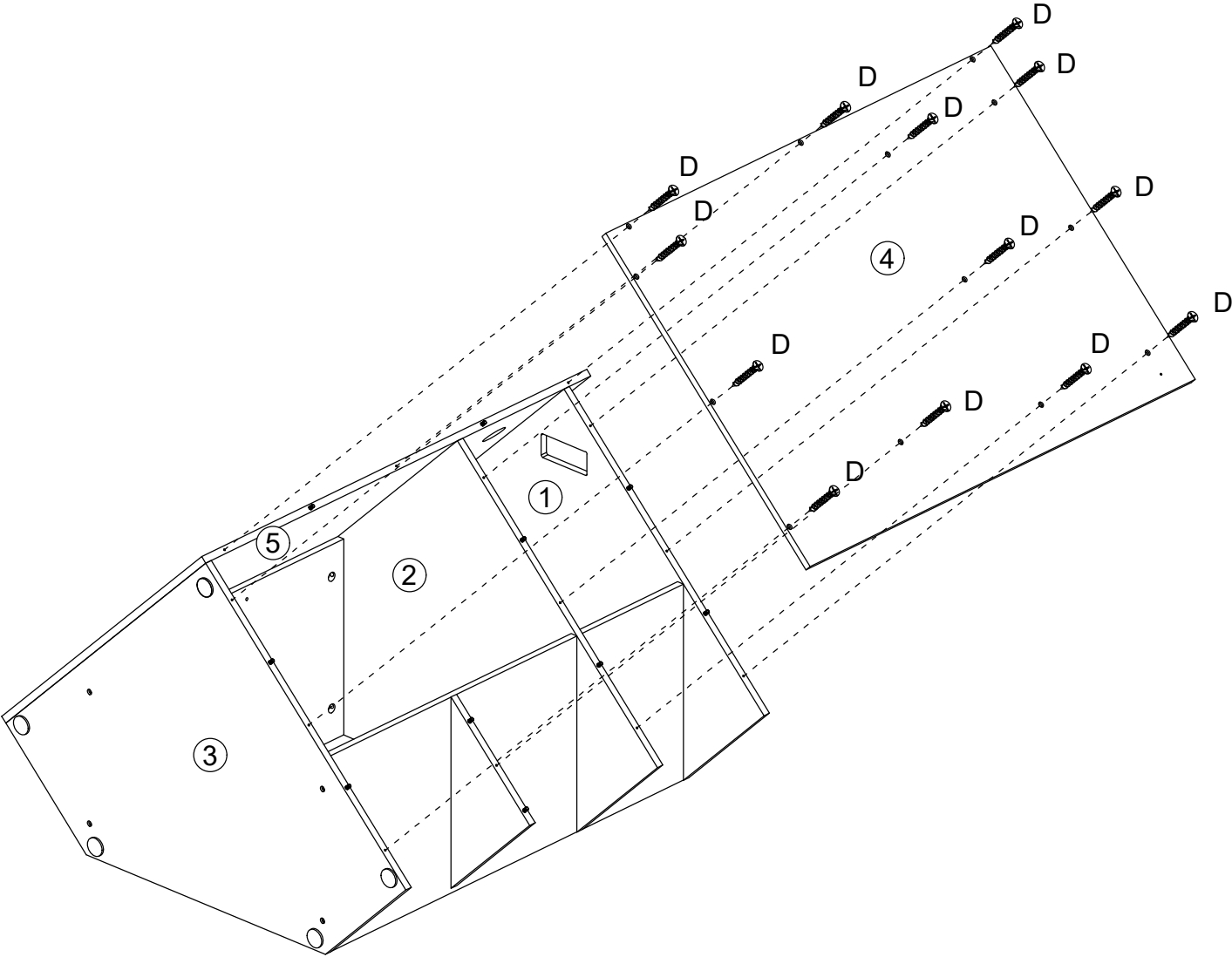

# STEP 12

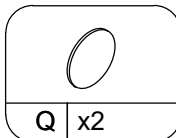
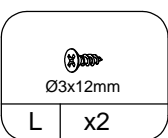
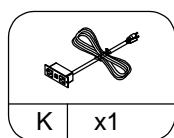
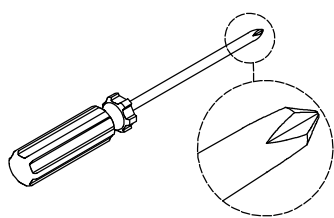

# STEP 13

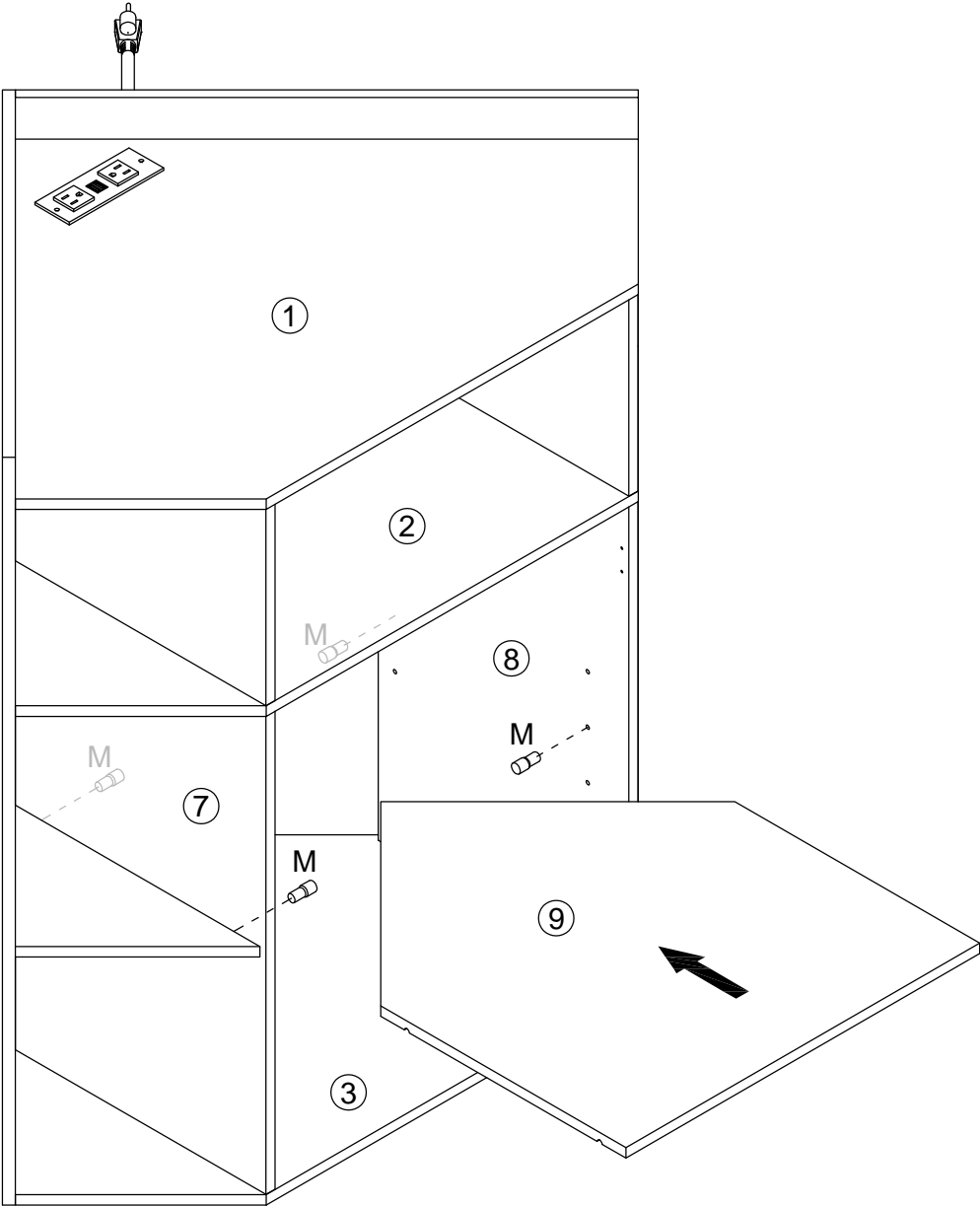
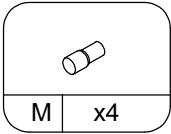

# STEP 14

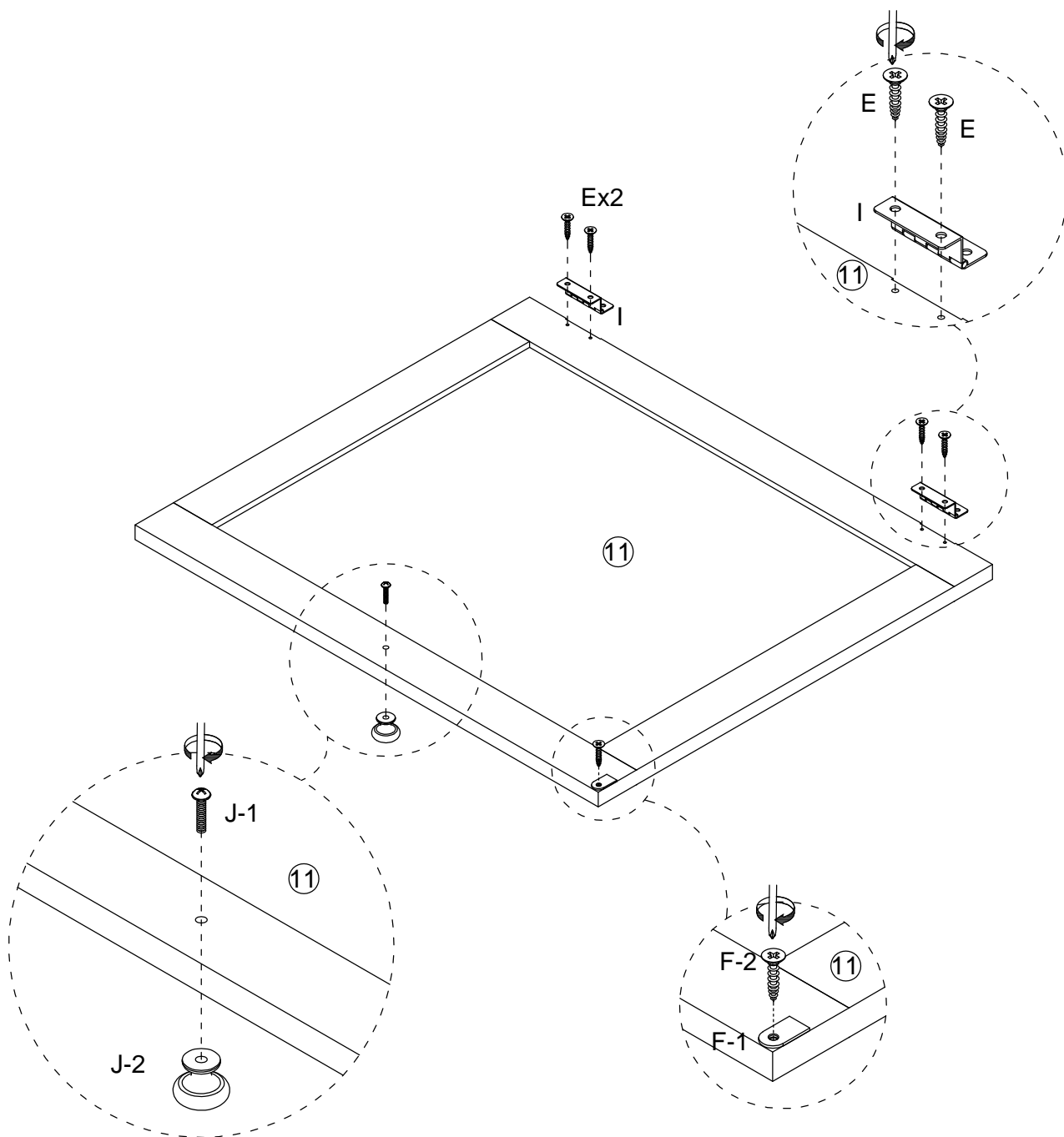
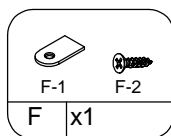
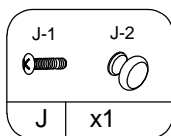
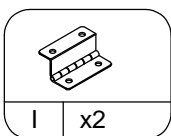
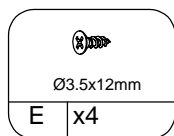
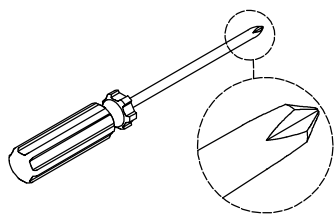

# STEP 15

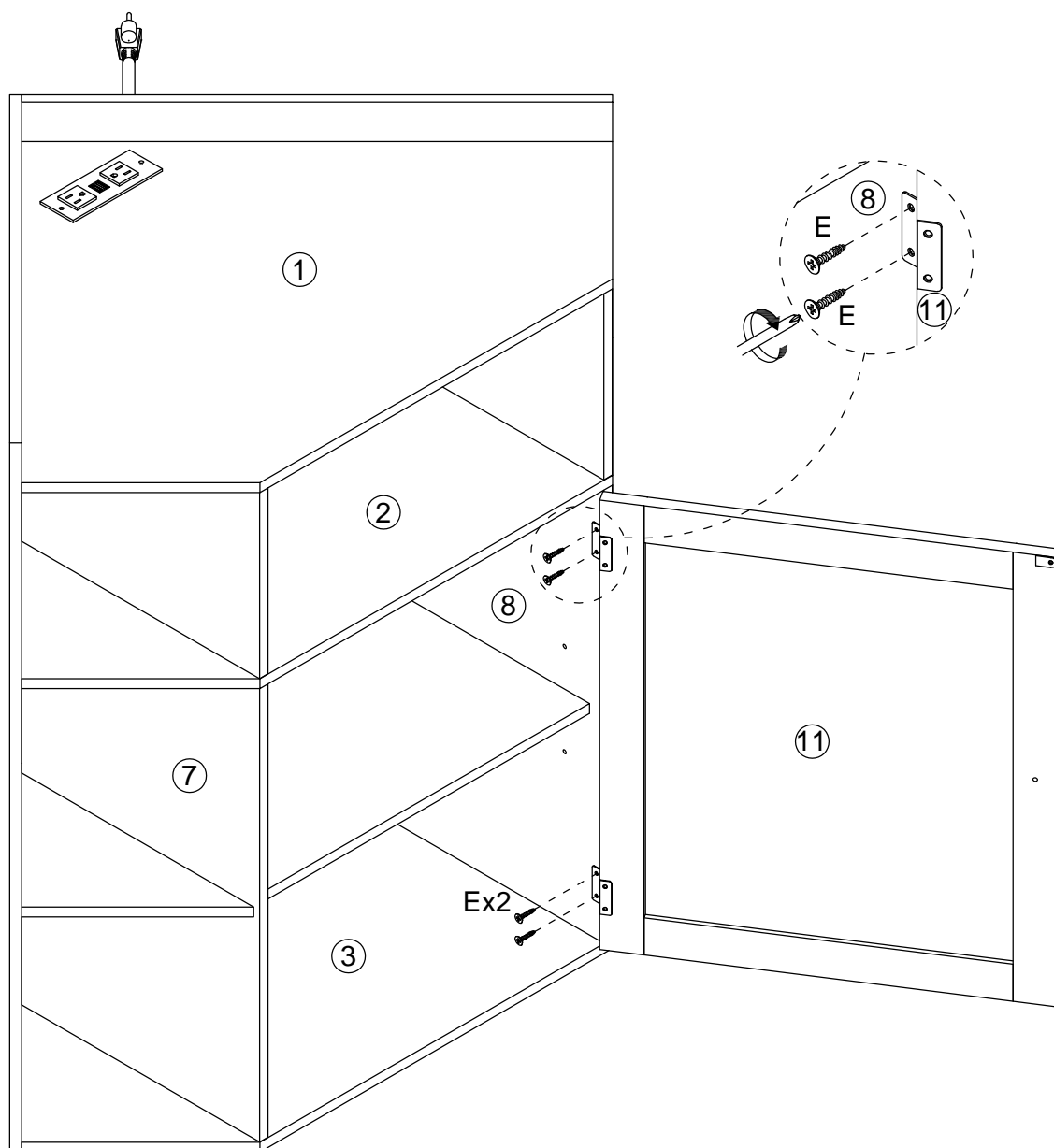
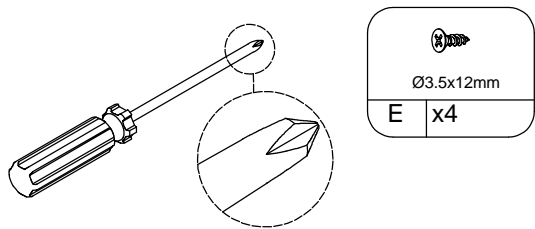

# STEP 16

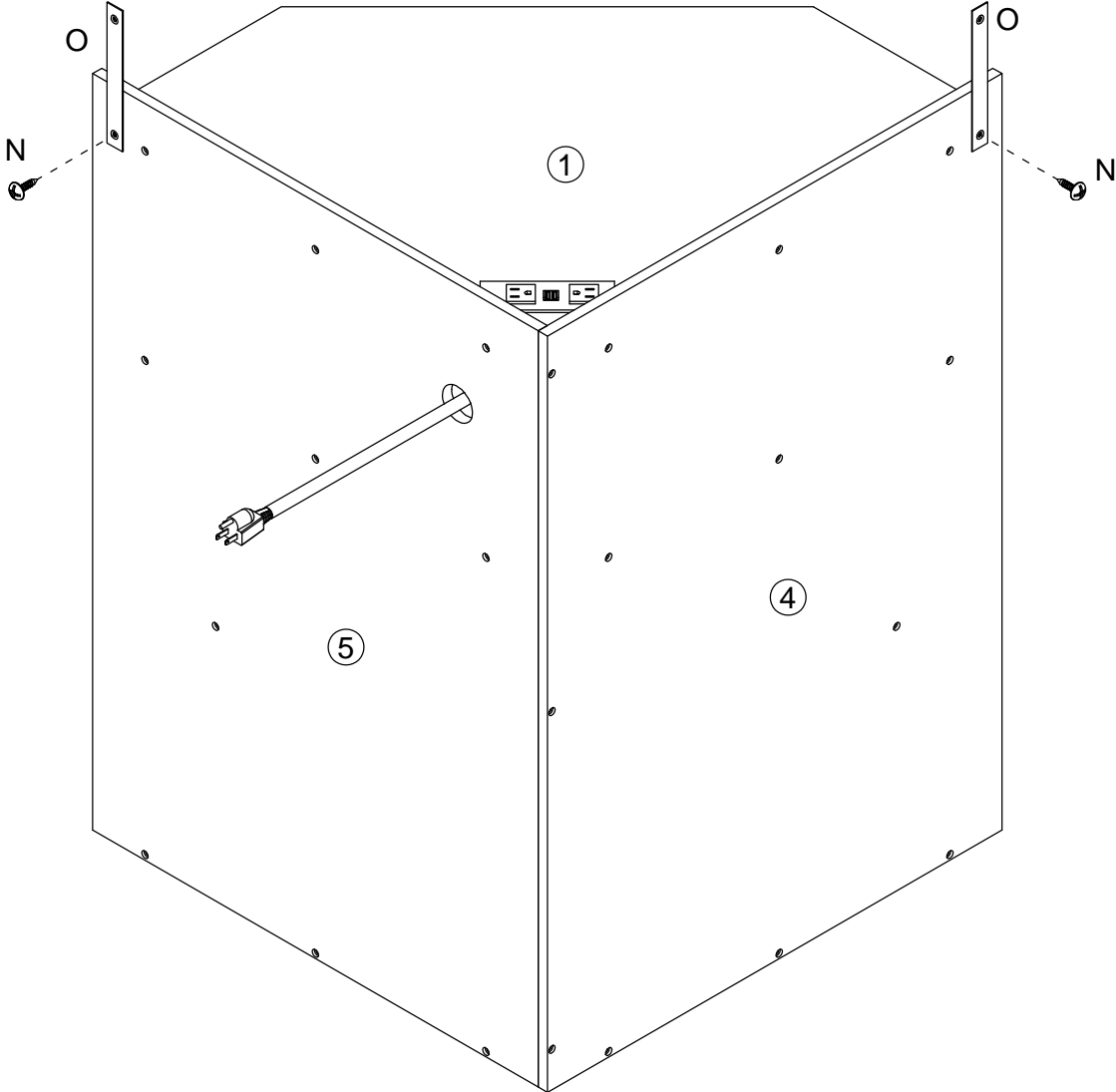
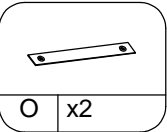
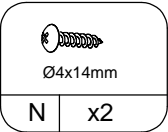
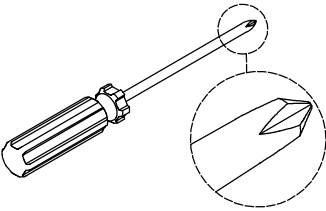

# STEP 16

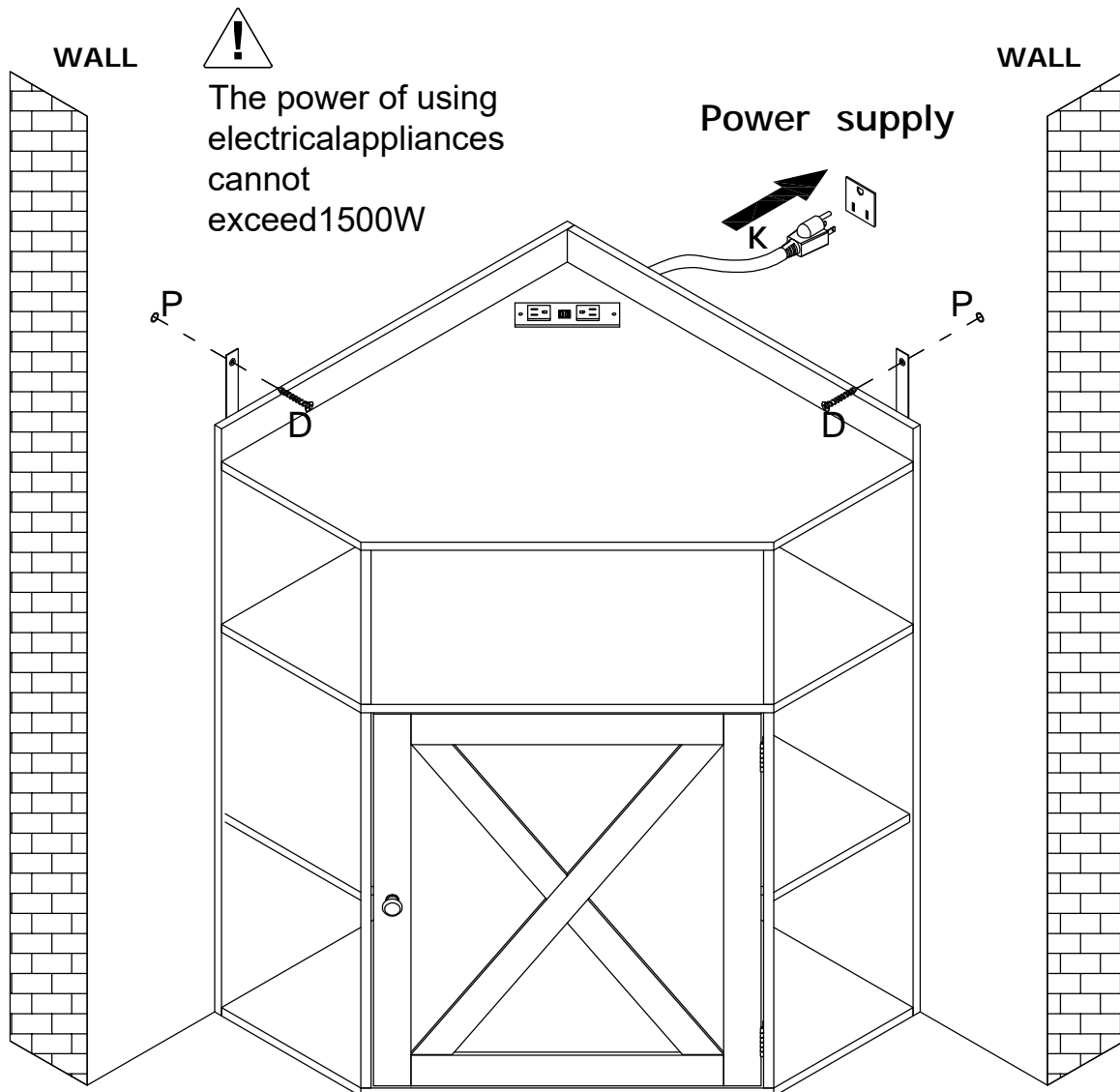
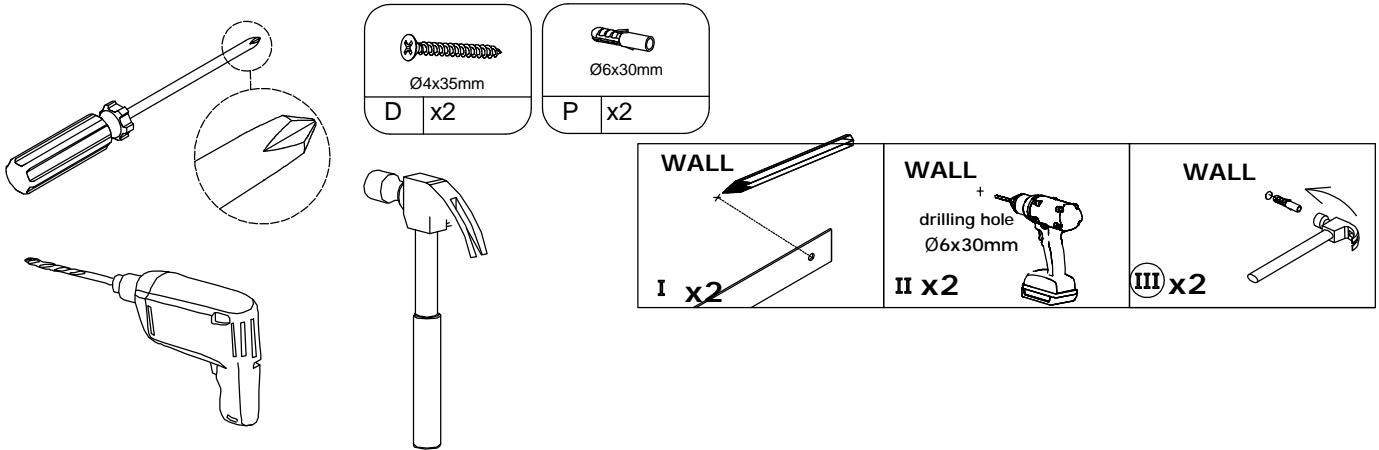

## ⚠ WARNING



Children have died from furniture tipover. To reduce the risk of furniture tipover:

- ALWAYS install tipover restraint provided.
- NEVER put a TV on this product.
- NEVER allow children to stand, climb or hang on drawers, doors, or shelves.
- NEVER open more than one drawer at a time.
- Place heaviest items in the lowest drawers.
- Do not defeat or remove the drawer interlock system.

This is a permanent label.

Do not remove!

## ⚠ ATTENTION



Des enfants sont morts du basculement des meubles. Pour réduire le risque de basculement des meubles:

- TOUJOURS installer la retenue de basculement fournie.
- NE JAMAIS mettre de téléviseur sur ce produit.
- NE JAMAIS permettre aux enfants de se tenir debout, de grimper ou de s'accrocher à des tiroirs, des portes ou des étagères.
- N'ouvrez JAMAIS plus d'un tiroir à la fois.
- Placez les objets les plus lourds dans les tiroirs les plus bas.
- Ne désactivez pas et ne retirez pas le système de verrouillage du tiroir.

Ceci est une étiquette permanente.

Ne pas enlever!

## ⚠ WARNING



Kinder sind an einem Möbelkipp gestorben. So verringern Sie das Risiko eines Umkippens von Möbeln:

- Installieren Sie IMMER die mitgelieferte Kipprückhaltevorrichtung.
- Stellen Sie NIEMALS einen Fernseher an dieses Produkt.
- Lassen Sie Kinder NIEMALS an Schubladen, Türen oder Regalen stehen klettern oder hängen.
- Öffnen Sie NIEMALS mehr als eine Schublade gleichzeitig.
- Legen Sie schwerste Gegenstände in die untersten Schubladen.
- Besiegen oder entfernen Sie das Schubladenverriegelungssystem nicht.

Dies ist ein dauerhaftes Etikett.

Nicht entfernen!