

(A) x14



(B) x2



(C) x2

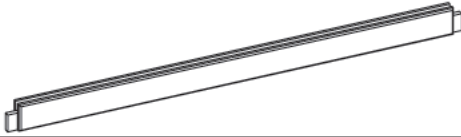

(D) x2

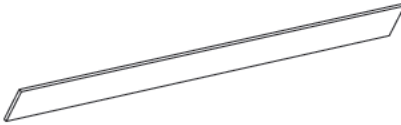

(E) x4

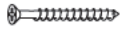

6x120
0.2x4.7

(F) x84



2.5x20
0.1x0.8

1

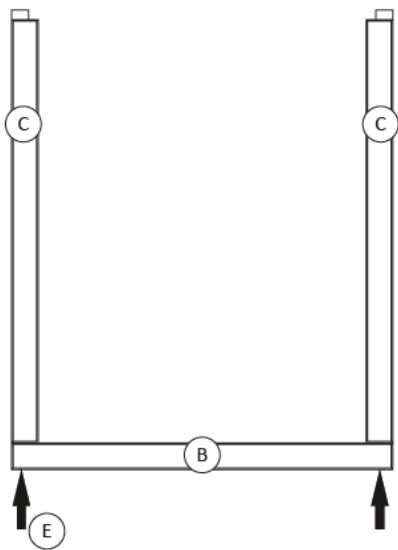

2

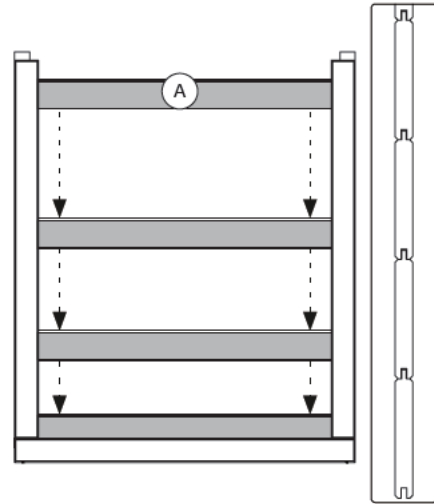

3

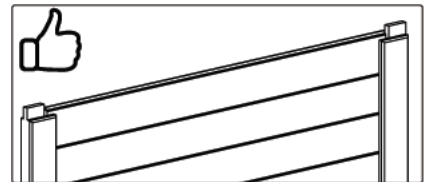
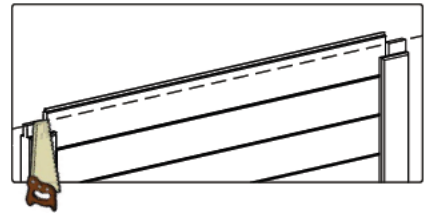

4

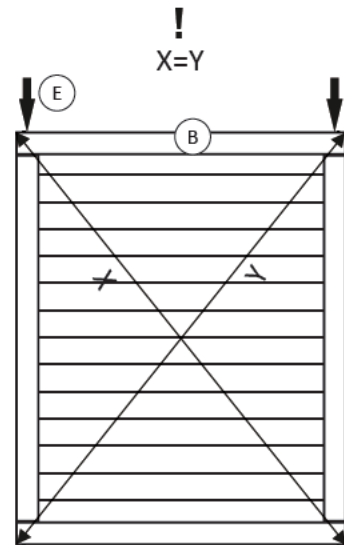

5

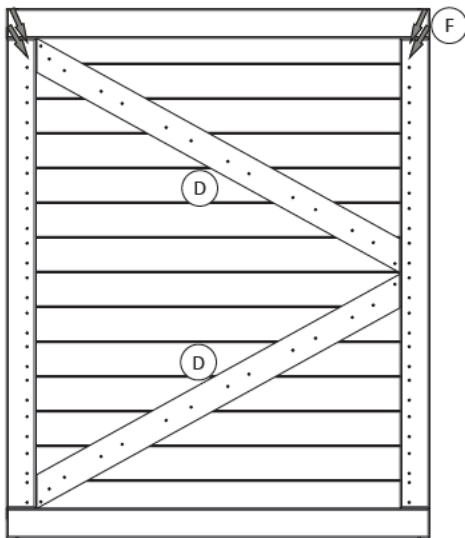

6

