

Giluta

Contact us: service@giluta.com

H0089

2Doors Wine and Bar Storage Cabinet

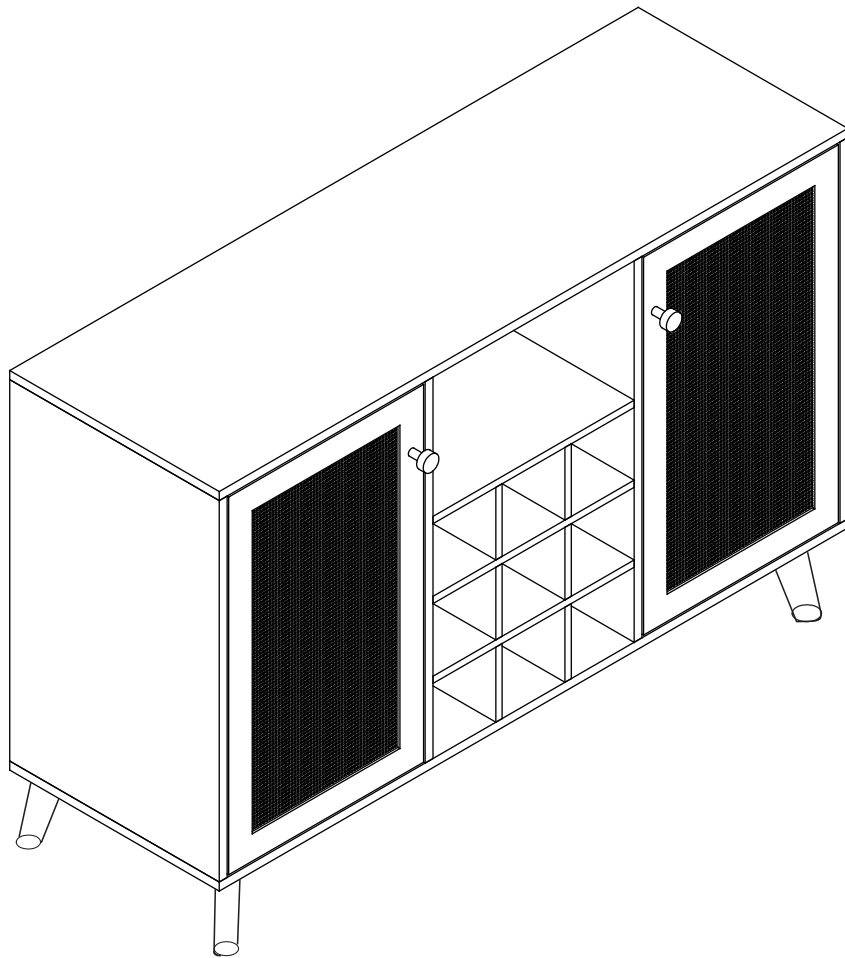

1 HOUR
ASSEMBLY TIME

2 PEOPLE
REQUIRED FOR ASSEMBLY

2 x 1 m
FLOOR SPACE REQUIRED

ASSEMBLY & INSTRUCTION MANUAL

SAFETY PRECAUTIONS

PLEASE READ ALL INSTRUCTIONS CAREFULLY BEFORE ASSEMBLING AND USING THE PRODUCT.

1. Please check that all parts are present before you start the assembly of your furniture. A **Philips head screwdriver (not included)** is required for the assembled of this product.
2. For ease and speed of assembly, we recommend that before you commence each step of the assembly, that you identify all the parts required for that step.
3. For larger items, please ensure that you have sufficient space and people to assemble your product safely.
4. We recommend that, where possible, all items are assembled near to the area in which they will be placed in use, to avoid moving the product unnecessarily once assembled.
5. For the protection of your furniture, we recommend that the product is placed on a protected surface during assembly to prevent any damage.
6. Always place the product on a flat, steady and stable surface.
7. Do not stand on the product. Do not use the product as a stepladder.
8. This product is intended for indoor, household use only as it is a non industrial product.

CARE AND CLEANING

- Please periodically check all fittings and re-tighten as necessary.
- To clean your item, please use a damp cloth and wipe clean.
- Never allow any kind of liquid to remain on your furniture. If liquid spills onto the product, please wipe clean as soon as possible.



**WARNING: ENSURE THE WALL STRAP IS ATTACHED TO
AVOID SERIOUS INJURY.**

To avoid any serious or fatal injury, this product has been fitted with a wall strap to prevent toppling. We strongly recommend that this product is permanently fixed to the wall or other suitable surface. Fixing devices are not included since different surface materials require different attachments. Please seek professional advice if you are in doubt of what fixing device to use.

Do not stand on the product. Do not climb on the product. Do not swing on the product.

READ AND SAVE THESE INSTRUCTIONS FOR FUTURE REFERENCE

ASSEMBLY DIAGRAM

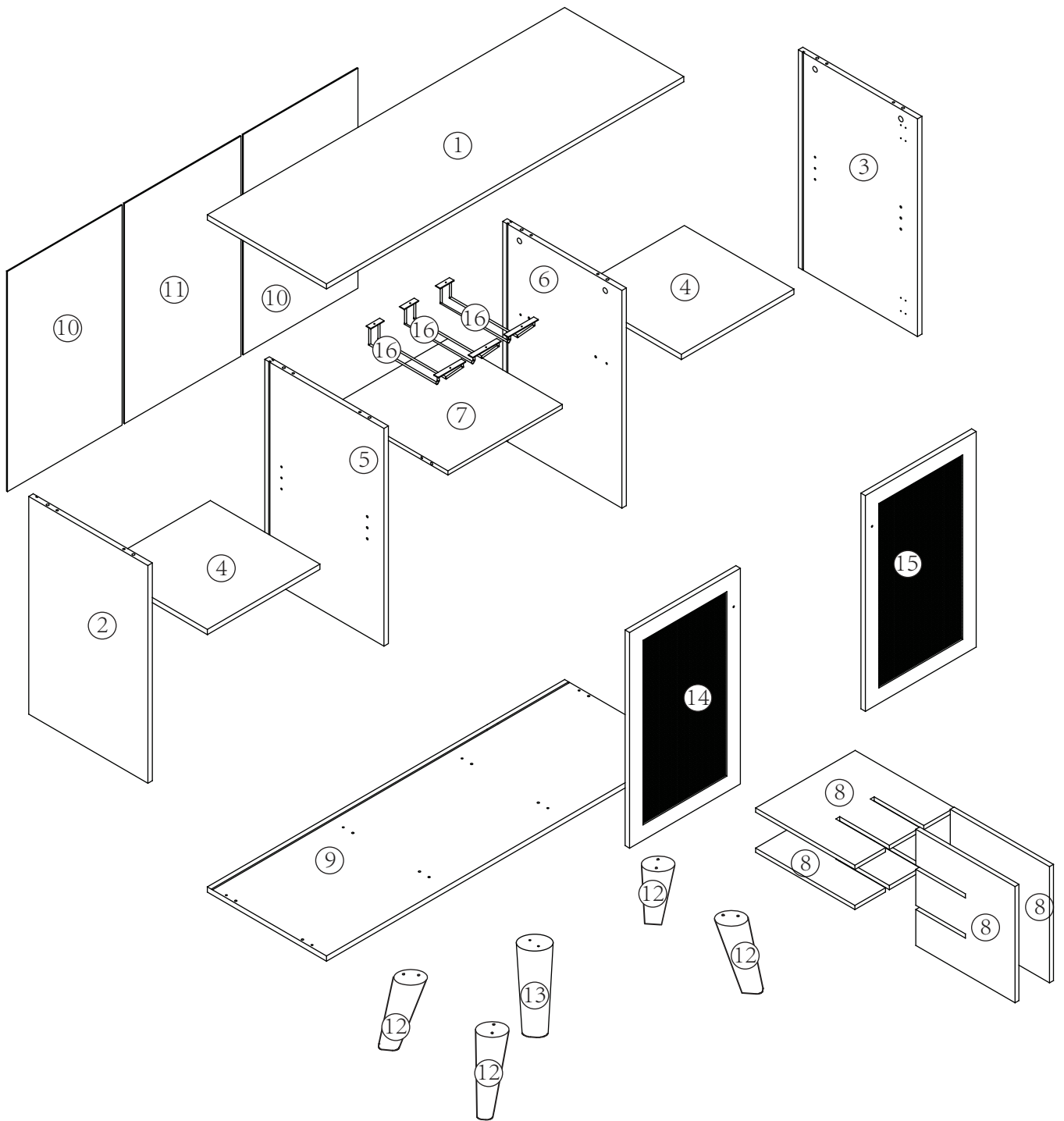











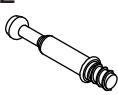

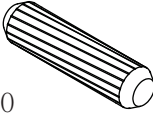
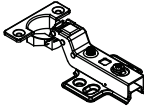

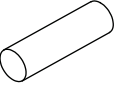
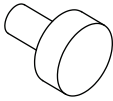
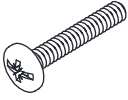
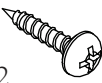
AFTER SALES SUPPORT

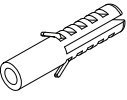
If you have any general enquiries or require spare parts for this product, please feel free to contact us via the following email:







Email: service@giluta.com

You can contact us for support at any time. We'll answer you in 24hrs.

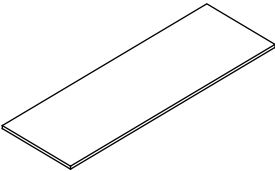
HARDWARE LIST

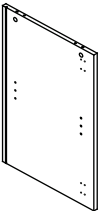
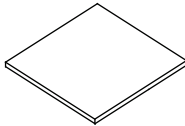
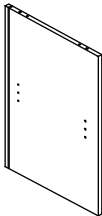
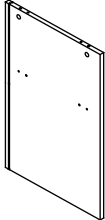
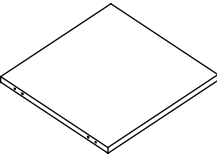
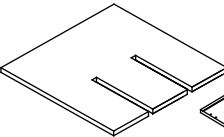
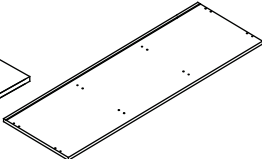
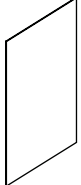
Ax12 	Bx12 	Cx18 M4x45 	Dx20 M6x30 	Ex4 
Fx24 M4x14 	Gx8 	Hx2 	Ix2 M4x20 	Jx2 M4x12 
Kx2 	Lx2 	Mx5 	Nx2 M4x35 	Ox12  
Px20 M6x12 	Qx4 	Rx6 M3x12 	Sx1 	

PARTS LIST

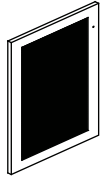
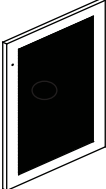
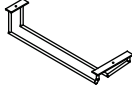
					
1-1 PC	2-1 PC	3-1 PC	4-2 PCS	5-1 PC	6-1 PC
					
7-1 PC	8-4 PCS	9-1 PC	10-2 PCS	11-1 PC	
					
12-4 PC	13-1 PCS	14-1 PC	15-1 PC	16-3 PCS	

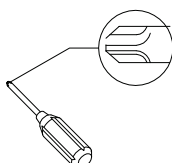

Philips head screwdriver required for assembly
(not included)

The hardware quantities listed above are required for proper assembly.
Some extra hardware may also have been included.

TIPS Before ASSEMBLY

IMPORTANT

1. Do not tighten bolts completely until all bolts are lined up and inserted into holes.
1. Do not over tighten screws and bolts to avoid stripping.

what you need

- Some of your favourite fruits or your preferred snacks.
- Use the packaging carton as a working surface to prevent possible product damage during assembly.

Safety First, Fun Later

We want your Furniture Unit to last as long as possible, so we recommend that you tighten the screws 2 weeks after assembly, and for added safety, check the tightness of all screws every 2 months.

We do our best to ensure your Furniture arrives without any problems, but occasionally mistakes happen - as humans we are imperfect beings. In the event that a part is damaged or missing, we will be more than happy to provide you with replacement part(s) for free.

For more help, you can send a message to our customer support email service@gilura.com in any time.

Ready? OK, let's get rolling!

This should be very easy, just follow our simple instructions step by step and you will put it together in no time.

ASSEMBLY STEPS

STEP 1.

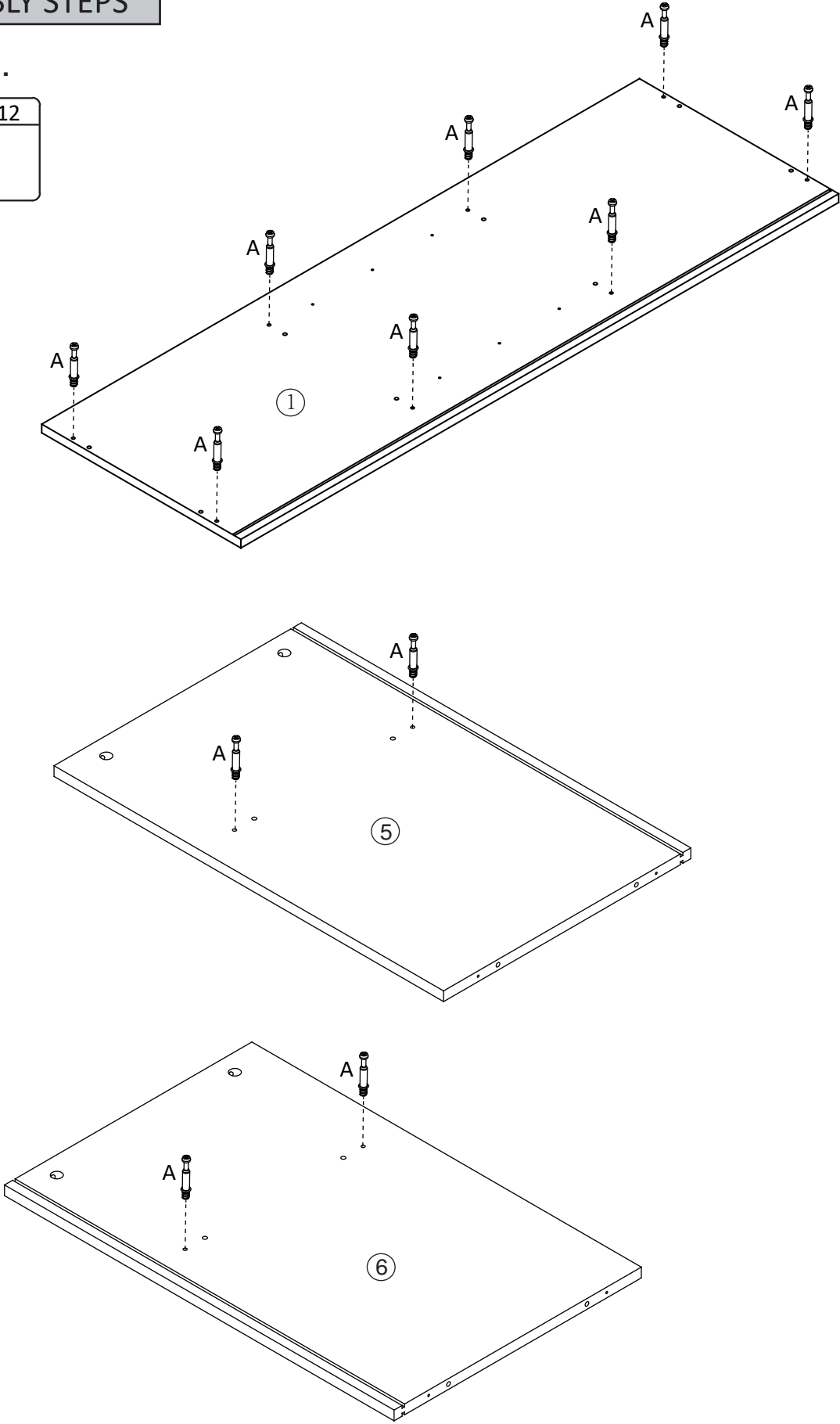
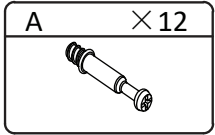

ASSEMBLY STEPS

STEP 2.

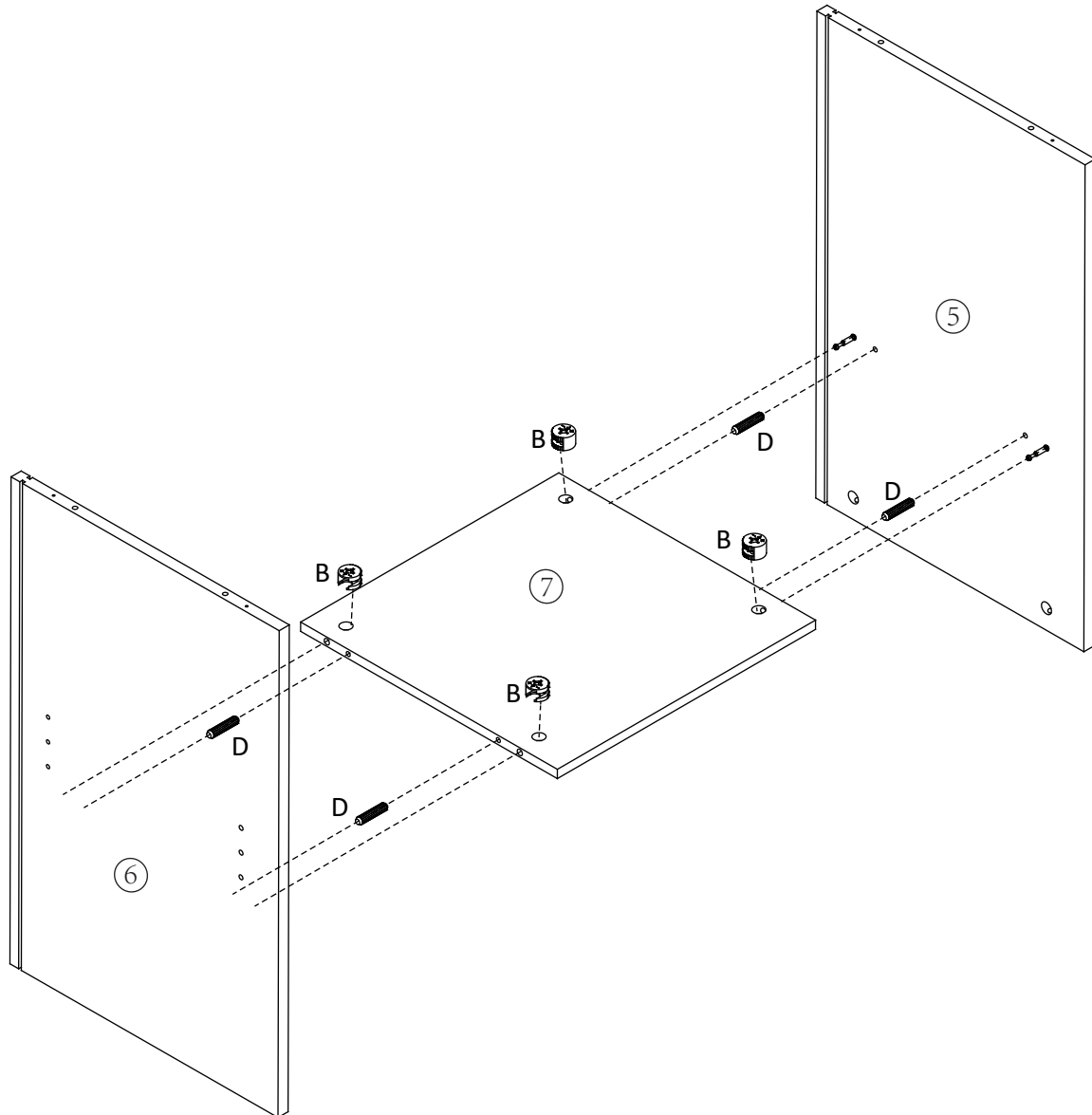
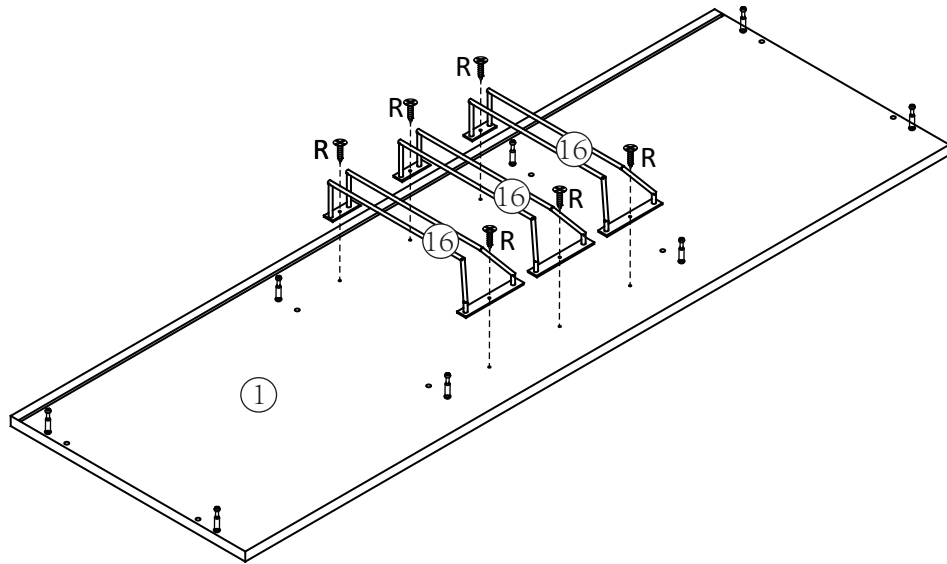
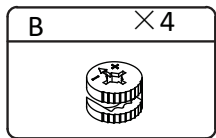
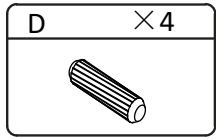
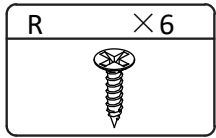

ASSEMBLY STEPS

STEP 3.

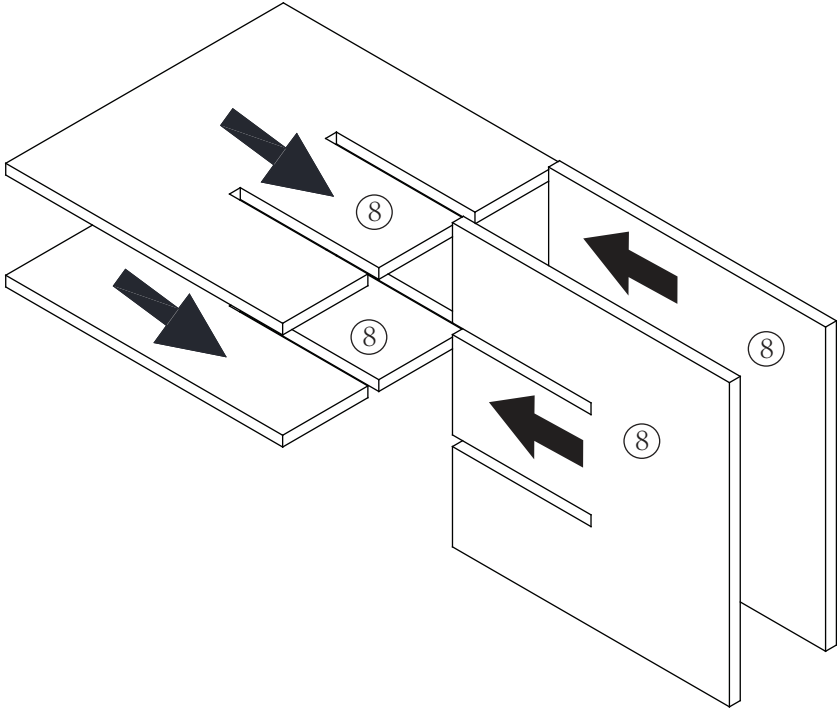

STEP 4.

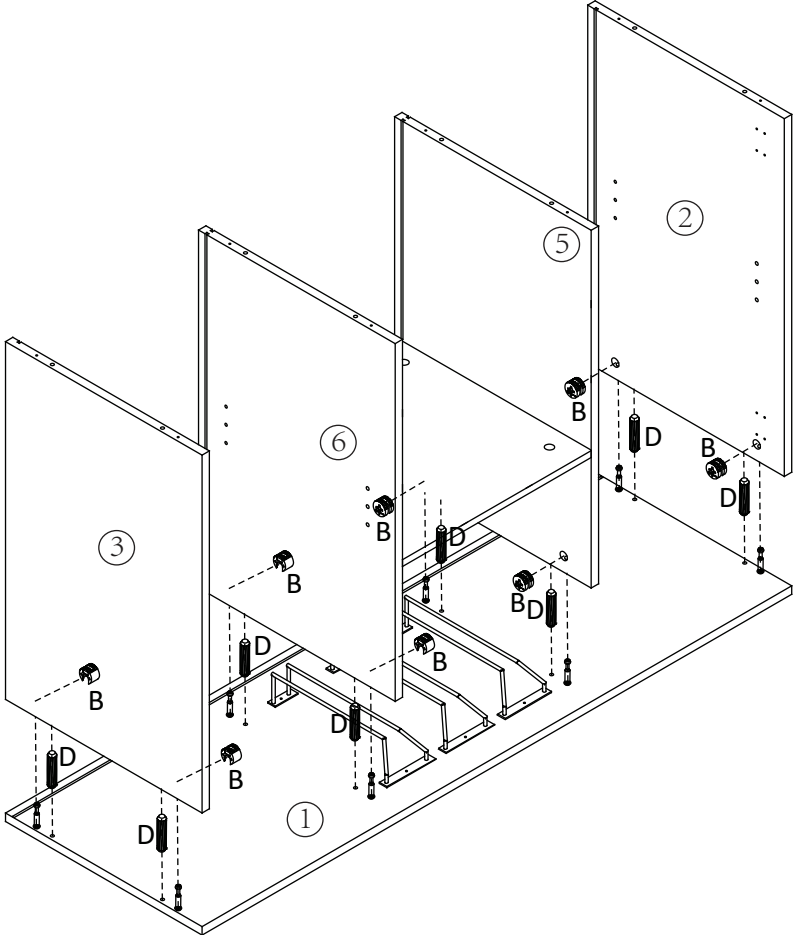
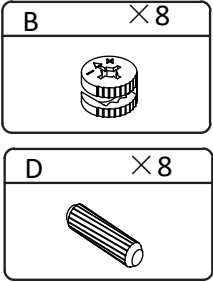

ASSEMBLY STEPS

STEP 5.

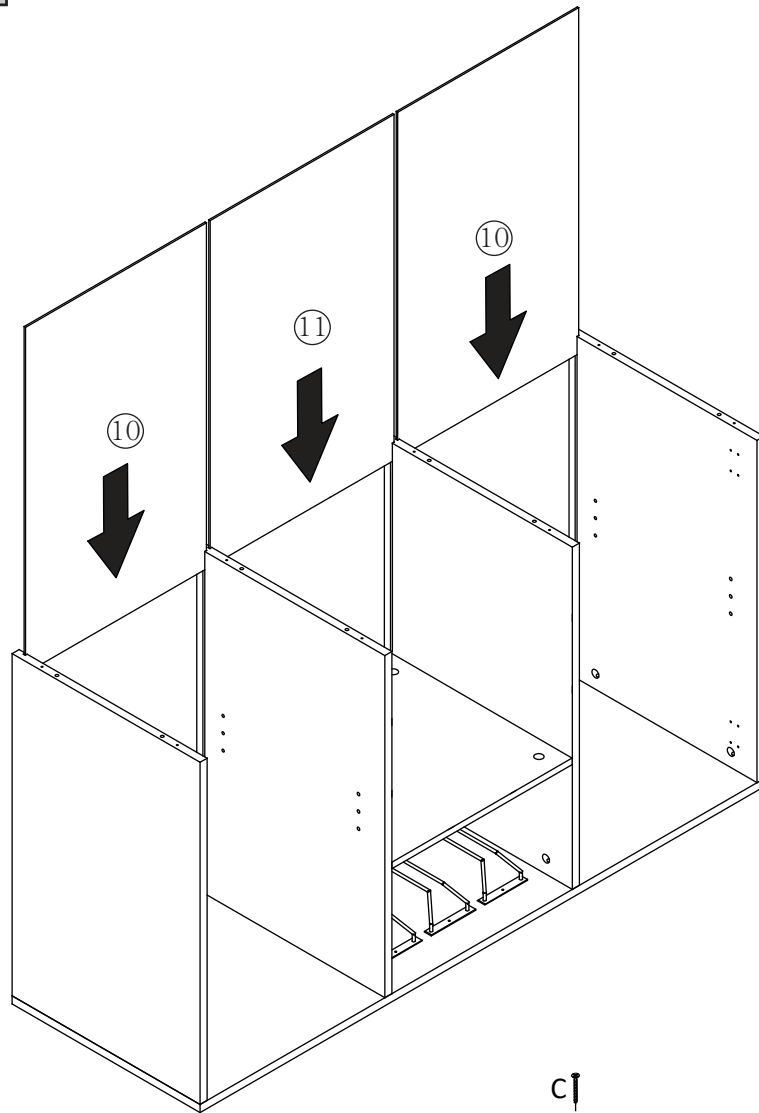

STEP 6.

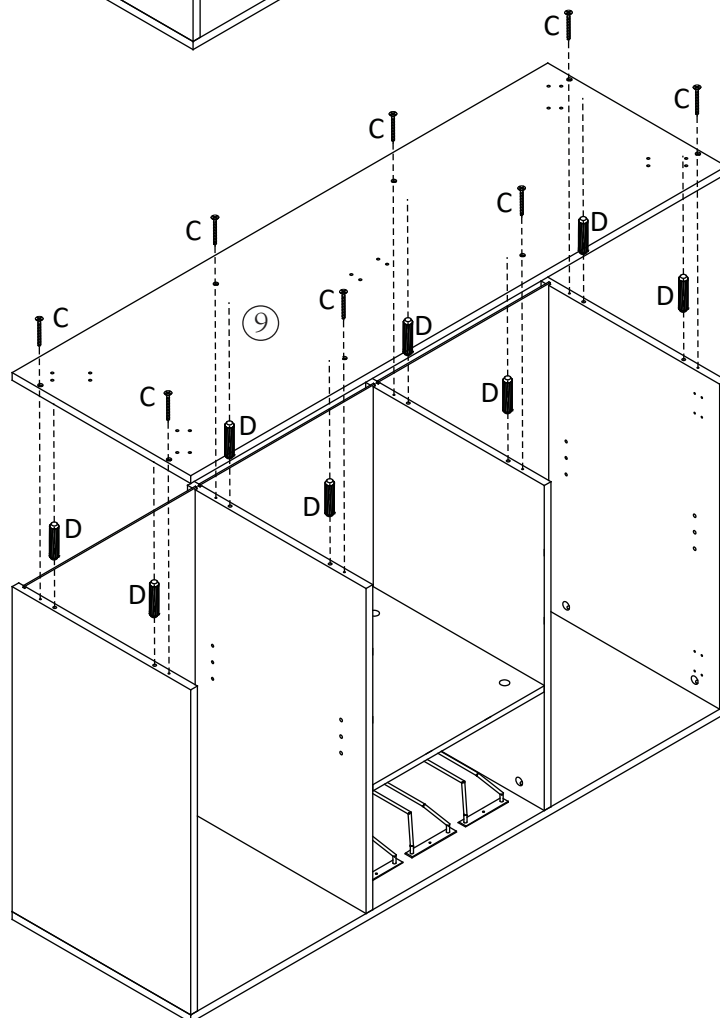
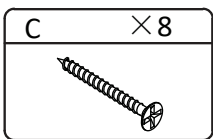
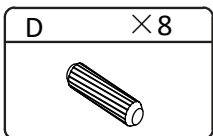

ASSEMBLY STEPS

STEP 7.

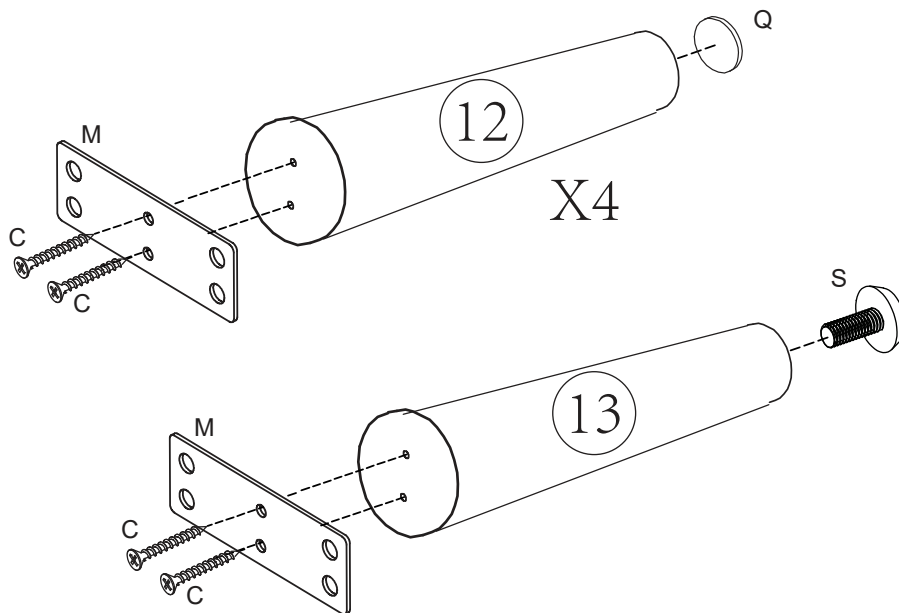
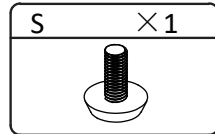
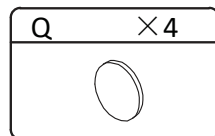
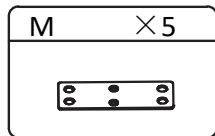
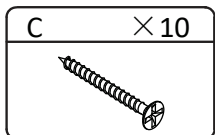

STEP 8.

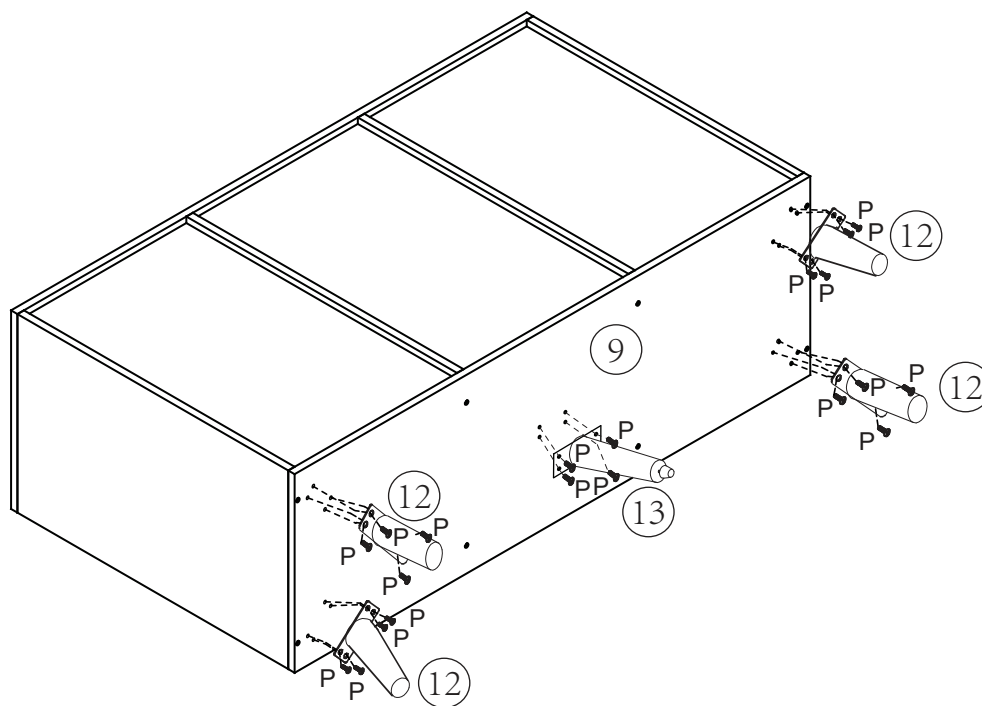
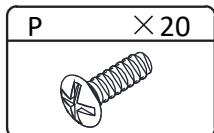

ASSEMBLY STEPS

STEP 9.

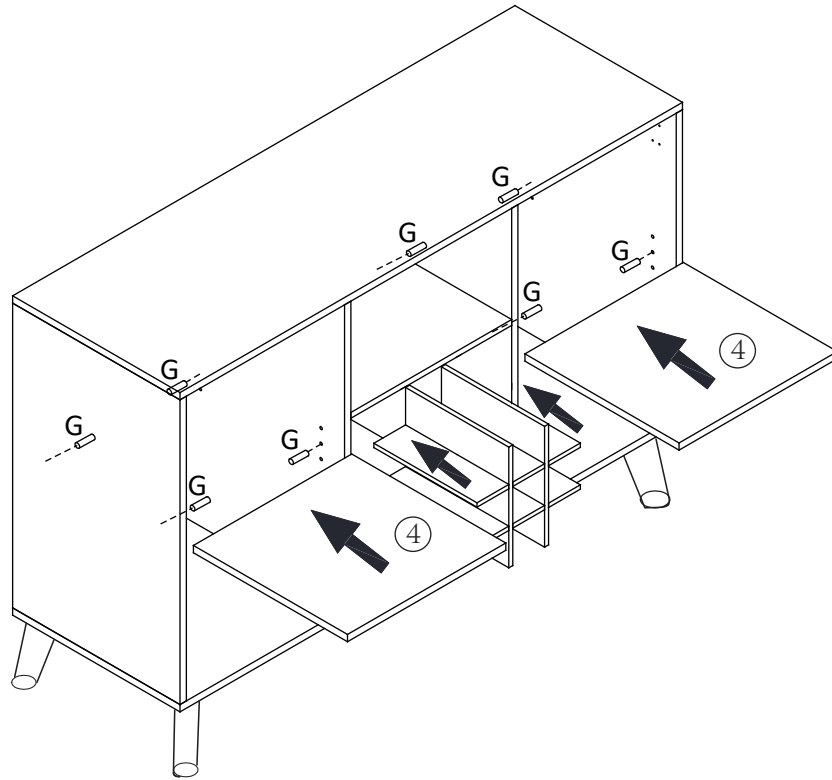
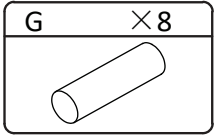

STEP 10.

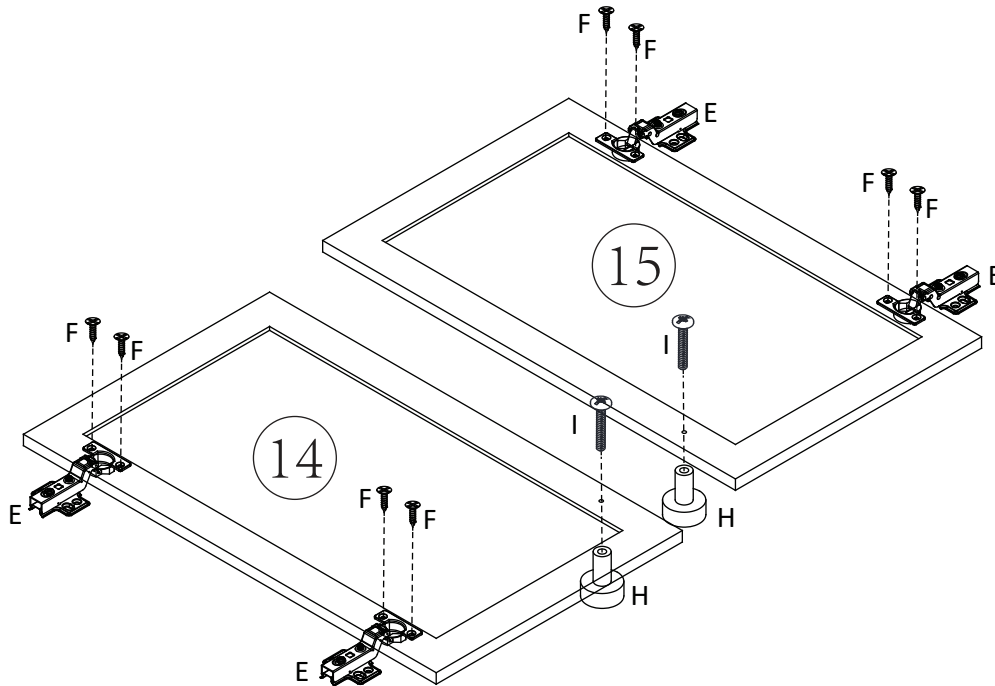
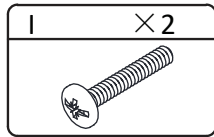
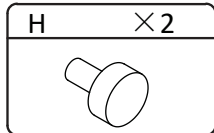
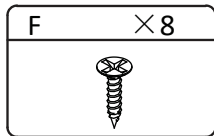
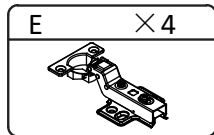

ASSEMBLY STEPS

STEP 11.

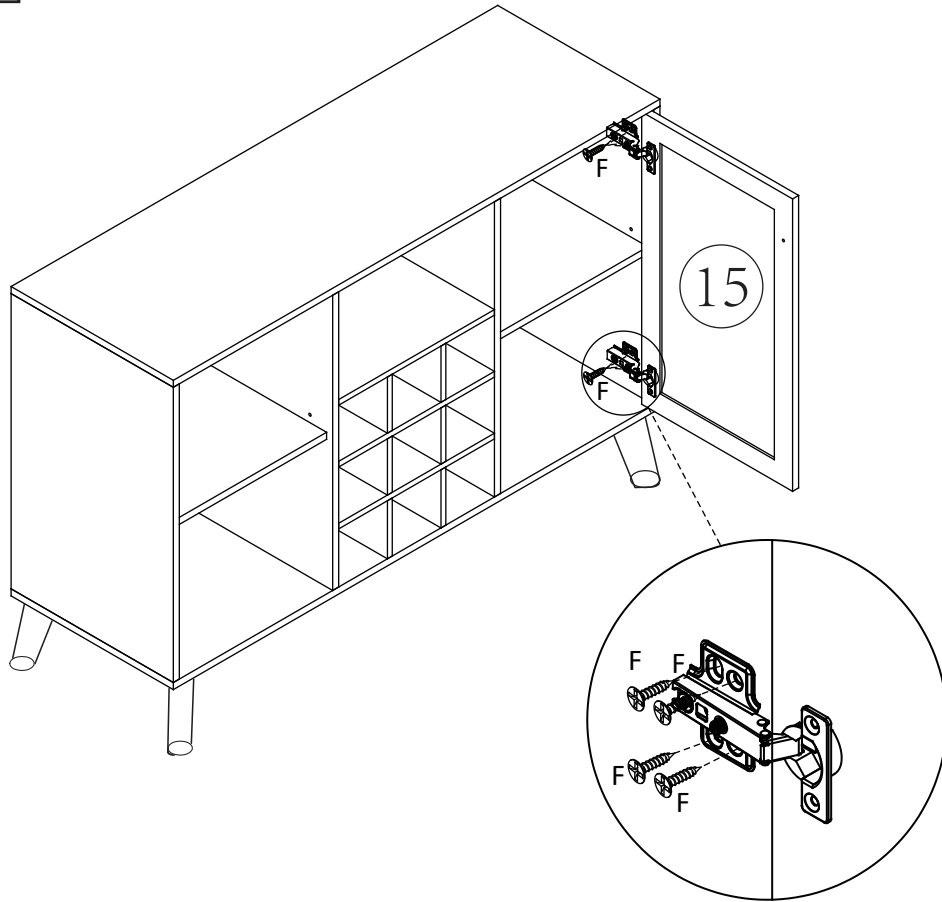
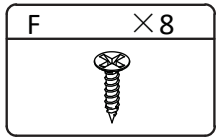

STEP 12.

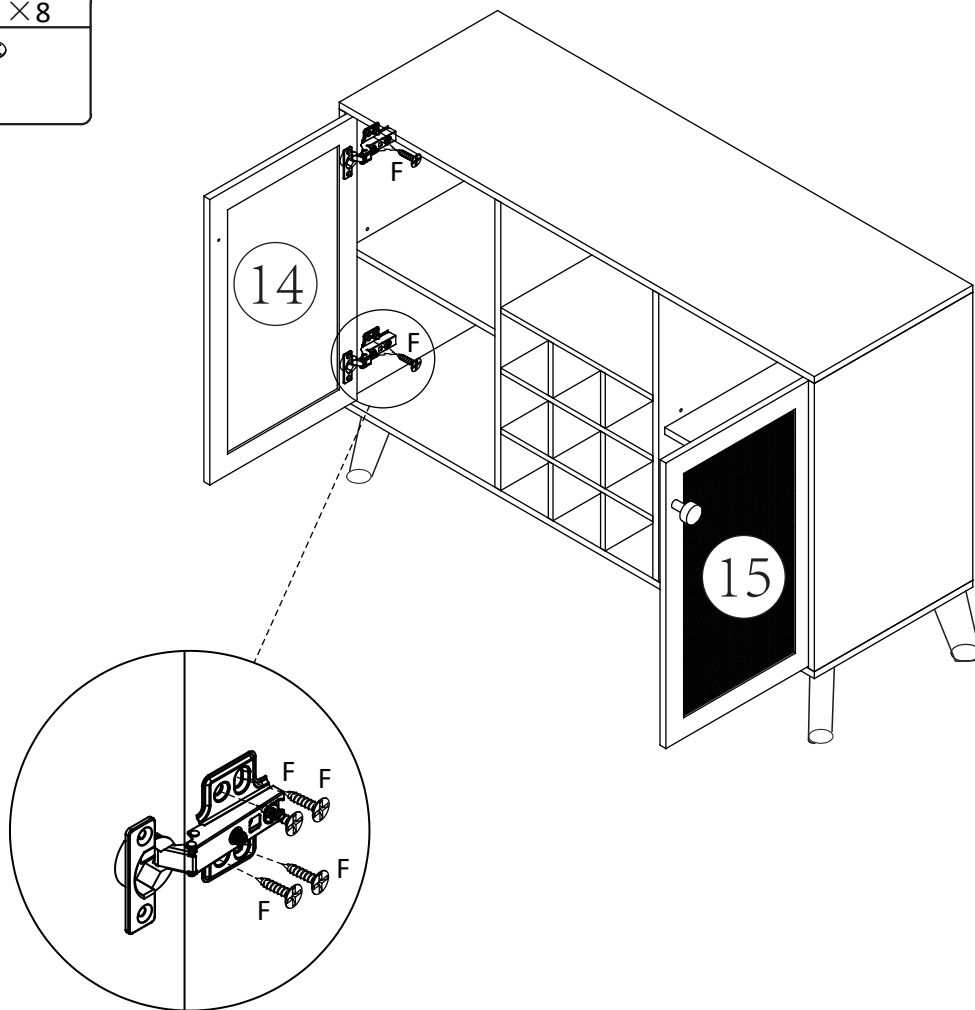
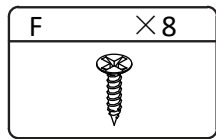

Is your cabinet door looking crooked or unevenly spaced?

Then you've come to the right place. Follow the illustrations below to get your cabinet door aligned and ready for action.

If your door is too low or too high...

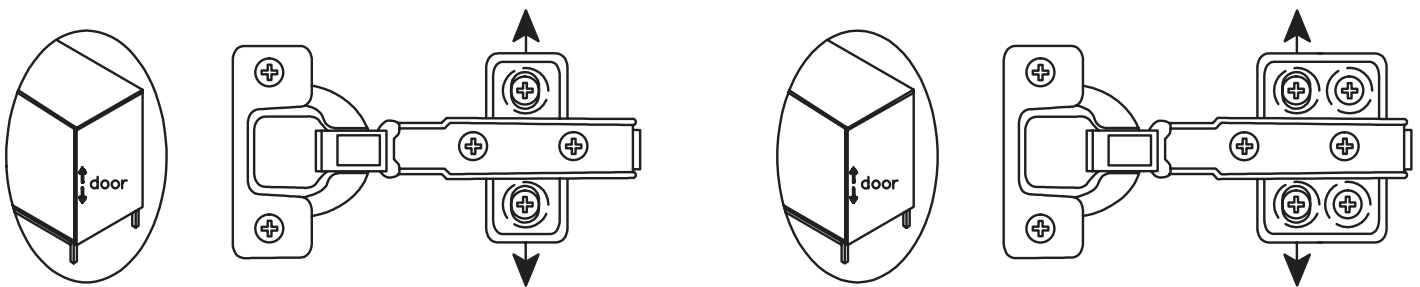

Loosen the height screws, then move the door up or down to make it level.

If the space between your doors is off...

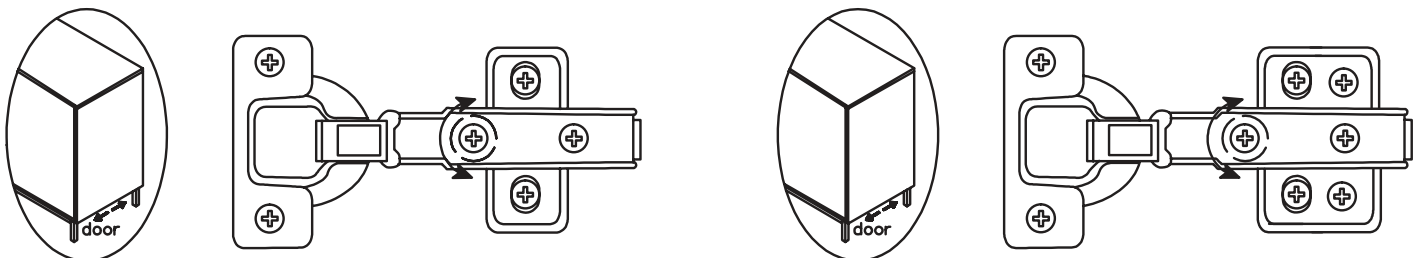

Loosen the side-to-side screws, then screw counter-clockwise to make the gap wider or clockwise to close any gaps.

If you need to adjust the depth of the doors...

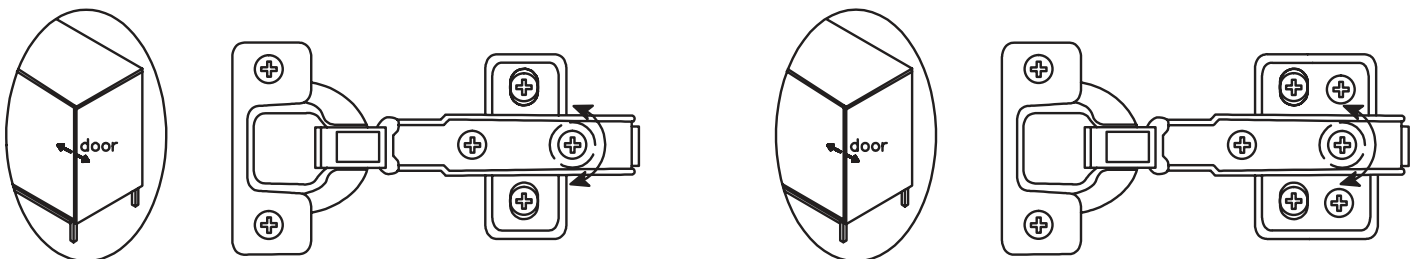

Adjust the in-and-out screws until the door is aligned with the side of the cabinet.

ASSEMBLY STEPS

STEP 13.



Kindly note: This is a very important step that can not be skipped. Please follow the step to screw the white pieces into the corner of the back panel tightly. If you forget to fix these pieces, it will result in the instability of the whole cabinet.

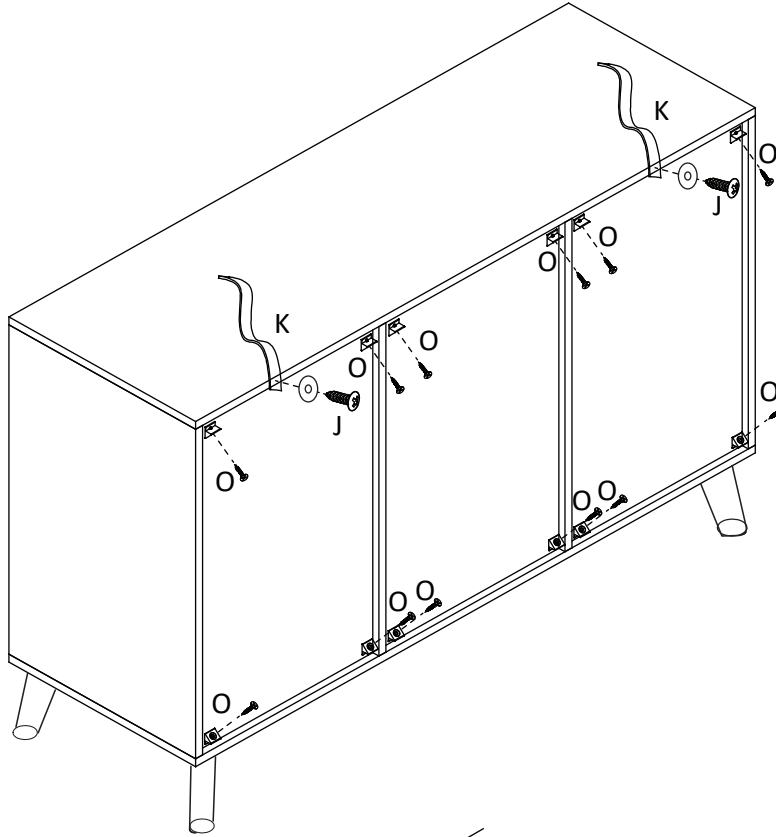
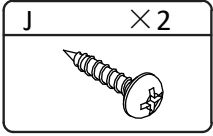
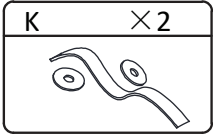
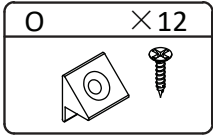

STEP 14.

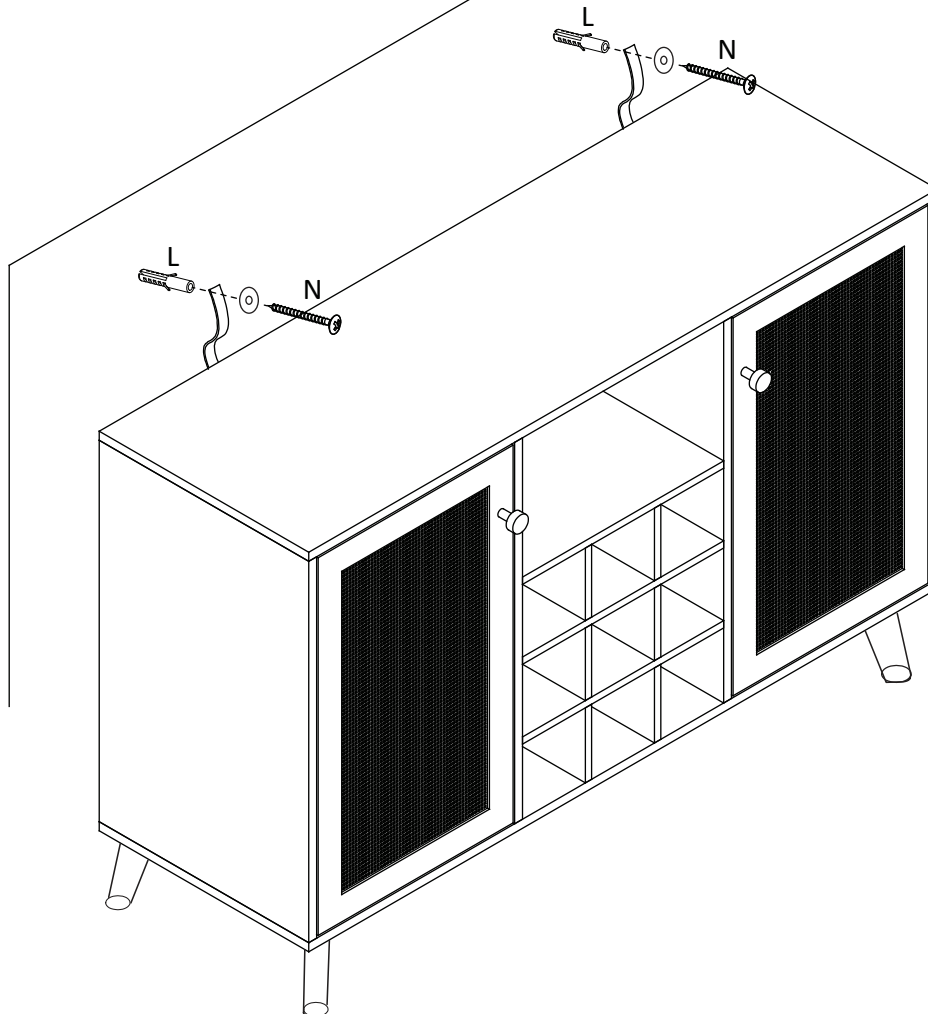
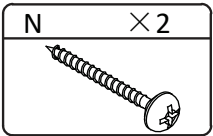
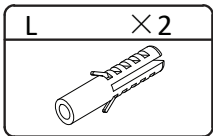

WALL FIXING GUIDE

NOTE: Supplied wall plugs are only suitable for use in masonry walls.

If you have any doubts about using the correct plug for your wall, please seek professional advice. Failure of the product due to using incorrect fixings is the responsibility of the installer.



IMPORTANT:

When drilling into walls, always check for hidden wires or pipes, etc.



Tips & Tricks

Make sure that the hardware used is suitable for supporting your unit.

Please consult a qualified trades person if unsure.

- If you are unsure, please select a larger screw and wall plug.
- Ensure that you use the recommended drill bit to match the wall plug and hole size.
- Take extra care when drilling high walls, ceiling and ceramic tiles. Ensure wall plugs are inserted beyond the thickness of the ceramic tiles to avoid splitting or cracking.
- Ensure that wall plugs are well fitted and are a tight fit in the drilled hole.

Types of Walls

Use one of the following types of wall plug (not included) if your walls are made of brick, breeze block, concrete, stone or wood. Screws may be able to be fixed directly to solid wood walls as they will provide a secure anchor point.

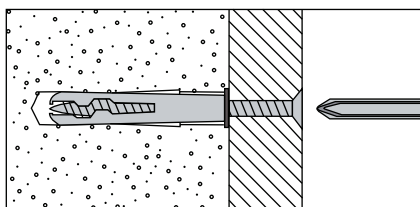

1. General Purpose Wall Plug

Generally, aerated blocks should not be used to support heavy loads, use a specialist fitting in this case. For light loads, general purpose wall plugs can be used.

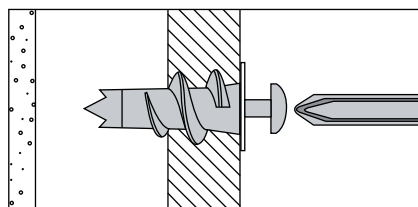

2. Plasterboard Wall Plug

For use when attaching light loads onto plasterboard partitions.

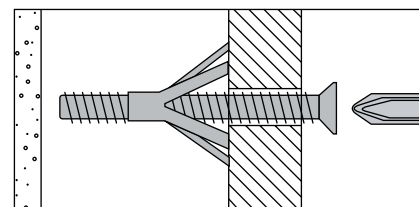

3. Cavity Fixing Wall Plug

For use with plasterboard partitions or hollow wooden doors.

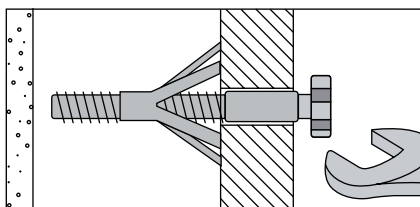

4. Cavity Fixing Heavy Duty Wall Plug

For use when fitting or supporting heavy loads such as shelving and wall cabinets.

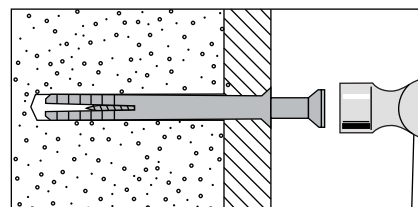

5. Hammer Fixing Wall Plug

For use with concrete block or brick walls, or walls stuck with plasterboard. The hammer fixing allows it to be fixed to the wall rather than the plasterboard. Always check the fixing is secure to the retaining wall.

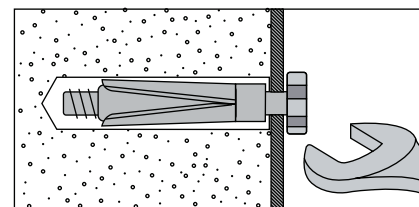

6. Shield Anchor Wall Plug Heavy Loads

For use with concrete or brick walls, or for use with heavier loads such as TV & HiFi speakers and satellite dishes, etc.