



**INSTRUCTIONS D'ASSEMBLAGE
ASSEMBLY INSTRUCTIONS**

**CHAISE -
2PCS / 39"H / TISSU TAUPE / METAL NOIR**

**DINING CHAIR -
2PCS / 39"H / TAUPE FABRIC / BLACK METAL**





**POUR DE L'ASSISTANCE OU POUR COMMANDER
DES PIÈCES CONTACTEZ NOTRE DÉPARTEMENT
DE SERVICE À LA CLIENTÈLE.**

**FOR ASSISTANCE OR TO ORDER PARTS
CONTACT OUR CUSTOMER SERVICE DEPARTMENT**

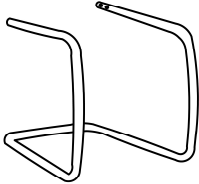

LISTE DES PIÈCES
PARTS LIST

PIÈCE / PART #	IMAGE	DESCRIPTION	QTY / QTÉ
1		BACK DOSSIER	2
2		CHAIR LEG PATTE DE CHAISE	2
3		SEAT CUSHION COUSSIN DU SIÈGE	2

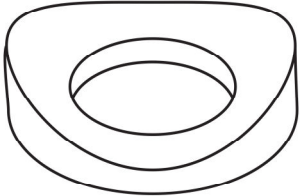
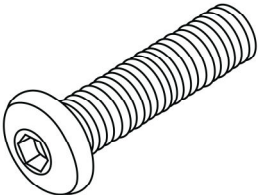
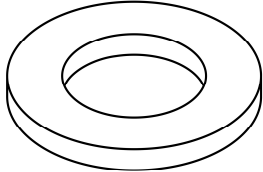
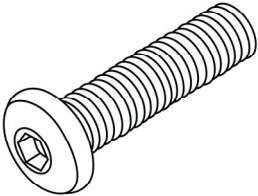
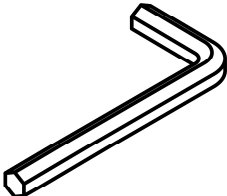

LISTE DES PIÈCES DE MONTAGE HARDWARE LIST

PIÈCE / PART #	IMAGE	DESCRIPTION	QTY / QTÉ
A		CURVED WASHER - Ø7/8" RONDELLE CURVÉE - Ø7/8"	8
B		ASSEMBLING BOLT - Ø 3/8" X 3/4" BOULON D'ASSEMBLAGE - Ø 3/8" X 3/4"	8
C		METAL WASHER - Ø 3/4" RONDELLE DE MÉTAL - Ø 3/4"	8
D		ASSEMBLING BOLT - Ø 1/4" X 3/4" BOULON D'ASSEMBLAGE - Ø 1/4" X 3/4"	8
E		HEX KEY CLÉ HEXAGONALE	2



OUTIL DE VÉRIFICATION DE DIMENSIONS DES PIÈCES
HARDWARE DIMENSIONS VERIFICATION TOOL



ÉTAPE / STEP 1

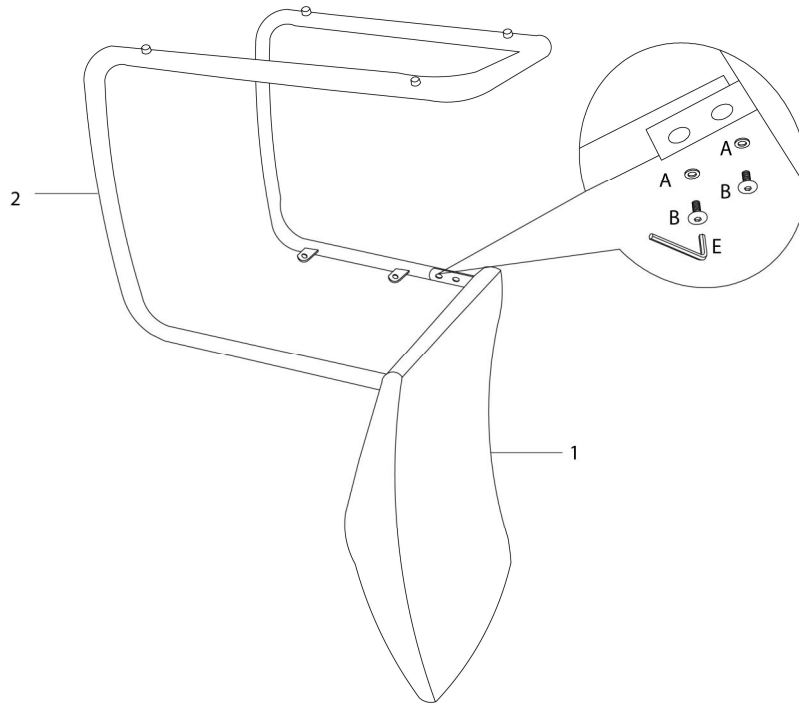

ÉTAPE / STEP 2

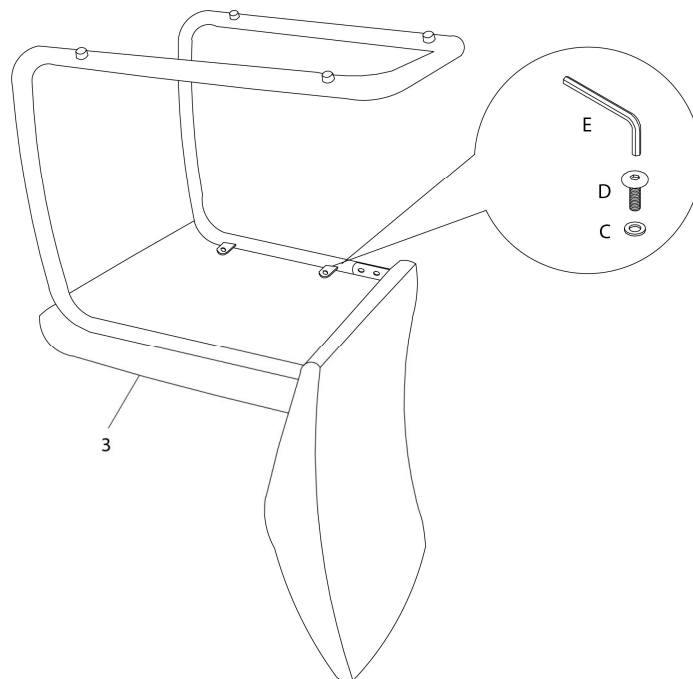

ÉTAPE / STEP 3

