

CONTENT

INTRODUCTION 2-4

SAFETY PRECAUTION..... 2-3

INSTALLATION INSTRUCTIONS..... 4

AIR OUTLET INSTALLATION METHOD..... 5

WALL MOUNTING INSTALLATION..... 5-6

OPERATION..... 7

MAINTENANCE..... 7-8

TROUBLESHOOTING..... 9

ENVIRONMENTAL PROTECTION..... 9

INTRODUCTION

INTRODUCTION

Thank you for choosing this cooker hood.

This instruction manual is designed to provide you with all required instructions related to the installation, use and maintenance of the appliance.

In order to operate the unit correctly and safely, please read this instruction manual carefully before installation and usage.

SAFETY PRECAUTION

- *Never let the children operate the machine.*
- *The cooker hood is for home use only, not suitable for barbecue, roast shop and other commercial purpose.*
- *Clean the cooker hood after the specified time (suggestion: every 2 months) according to the instruction manual and keep the unit from danger of burning. There is a fire risk if cleaning is not carried out in accordance with the instructions.*
- *Please keep the kitchen room with good convection before connecting this appliance; please check that the power supply cord is undamaged. A damaged supply cord must be replaced by qualified service personnel only.*
- *Regulations concerning the discharge of air have to be fulfilled.*
- *This appliance can be used by children aged from 8 years and above and also the persons with reduced physical, sensory or mental capabilities or lack of experience and knowledge if they have been given supervision or instruction concerning use of the appliance in a safe way and understand the hazards involved. Children shall not play with the appliance. Cleaning and user maintenance shall not be made by children without supervision.*
- *If the supply cord is damaged, it must be replaced by the manufacturer, its service agent or similarly qualified persons in order to avoid a hazard.*
- *There shall be adequate ventilation of the room when the range hood is used at the same time as appliances burning gas or other fuels; the range hood is only intended to be installed over a hob with no more than four hob elements; The air must not be discharged into a flue that is used for exhausting fumes from appliances burning gas or other fuels*

Range hoods and other cooking fume extractors may adversely affect the safe operation of appliances burning gas or other fuels (including those in other rooms) due to back flow of combustion gases.

These gases can potentially result in carbon monoxide poisoning. After installation of a range hood or other cooking fume extractor, the operation of flued gas appliances should be tested by a competent person to ensure that back flow of combustion gases does not occur.



CAUTION:

Accessible parts may become hot when used with cooking appliance.

Electrical Shock Hazard

Only plug this unit into a properly earthed outlet.

If you have doubts, seek advice from a suitably qualified engineer.

- Lamp type: L09 / L11;
- Shape description: round / rectangle;
- Rated wattage of the intended lamp: 1.5W;
- Max wattage of a potential replacement lamp: 1.5W;
- Rated voltage or voltage range of lamp or for pre-heat starting fluorescent lamp starter replacement detail: 110-240V;
- Nominal dimension of lamp: 68mm / 34.5 * 120mm.

Hardware Included

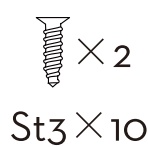
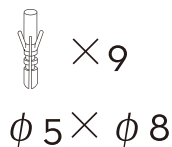
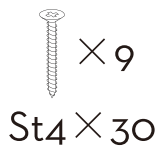
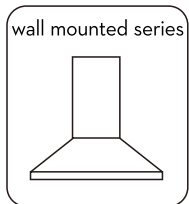

Tools Required



Pencil

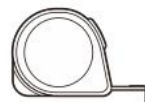

Measuring tape

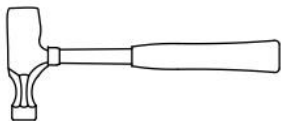

Hammer

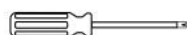

Screwdriver

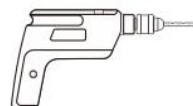
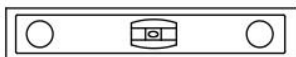

Electric drill or powered screwdriver Level

INSTALLATION INSTRUCTION

Prepare for installation:

Warning: Failure to install the screws or fixing device in accordance with these instructions may result in electrical hazards.

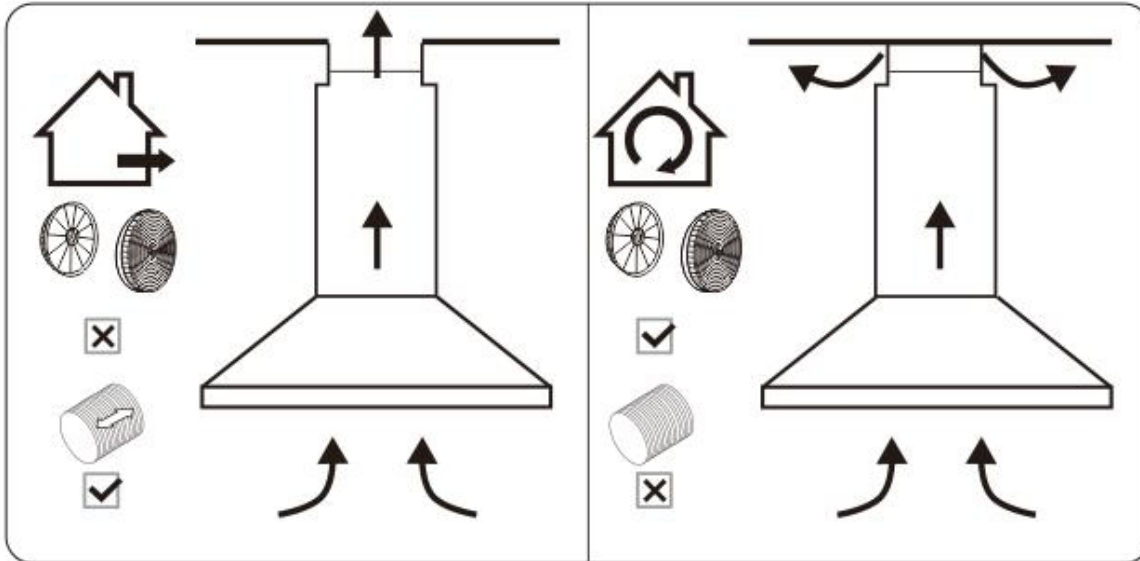

DUCTED OPTION

RECIRCULATION OPTION

a. If you have an outlet to the outside, your cooker hood can be connected as above picture by means of a pipe (with an interior diameter of 150mm). If you don't have an outlet to the outside, you can go with recirculation mode by using carbon filter.

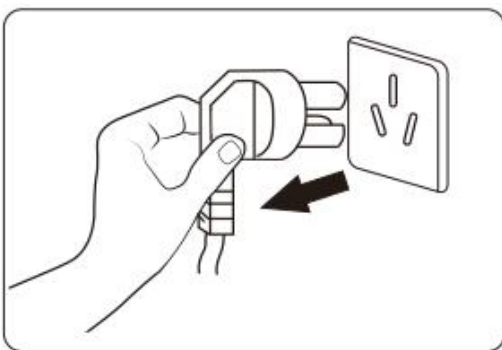

b. Before installation, turn the unit off and unplug it from the outlet.

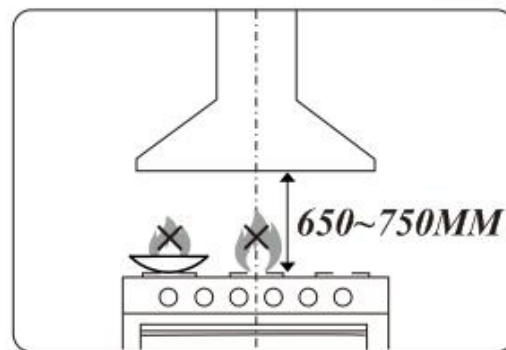

c. The cooker hood should be placed at a distance of 650~750 mm above the cooktop for the best effect.



Do not flame under the range hood.

AIR OUTLET INSTALLATION METHOD

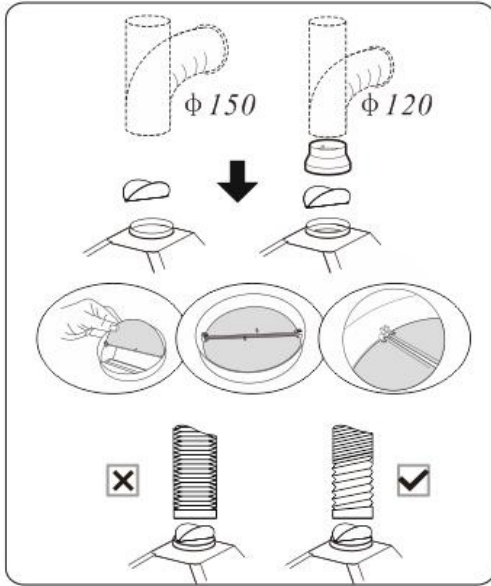

Installation method for 150mm diameter pipe: insert the one-way valve as the pic and fix the pipe.

Attention: The bump of the one-way valve must be upward.

Installation method for 120mm diameter pipe: insert the damper as the picture and fix the converter before placing the duct.

The pipe near the air outlet need to be fully extended.

WALL MOUNTING MODEL INSTALLATION

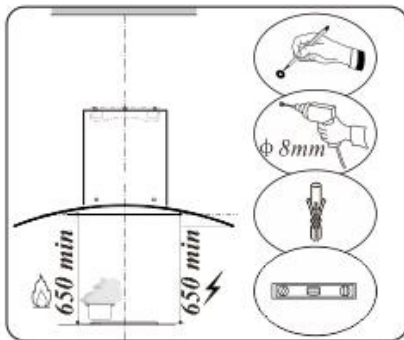

Prepare pencil, electric drill, plastic wall anchors and level before installation.
Recommended installation height: 700mm
Required minimum installation height: 650mm

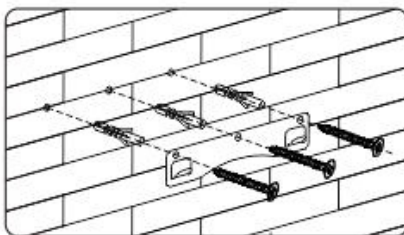

Drill 3 × 8mm holes to accommodate the bracket. Screw and tighten the hook onto the wall with the screws & plastic wall anchors provided.

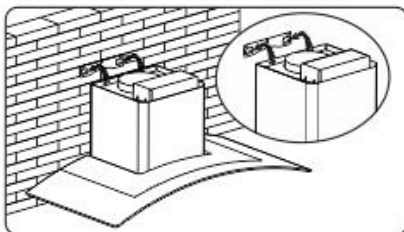

Lift the cooker hood and hang onto the wall hook.

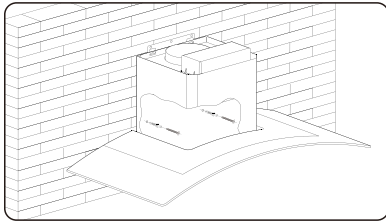

Drill 2×8mm extra holes and fix screws & plastic wall anchors before installation.

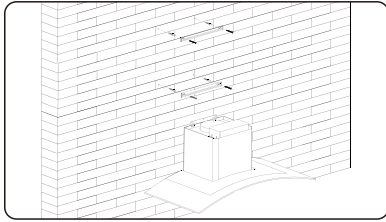

Mark down the position and drill 2 holes for each chimney bracket and tighten the bracket with screws.



Note:

The longer bracket is upper chimney bracket

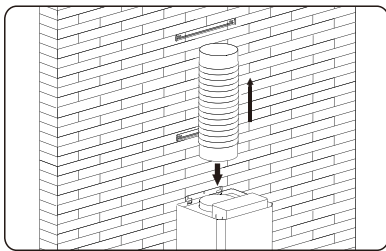

Fix the one-way-valve to the air outlet of the cooker hood, and then attach the pipe onto the air outlet as picture.

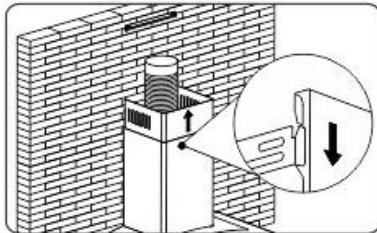

Put the upper chimney into lower chimney . Then pulling out the upper chimney upwards. Adjust to reach the height required.

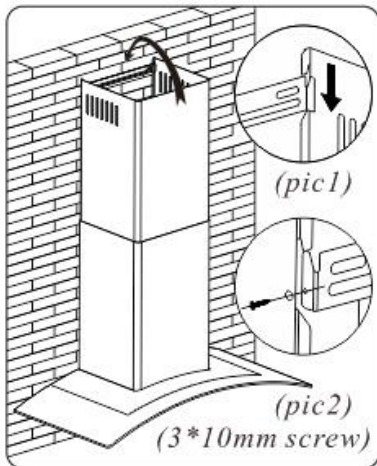

There are 2 methods for installing the chimney cover. Please check the attached pic for reference.

1.After drilling the 2 holes and fixing the bracket, hang the chimney cover by matching the both side locks.(Pic1)

2.After drilling the 2 holes and fixing the bracket, install the chimney cover by locking with 2 screws in both side holes.(Pic2)

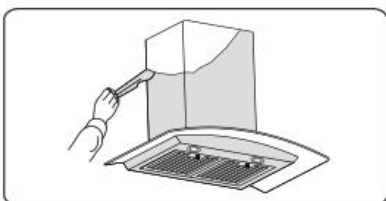

BEFORE USE



Note

Please remove the white/blue protective film on the range hood, chimney covers and baffle filters. (Only for stainless steel finish)

OPERATION

Push Button



- ① **OFF Button**
Turn off the fan.
- ① **Low Speed Button**
*Start the fan at low speed .
It is suitable for simmering and cooking
which does not make much steam.*
- ② **Medium Speed Button**
*Start the fan at medium speed.
This is ideal for ventilation during standard cooking operation.*
- ③ **High Speed Button**
*Start the fan at high speed.
This is ideal for ventilation when a high density of smoke or
steam has been produced.*
- ☀ **Light Button**
Used for turning on/off the light.

MAINTENANCE

Before cleaning switch the unit off and pull out the plug.

I. Regular Cleaning

Use a soft cloth moistened with hand-warm mildly soapy water or household cleaning detergent. Never use metal pads, chemical, abrasive material or stiff brush to clean the unit.

II. Bulb Replacement

- 1.Switch the unit off and unplug the appliance.*
- 2.Remove the lamp cover by unscrewing the 2 screws.*
- 3.Unscrew the incandescent bulb*
- 4.Replace with the same type and rated bulb/lamp*
 - E14 Incandescent Bulb: (E14 Max 40W).*
 - Lamp type: L09 / L11;*
 - Shape description: round / rectangle;*
 - Rated wattage of the intended lamp: 1.5W;*
 - Max wattage of a potential replacement lamp: 1.5W;*
 - Rated voltage or voltage range of lamp or for pre-heat starting
fluorescent lamp starter replacement detail: 110-240V;*
 - Nominal dimension of lamp: 68mm / 34.5 * 120mm.*

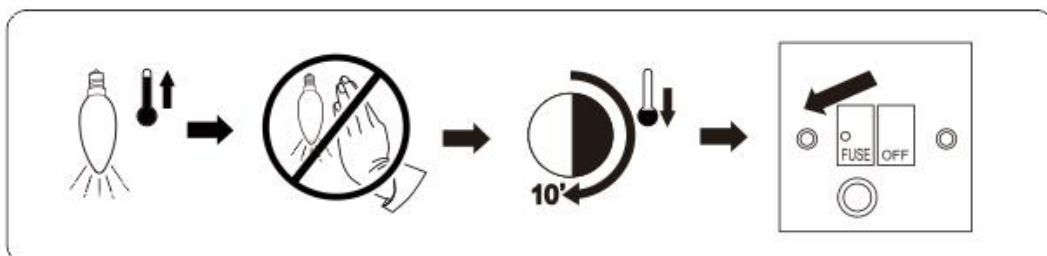

The Bulb may be hot. leave it 10 minutes before replacement.

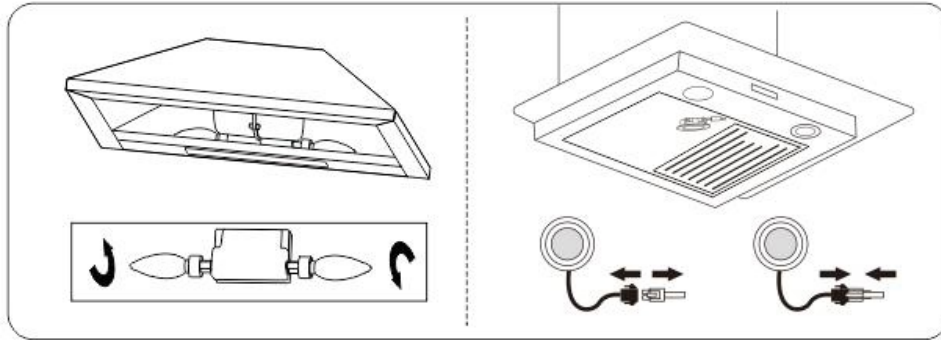

III. Aluminium and carbon filters replacement

In order to install the carbon filter, the grease filter should be detached first. Press the lock and pull it downward.

Carbon filter is NOT included, need to order it separately.

Aluminium filters: To avoid fires, clean thoroughly once a month or whenever the display pilot lights up (if fitted). To do so, remove the filters and soak in hot water and detergent for an hour. If using a dishwasher, position the filters vertically to improve the cleaning process.

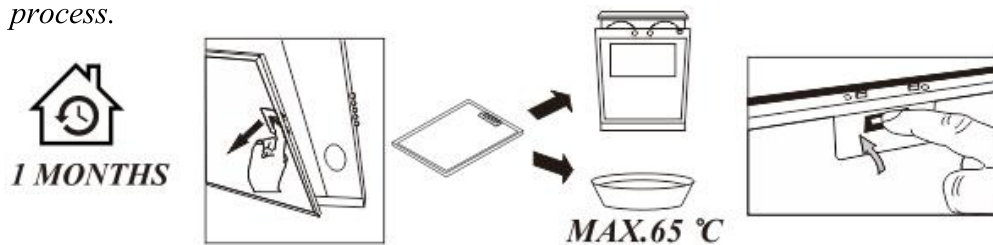

Installation: Fix carbon filter into the unit and turn it in clockwise direction. Repeat the same on the other side.

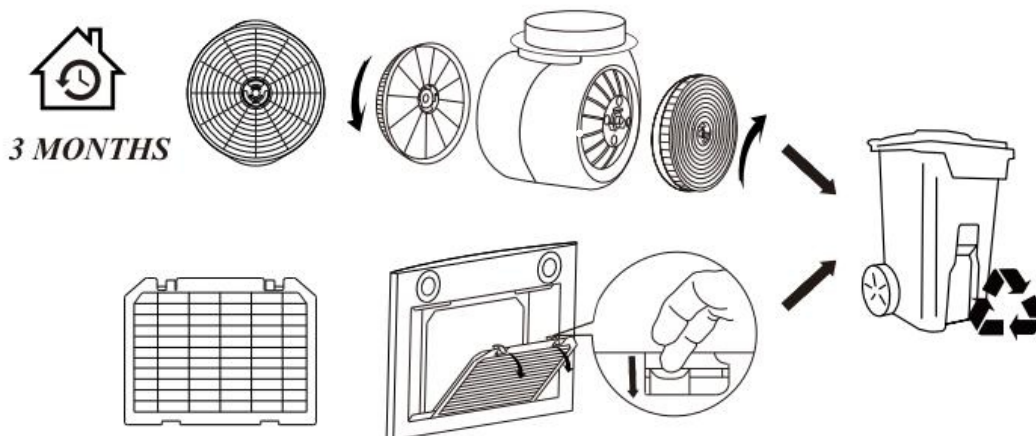

Important Notice:

1. Make sure the filter is securely locked. Otherwise, it would loosen and cause abnormal noise and danger.
2. Using carbon filter would reduce the air flow of the range hood.

VI. Carbon filter life time: Suggest changing to new one every 3 months (According to different kitchen condition, the life time of carbon filter might be longer or shorter than 3 months). Carbon filter is NOT included, need to order it separately.

TROUBLE-SHOOTING

<i>Problem</i>	<i>Possible cause</i>	<i>Solution</i>
<i>Light on, but fan does not work</i>	<i>The fan blade is jammed.</i>	<i>Switch off the unit and repair by qualified service personnel only.</i>
	<i>The motor is damaged.</i>	
<i>Both light and fan do not work</i>	<i>Light bulb burn.</i>	<i>Replace the LED light with correct rating.</i>
	<i>Power cord is loose.</i>	<i>Plug into the power supply again.</i>
<i>Serious Vibration of the unit</i>	<i>The fan blade is damaged.</i>	<i>Switch off the unit and repair by qualified service personnel only.</i>
	<i>The fan motor is not fixed tightly.</i>	
	<i>The unit is not hung properly on the bracket.</i>	<i>Take down the unit and check whether the bracket is in proper location.</i>
<i>Suction performance not good</i>	<i>Too far distance between the unit and the cooktop.</i>	<i>Readjust the distance between 650-750mm.</i>

ENVIRONMENTAL PROTECTION

Waste electrical products should not be disposed of with household waste.

Please recycle where facilities exist.

Check with your Local Authority or retailer for recycling advice.

