

# USER MANUAL

## TOUGH TOOLS, HALF PRICE

Technical Support and E-Warranty Certificate

## WALK IN CHICKEN COOP

We continue to be committed to provide you tools with competitive price. "Save Half", "Half Price" or any other similar expressions used by us only represents an estimate of savings you might benefit from buying certain tools with us compared to the major top brands and does not necessarily mean to cover all categories of tools offered by us. You are kindly reminded to verify carefully when you are placing an order with us if you are actually saving half in comparison with the top major brands.

**WALK IN**

**CHICKEN COOP**

**TOUGH TOOLS, HALF PRICE**

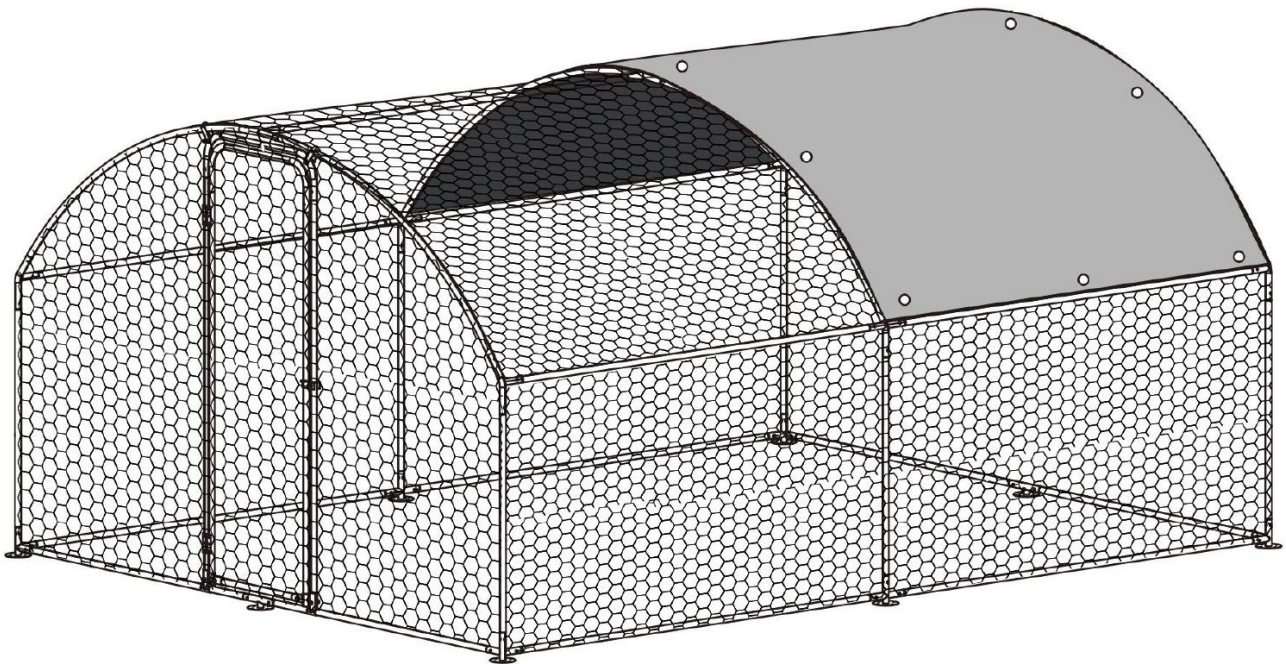

This is the original instruction, please read all manual instructions carefully before operating. **Supplier** reserves a clear interpretation of our user manual. The appearance of the product shall be subject to the product you received. Please forgive us that we won't inform you again if there are any technology or software updates on our product.

# Safety precautions

## WARNING:

**Read this instructions** before using this product. Failure to do so can result in serious injury. the basic precautions should always be followed,including the following:

1. The walk in chicken coop may not be used or stored in hazardous areas. It is not allowed to use the appliance in hazardous locations.
2. The walk in chicken coop must be checked to ensure that it is in proper working order and is operating safely prior to use. Otherwise,the appliance must not be used.
3. Please clear the roof of the snow regularly, as too much snow will collapse the tarpaulin.
4. The operator must use the walk in chicken coop properly. He must consider the local conditions and must pay attention to third parties,in particular children,when working with the walk in chicken coop.
5. This walk in chicken coop is not intended for use by persons (including children) with reduced physical,sensory or mental abilities or lacking experience and/or knowledge,unless they are super- vised by a person responsible for their safety or are instructed by these persons on the use of the device. Children should be supervised,to ensure that they do not play with the walk in chicken coop.

## SAVE THESE INSTRUCTIONS

# Product List



1 x4pcs 1410mm pipe



3 x6pcs 970mm pipe

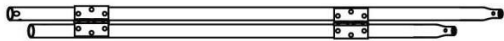

D1 x1pc 1735+1665mm pipe



2 x10pcs 1870mm pipe



4 x6pcs x1650mm pipe



D2 x1pc 1735mm pipe



D3 x1pc x820mm pipe



D4 x1pc 920mm pipe



D5 x1pc 1665mm pipe



D6 x1pc 510mm pipe



A x4pcs



B x2pcs



C x4pcs



D x2pcs

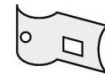

E x8pcs

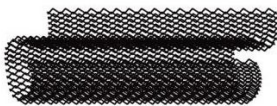

F 1.1x38m



G x1pc Roof

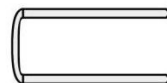

H x8pcs



I x2bag



J x14pcs



K x2pcs

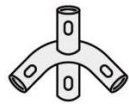

L x2pcs

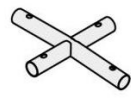

W x1pcs

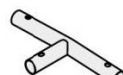

Y x2pcs

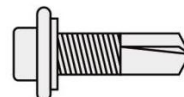

M2 x10pcs



M8x50mm

M1 x 8pcs  
spare part x2pcs



P x1pcs

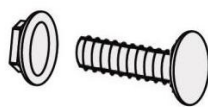

Q x1pcs



V x1pcs



**Step 2:** Gather pipe "3" x4pcs,insert the pipes into the connertors. Before this,please put the plastic connector "G" x4pcs on corner of pole "3" x4pcs like bellow (note:only for 4pcs of pole 3 in the corner need this plastic connectors) .

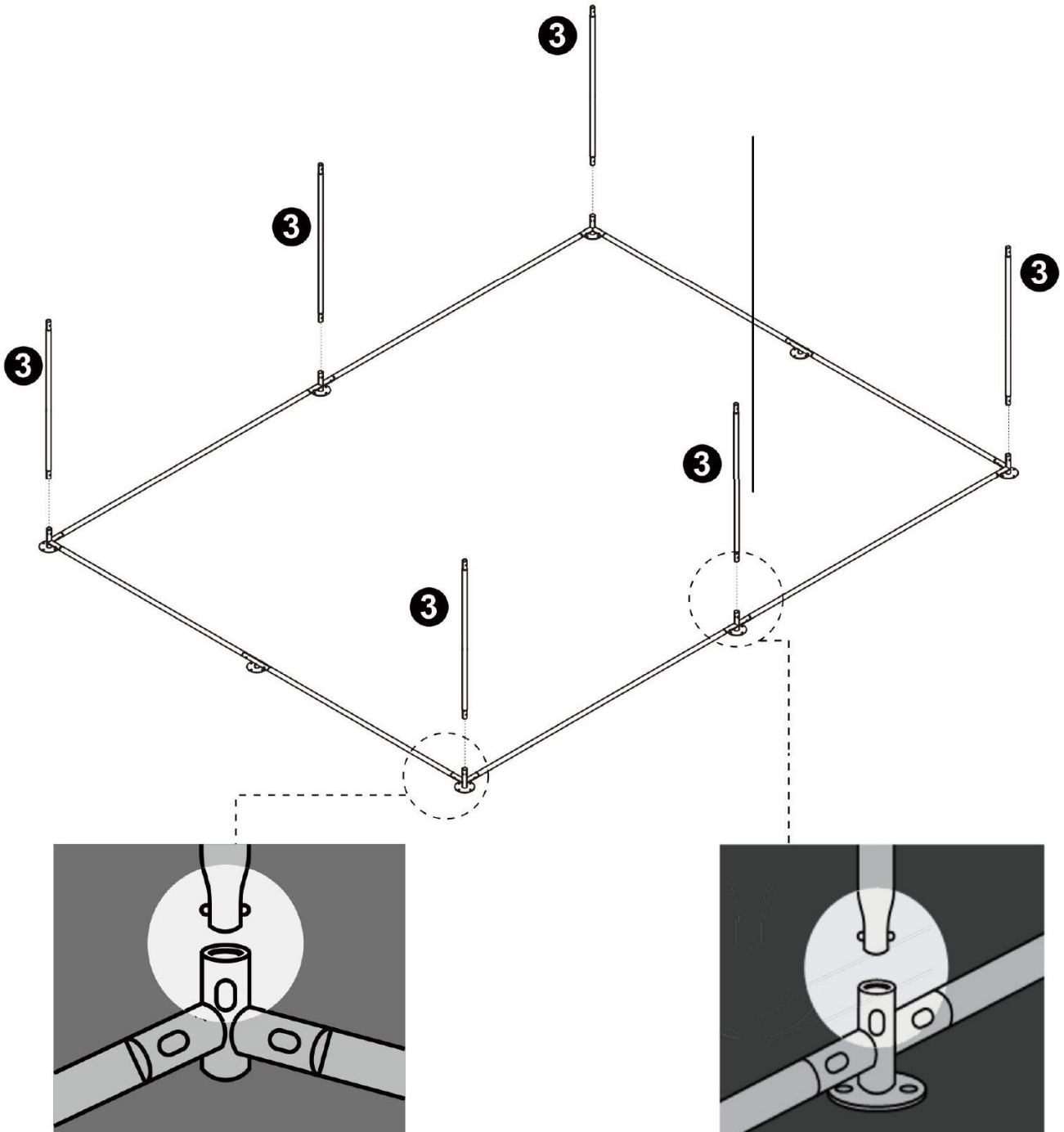

**Step 3:** Gather connector "A" x4pcs,"B" x4pcs,and pipe"2"x6pcs,assemble as the below drawing.

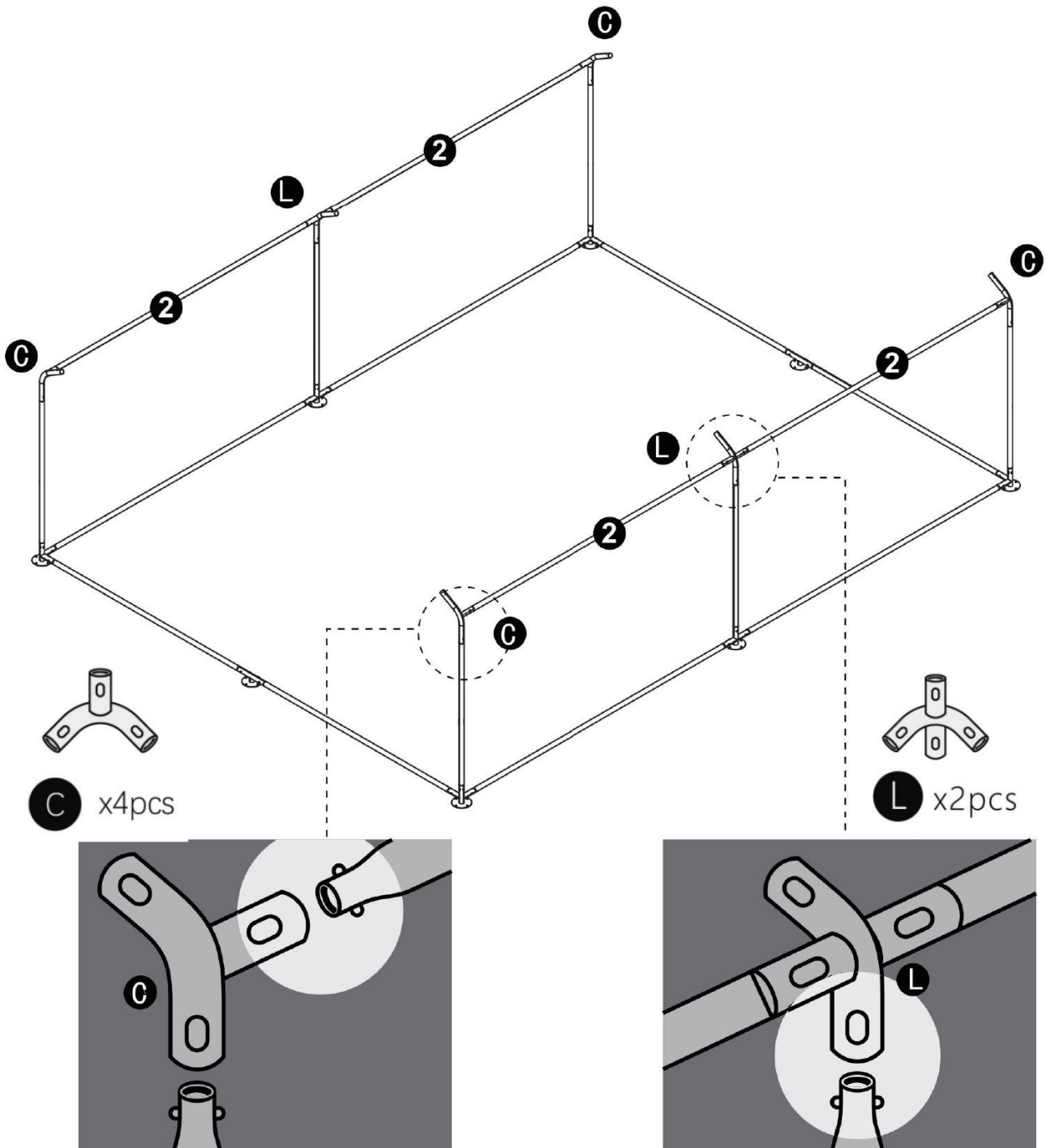

**Step 4:** Gather connector "Y" x2pcs, "X" x1pc, and pole "2" x3pcs, and pole "4" x8pcs assemble like bellow.

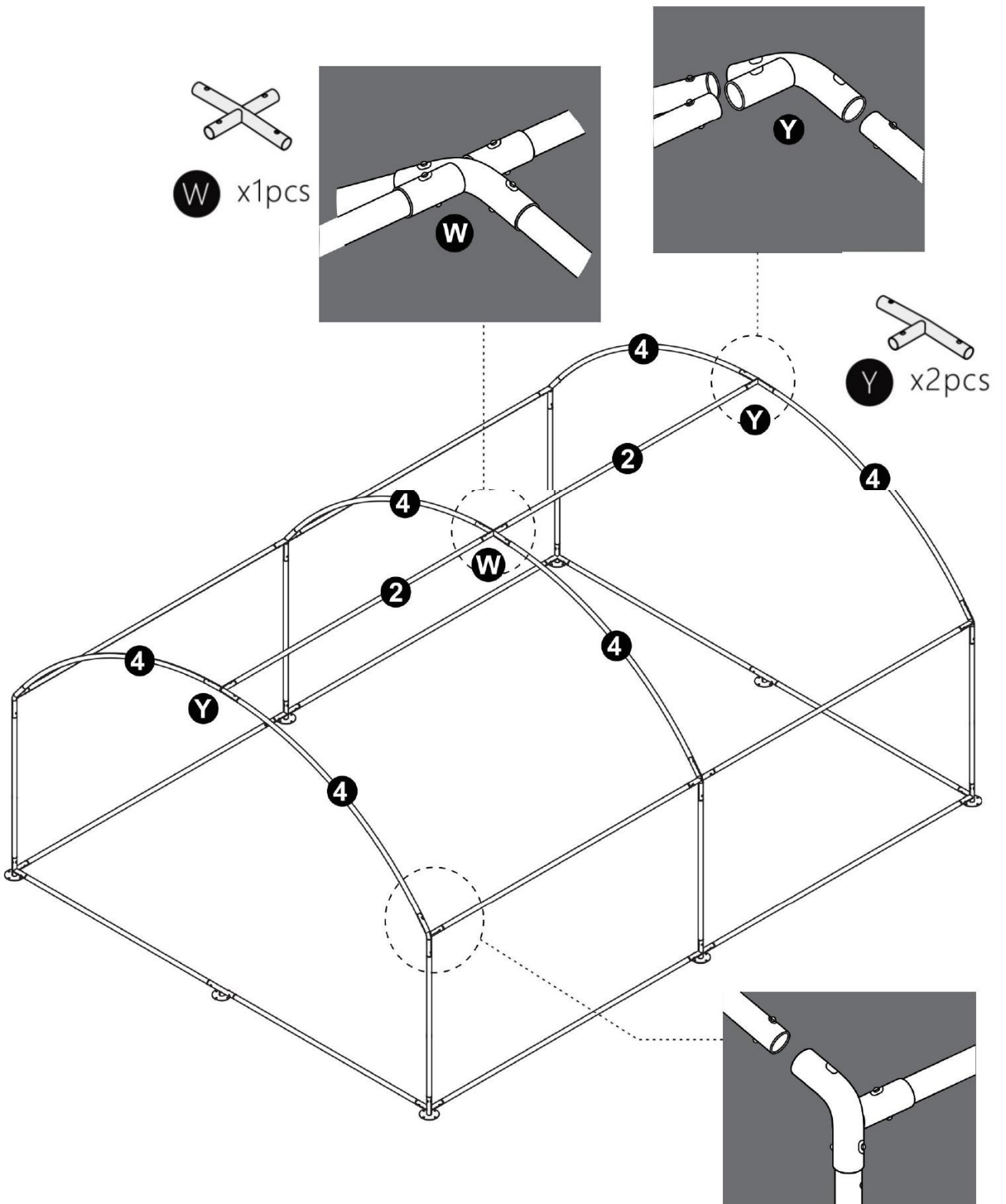

**Step 5:** Install the chicken coop door frame as shown.

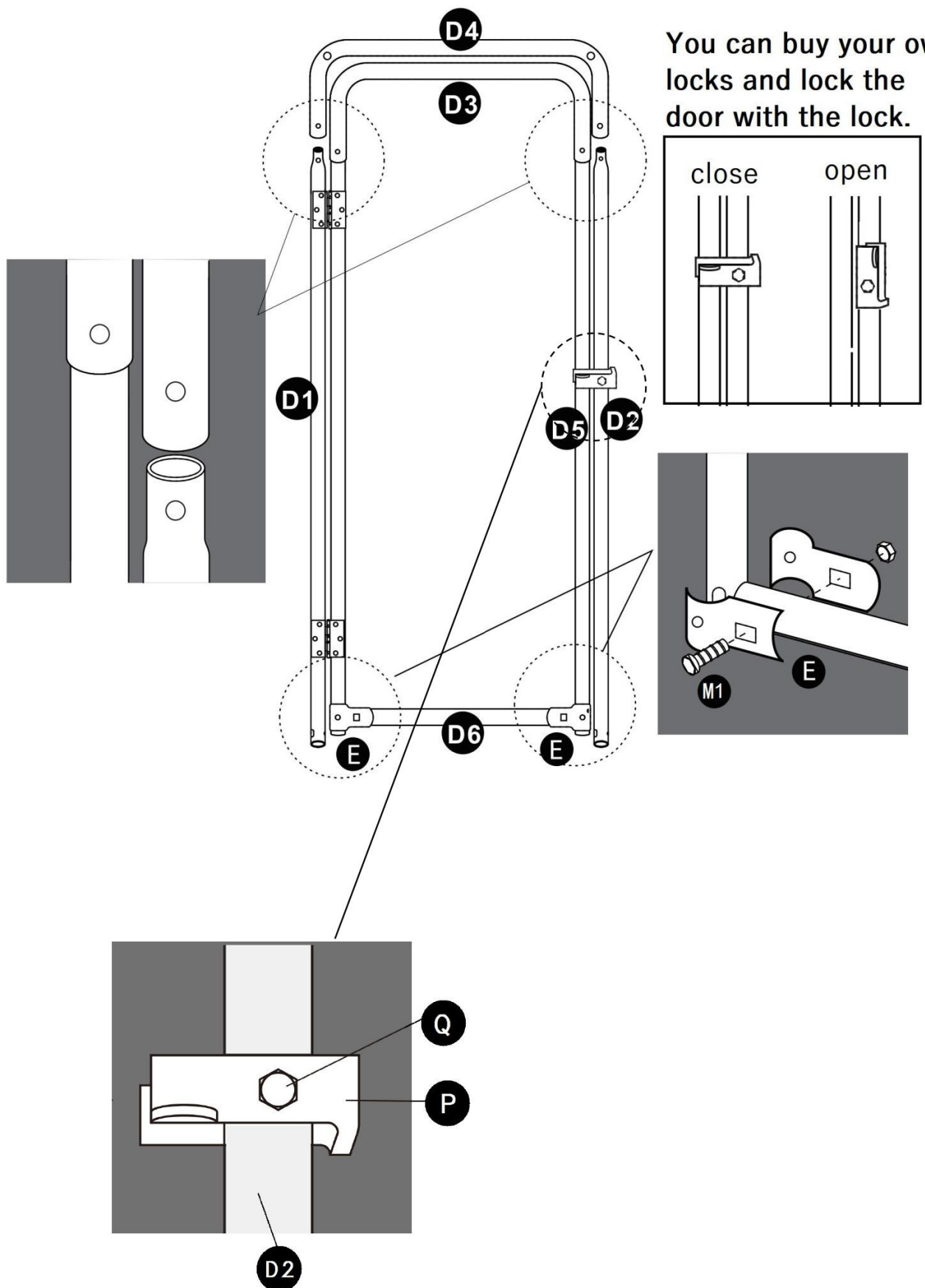

**Step 6:** Attach the door to the coop door frame.

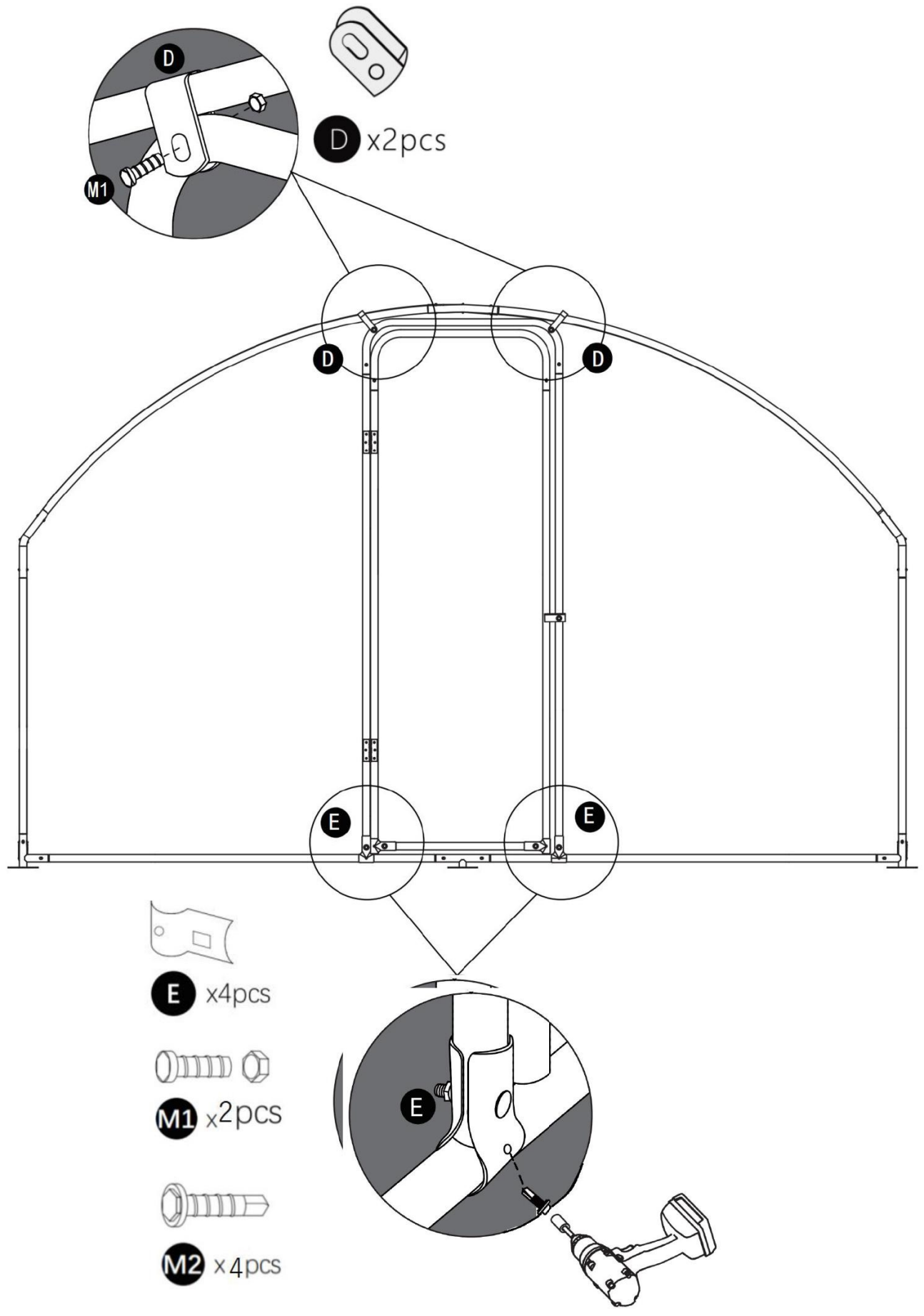

**Step 7:** Install the chicken ladder to the frame.

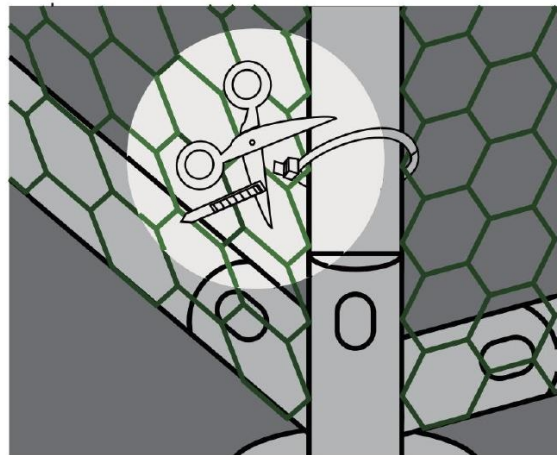
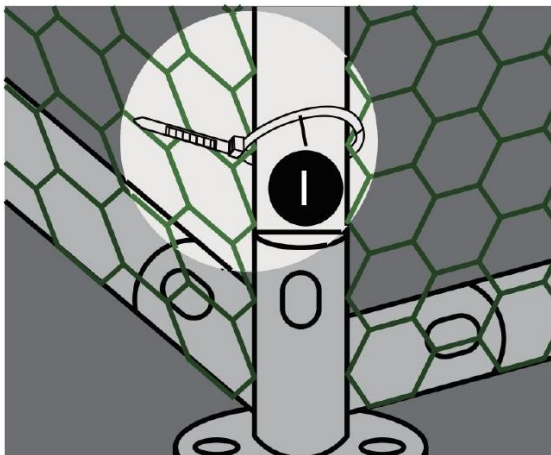
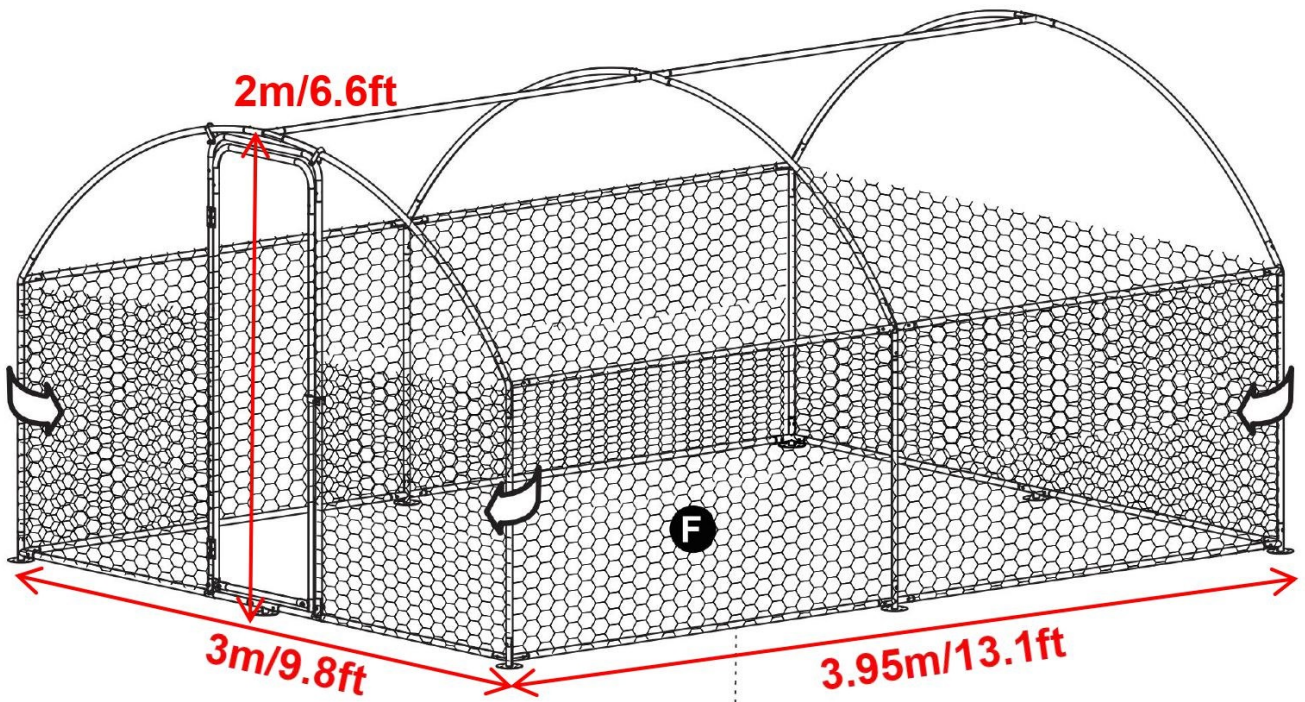

**Step 8:** For the front and back blanks, cut the wire mesh (F) to the right shape and then fix it to the coop frame.

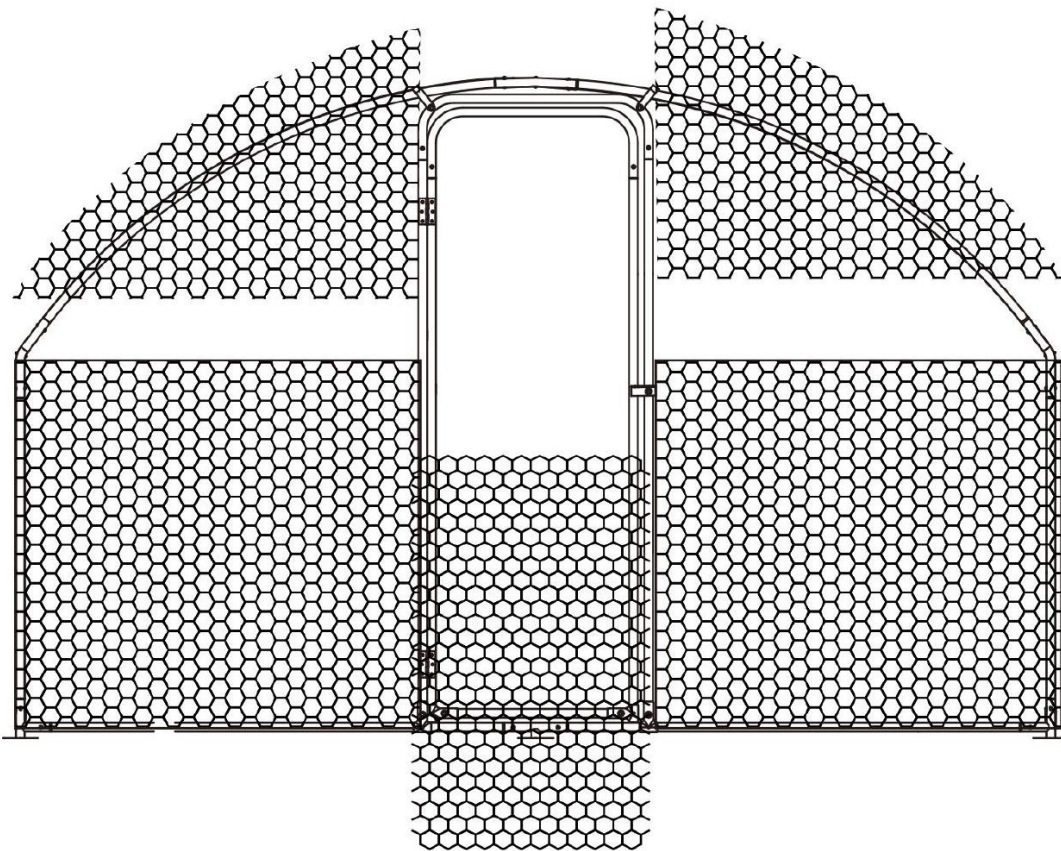

**Front**

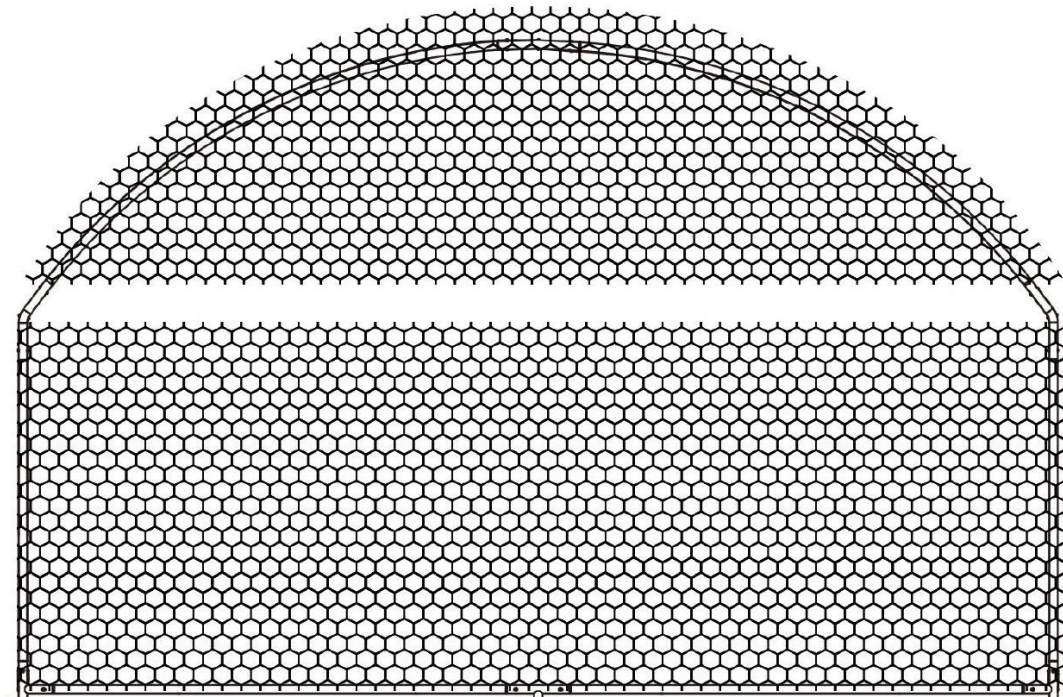

**Back**

**Step 9:** Lay the tarpaulin (G) flat over the top of the coop and secure it with the bungees (O) .

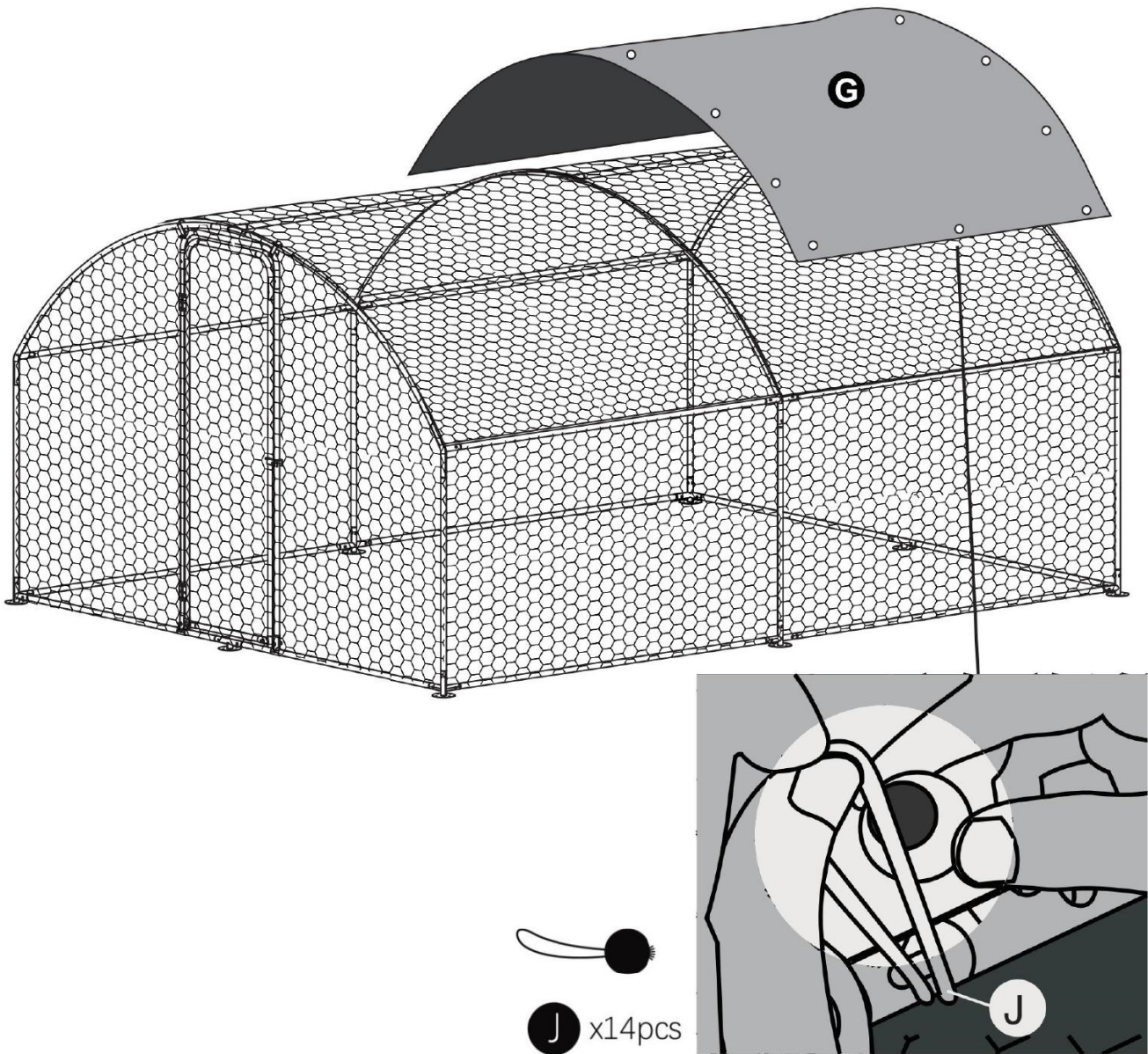

**Use a bungee cord to pass through the hole in the rain proof cloth to secure the rain proof cloth.**

**Step 10:** Finally, use ground nails (M) to fix the installed chicken coop on the ground to make it more firm.

