

ASSEMBLY INSTRUCTION









IMPORTANT SAFETY CONSTRUCTION

Thank you for purchasing this quality product. Be sure to check all packing material carefully for small parts that may have come loose inside the carton during shipment. Please read all instruction carefully before assembling. For your safety, assembly by two people is recommended.

PARTS INCLUDED:

- (1) Chair Back (a)
- (1) Complete Seat (b)
- (1) Left Leg (c)
- (1) Right Leg (d)
- (1) Left Facing Side Stretcher (e)
- (1) Right Facing Side Stretcher (f)

HARDWARE ENCLOSED:

- A 4x  Ø6 x 75mm
- B 2x  Ø6 x 40mm
- C 4x  Ø8 x 13mm
- D 10x  Ø8 x 13mm
- E 10x  Ø8 x 19mm
- F 1x  ✓
- G 1x  ✓
- H 4x  Ø4 x 45mm

ASSEMBLY INSTRUCTIONS

STEP 1:

- Carefully lay Chair Back flat on a smooth flat surface to prevent scratches.
- Affix Complete Seat to Chair Back by inserting a Flat Washer (G), Lock Washer (F) with Short Bolt (B) into each of the hole on the back rail of the seat, and Long Bolt (A) into each of 2 holes in the Complete Seat corners. (See Detail A & B).
- Tighten screws with provided Allen Key (H) by turning clockwise until secure

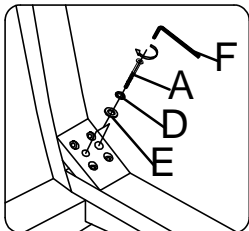
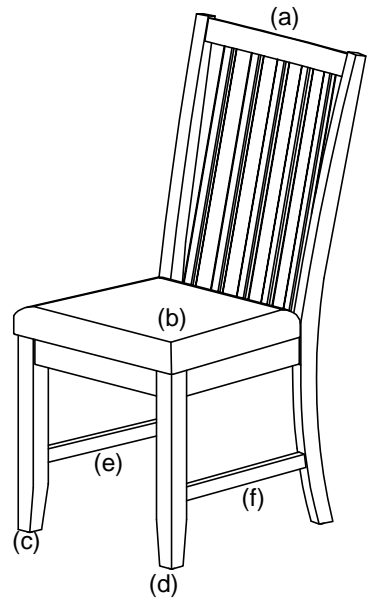

DETAIL B:

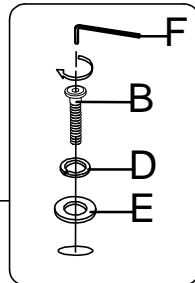

DETAIL A:

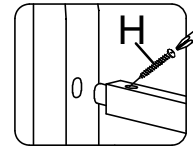

DETAIL D:

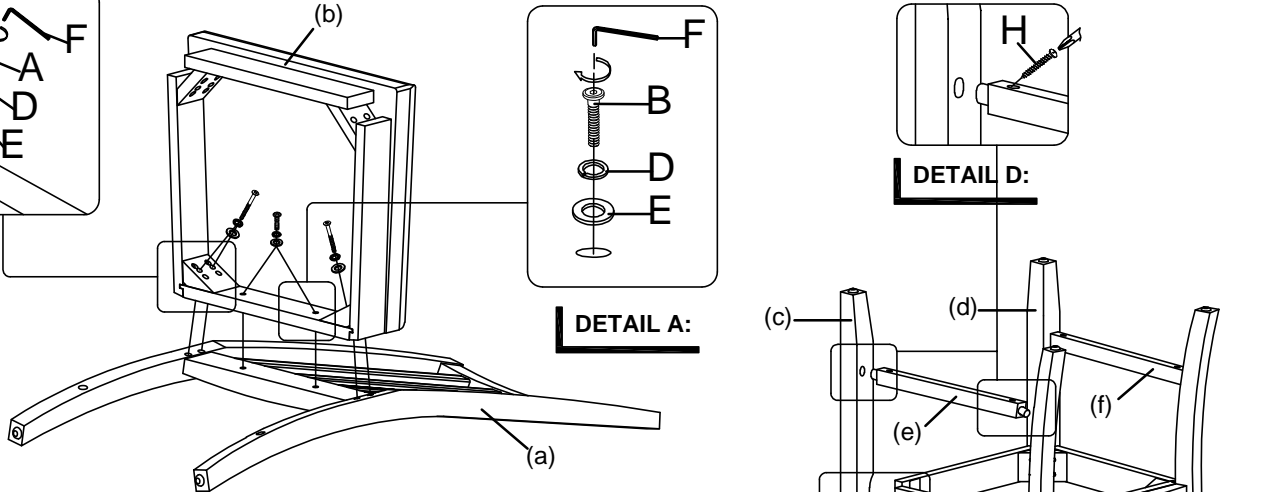

STEP 2:

- Carefully turn chair upside down and affix each Leg to the front corners of the Complete Seat. Place Flat Washer (E), Lock Washer (D) and nut (C) on to the bolts of each Leg.
- Do not fully tighten the nuts at this stage until all the parts are in position. (See Detail C)
- Insert 2 Side Stretchers between the Front legs and Rear legs, fasten with Wood Screw using phillip-head screwdriver (not provided). (See Detail D)
- Be sure to level the chair prior to tightening all the bolts/screws.

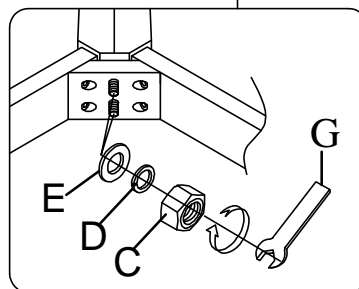

DETAIL C:

NOTES:

The use of power tools for assembly is not recommended. Power tools can damage hardware or split wood.