







ASSEMBLY INSTRUCTION

BOX OF NIGHTSTAND PART LIST

ITEM	DRAWING	DESCRIPTION	QTY
A		NIGHTSTAND	1
B		LEG (B) (Located in the bottom drawer)	2
C		LEG (C) (Located in the bottom drawer)	2

BOX OF NIGHTSTAND HARDWARE LIST

ITEM	DRAWING	DESCRIPTION	QTY
1		WOOD DOWEL M8x30mm	4
2		JCBC SCREW M6x40mm	4
3		L-KEY M4x65mm	1
4		TIPPING RESTRAINT (Affix to wall behind nightstand) *Located in the Nightstand 1st Drawer	1

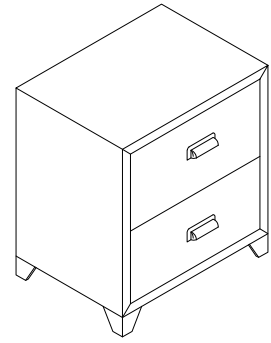

COMPLETED NIGHTSTAND ASSEMBLY

STEP 1

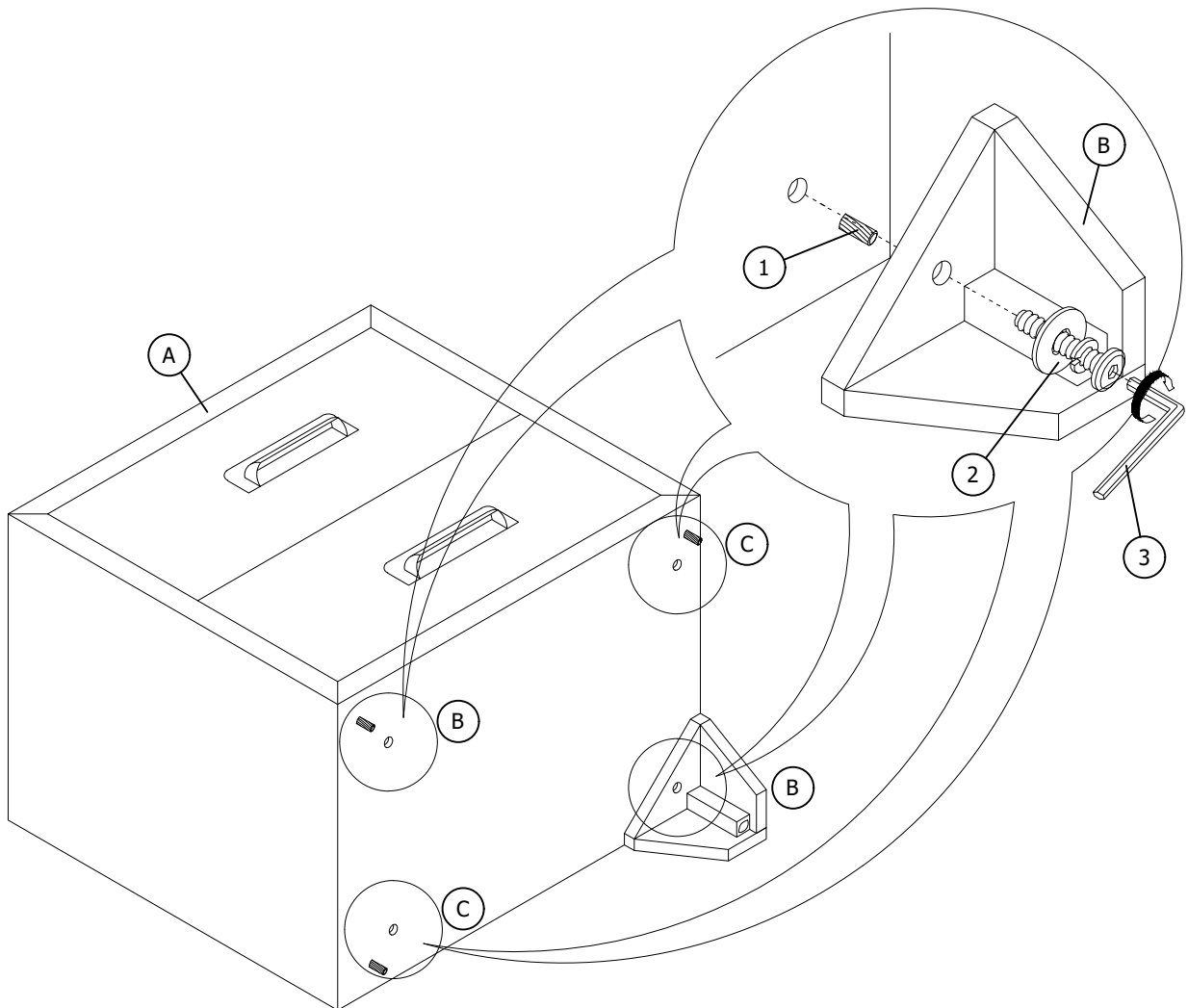

THE HARDWARE IS LOCATED IN THE PACKING ITEMS
THE ANTI TIPPING HARDWARE IS LOCATED IN THE NIGHTSTAND 1ST DRAWER





PAGE 01 OF 02

NOTE : Periodically check to ensure that all connectors (bolts, screws, etc.) are tight.

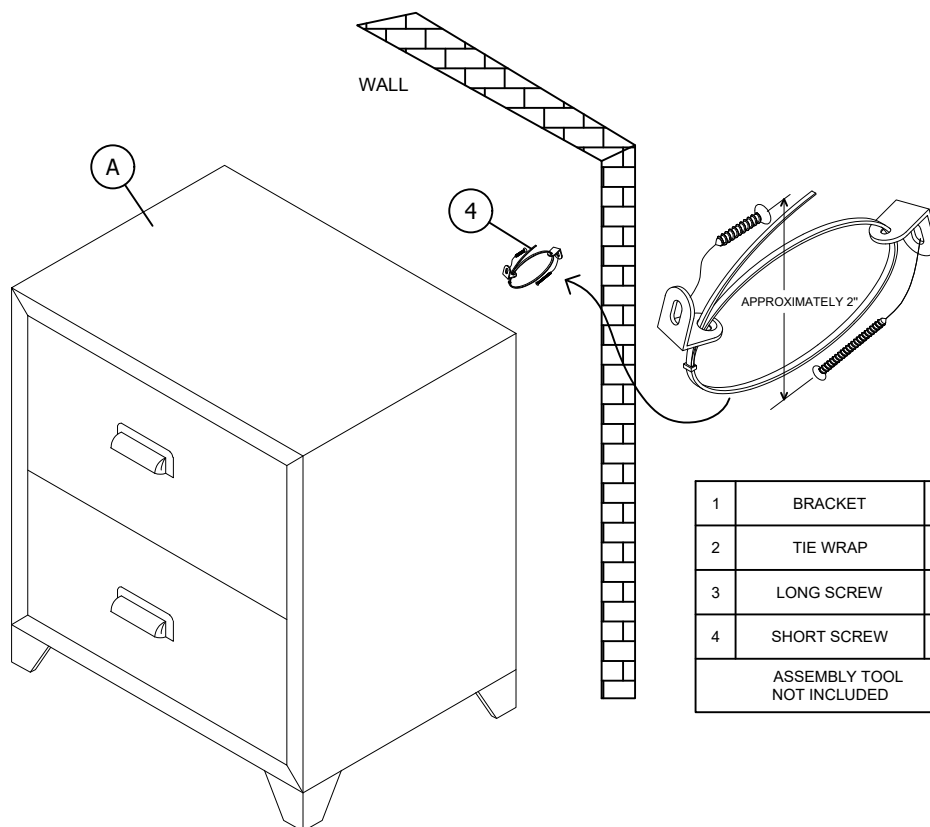
ASSEMBLY INSTRUCTION

STEP 2

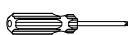

1	BRACKET		2PCS
2	TIE WRAP		1PC
3	LONG SCREW		1PC
4	SHORT SCREW		1PC
ASSEMBLY TOOL NOT INCLUDED			

THE HARDWARE IS LOCATED IN THE PACKING ITEMS
THE ANTI TIPPING HARDWARE IS LOCATED IN THE NIGHTSTAND 1ST DRAWER

PAGE 02 OF 02

NOTE : Periodically check to ensure that all connectors (bolts, screws, etc.) are tight.