

Assembly Instructions







COUNTER CHAIRS

Thank you for purchasing this quality product. Be sure to check all packing materials carefully for small parts, which may have come loose inside the carton during shipment. Identify and count all items and compare with the PARTS LIST and/or HARDWARE LIST shown below.







Caution: Please read the instructions thoroughly before assembly.

1. We recommend that you assemble this product with the assistance of another person; this will make the assembly easier, and will help eliminate damage to the product or injury to persons during assembly.
2. Please do not over tighten screws or bolts until the assembly is completed.
3. Please put all parts on a non-abrasive floor before assembly, and follow the assembly steps to assemble your newly purchased product correctly and efficiently.

PARTS LIST

NO:	COMPONENT	SKETCH	Q'TY
A	CUSHION SEAT		2PCS
B	CHAIR BACK		2PCS
C1	SIDE STRETCHERS LEFT		2PCS
C2	SIDE STRETCHERS RIGHT		2PCS
D	FRONT STRETCHERS		2PCS
E1	FRONT LEGS LEFT		2PCS
E2	FRONT LEGS RIGHT		2PCS

HARDWARE LIST

NO:	COMPONENT	SKETCH	Q'TY
1	LOCK WASHERS Ø5/16"		22PCS
2	FLAT WASHERS Ø5/16"		22PCS
3	BOLTS Ø1/4" x 45mm		6PCS
4	BOLTS Ø1/4" x 75mm		8PCS
5	NUTS Ø5/16"		8PCS
6	ALLEN WRENCH Ø5/16"		1PC
7	WOOD SCREWS Ø4 x 38mm		12PCS

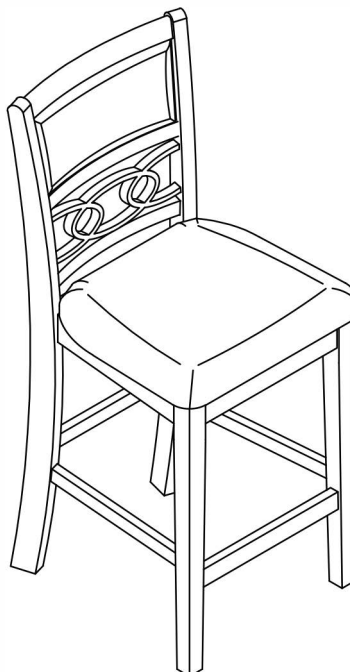

Assembly Instructions

COUNTER CHAIRS

STEP:1

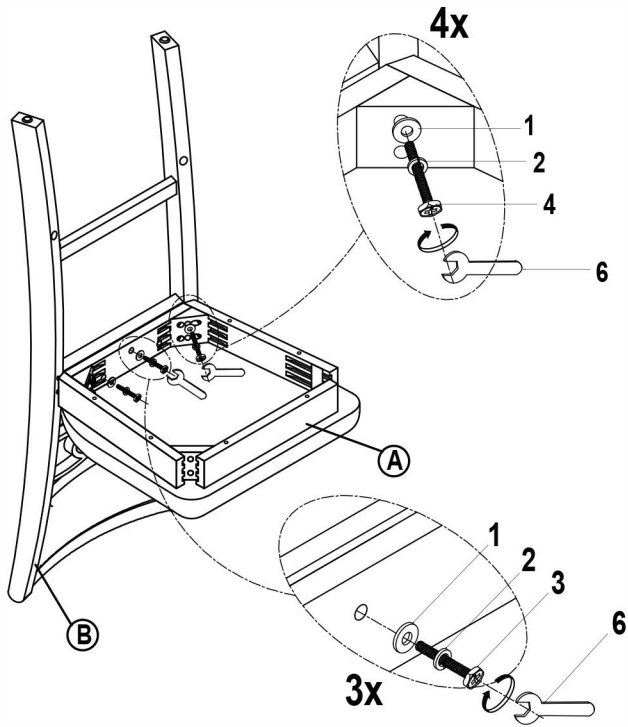

STEP:2

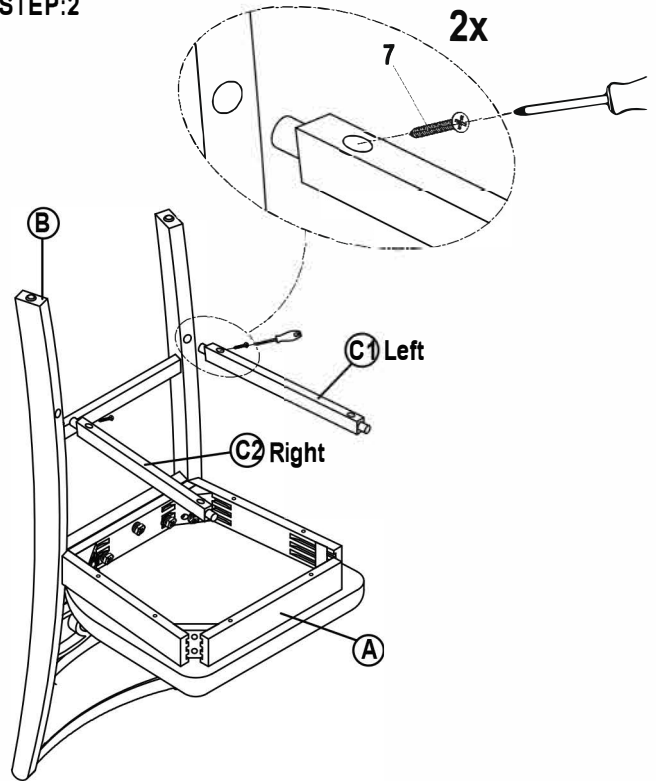

STEP:3

