

# INSTRUCTION MANUAL

## COMPRESSOR WINE CELLAR COMPRESSOR BEVERAGE REFRIGERATOR

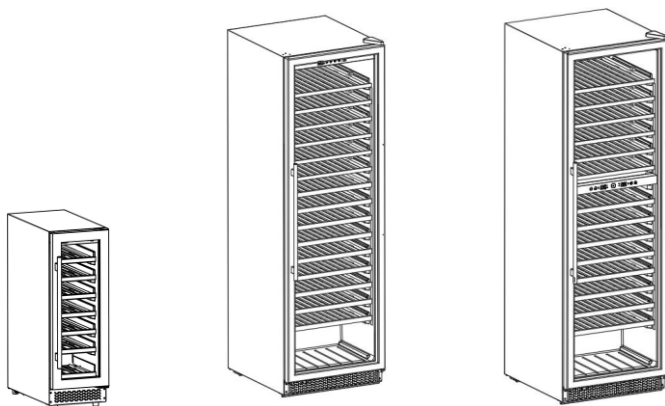

MODEL: JCS-58QYL / JCS-58QE / JCS-408E / JCS-508E / JCS-408QE / JCS-508QE / JCD-508QE

Thank you for your order.

You made our day.

Thanks for your purchase.

If any problems with our commodity, Please feel free to contact us

Please refer to the model on the nameplate of the machine.

Please read the user manual carefully before use and keep it properly

Note Model: JCS-58QYL is a beverage refrigerator, Temperature setting range 37~64°F

Door Hinges: Left and Right interchangeable

**Email: [support@vushineshop.com](mailto:support@vushineshop.com)**

MADE IN CHINA

## ■ BEFORE FIRST USE:

Please leave the product sitting outside the box for 48 HOURS before plugging it in.

The product may have been tilted or placed upside down during shipping. Leave the product sits for 48 hours so the oil in the compressor can settle from the move, Not doing so can affect the performance or the product.

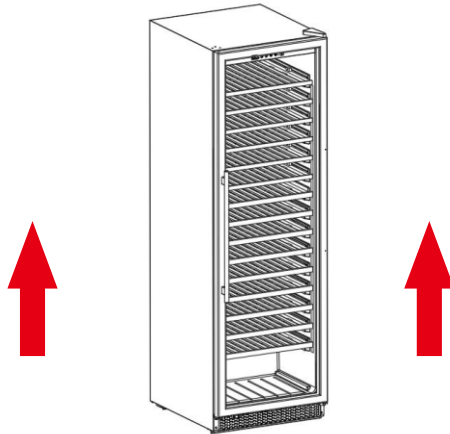

### Note:

In order to continuously improve its products, we reserve the right to modify this information without prior notice. If you have any questions during assembly and use, please refer to the instructions on the product page for reference. Or if you have any questions, comments or concerns, please contact our customer service. We are online 24 hours a day, at your service at any time. Thank you for using our products at home!

**[Email:support@vushinshop.com](mailto:support@vushinshop.com)**

# Operating Instructions



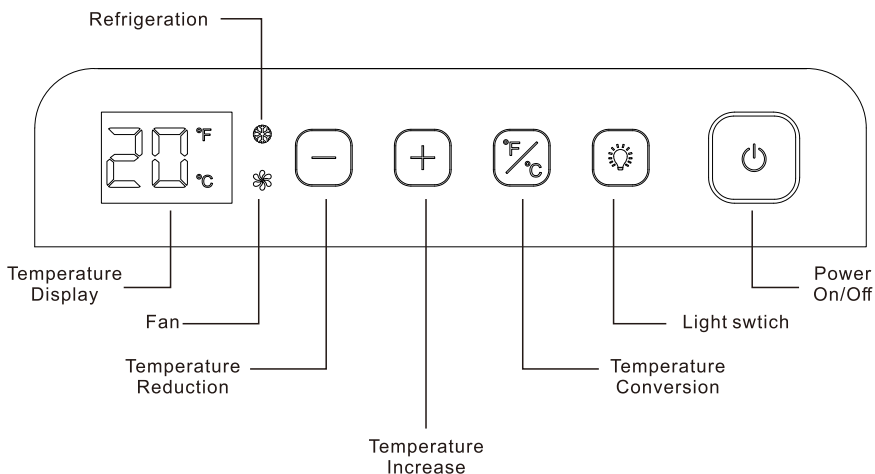

**Turn off the machine:** Long press the “” key for 3s

**Turn on the machine:** Touch the “” key  
(No need to long press)

**Model: JCS-58QYL / JCS-58QE**



## ■ Key Description

	Temperature up button Temperature Increase		Temperature conversion key Control temperature unit conversion
	Temperature down button Temperature Reduction		LED Light switch To turn the light on/off
	Power button To turn the machine on/off.		

# Product Parameters

Model	Product size (In)	Volume (Cu.ft)	Number of Plies	Temperature Range (°F)
JCS-58QYL	11.6W*22.6D*34.2H(IN)	2	3	37~64°F
JCS-58QE	11.6W*22.6D*34.2H(IN)	2	7	41~64°F
JCS408E	23.6W*27.5D*63H(IN)	14.4	13	41~64°F
JCS508E	23.5W*27.5D*72.8H(IN)	17.2	15	41~64°F
JCS-408QE	23.6W*26.8D*66H(IN)	14.4	13	41~64°F
JCS-508QE	23.5W*27.5D*72.8H(IN)	17.2	15	41~64°F
JCD-508QE	23.5W*27.2D*75.7H(IN)	17.1	14	41~54°F/54~64°F

## Warm tips:



**Water on the glass:** This is because the temperature inside the machine when the door is opened and the temperature difference between the outside environment is too large formation, when you close the door again 10 minutes after the water on the glass will disappear

**Alarm-Open the door for more than 5 minutes without closing the door, the machine will sound an alarm, this is a normal phenomenon, after closing the door will lift the alarm sound.**

# Model: JCS-408E / JCS-408QE / JCS-508E / JCS-508QE

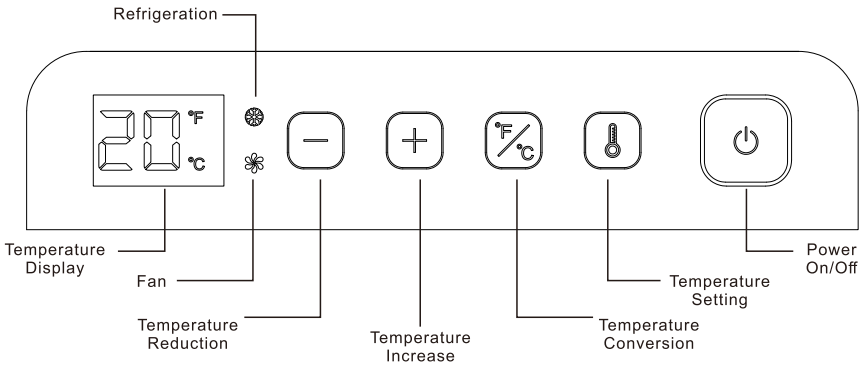

## ■ Key Description

	<b>Temperature up button</b> Temperature Increase		<b>Temperature conversion key</b> Control temperature unit conversion
	<b>Temperature down button</b> Temperature Reduction		<b>Temperature Settings</b>
	<b>Power button</b> To turn the machine on/off.		

## Model: JCD-508QE

**Temperature zone selection:** Press “①” key to select upper or lower temperature zone.

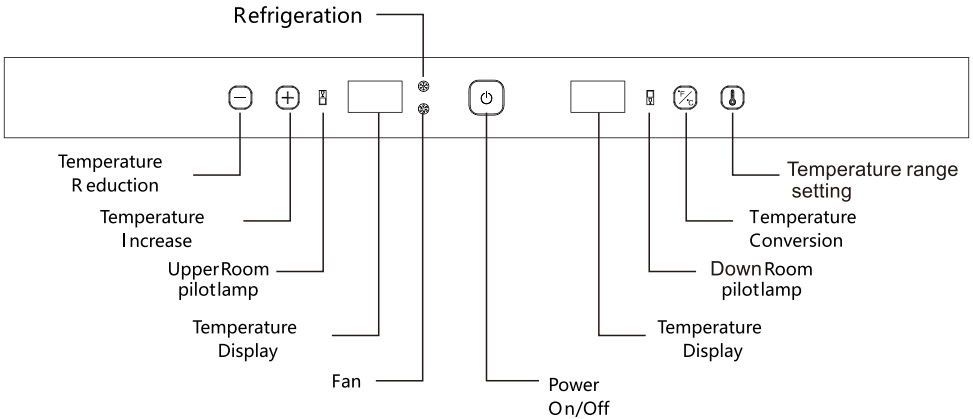

### ■ Key Description

	<b>Temperature up button</b> Temperature Increase		<b>Temperature conversion key</b> Control temperature unit conversion
	<b>Temperature down button</b> Temperature Reduction		<b>Upper and lower temperature zone selection</b>
	<b>Power button</b> To turn the machine on/off.		

# Thanks again for your purchase.

Thanks for your purchase.

If any problems with our commodity, Please feel free to contact us

## Instructions for Use:

- ▶ **1. Before starting the machine**-Before powering on: Please take the machine out of the box and let it stand for 48 hours.
- ▶ **2. Before starting the machine**-Door hinge: interchangeable left and right.
- ▶ **3. In use-Temperature setting:** Please refer to the setting instructions in the manual. The machine can be easily used by setting the target temperature.
- ▶ **4. In use**-There are water droplets on the glass: Do not open the door frequently, because there is a big temperature difference between the temperature inside the machine and the temperature outside the machine. Frequent opening of the door will lead to water droplets on the glass, which is normal and does not affect the use of the product.
- ▶ **5. In use**-The temperature difference between the upper and lower parts of the machine is large: the space inside the machine is large, and the fan will start to circulate the air inside the machine after the machine is turned on, so that the upper and lower temperatures are close.
- ▶ **6. After use**-If you don't use the machine for a long time, please unplug the power supply and store the dust cover for the machine.

If any problems with our commodity, Please feel free to contact us  
Please provide your purchase order number when contacting.

Email: [support@vushineshop.com](mailto:support@vushineshop.com)



## TABLE OF CONTENTS

● Product Structure .....	7
● Product safety precautions .....	8
● Product Installation Guide .....	14
● Display board operation guide .....	25
● Troubleshooting Guide .....	38
● Warranty Statement .....	39

## Structure of Constant Temperature Product

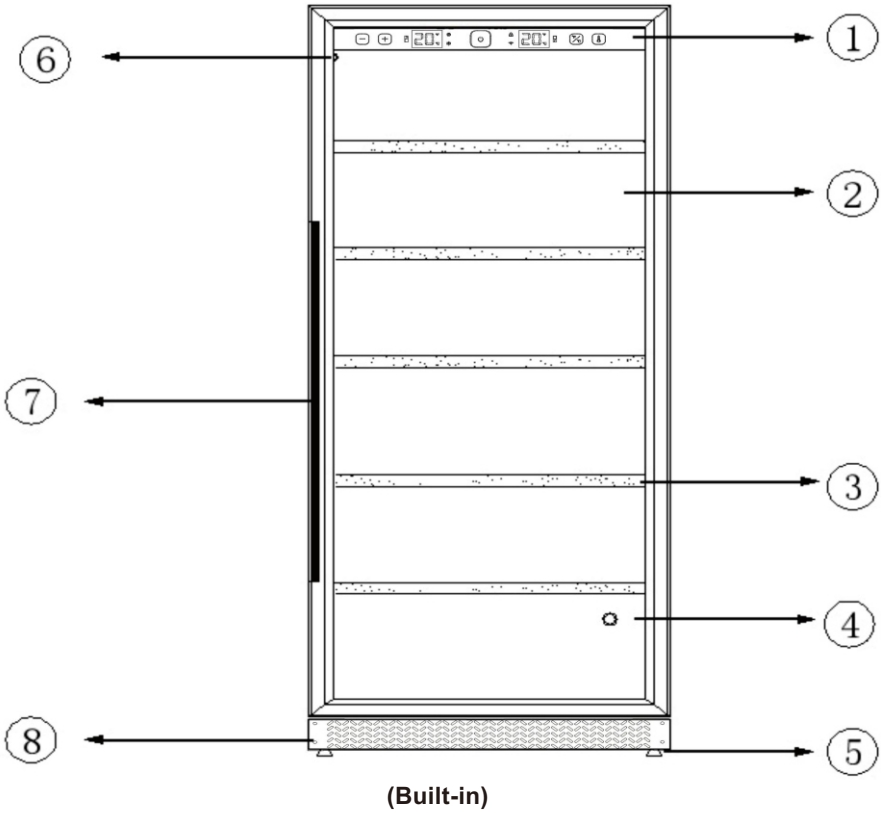

- ① Control panel
- ② Cabinet
- ③ Wine layer rack
- ④ Vent hole
- ⑤ Adjustable support legs
- ⑥ Activated carbon filter
- ⑦ Door handle
- ⑧ Ventilation bas

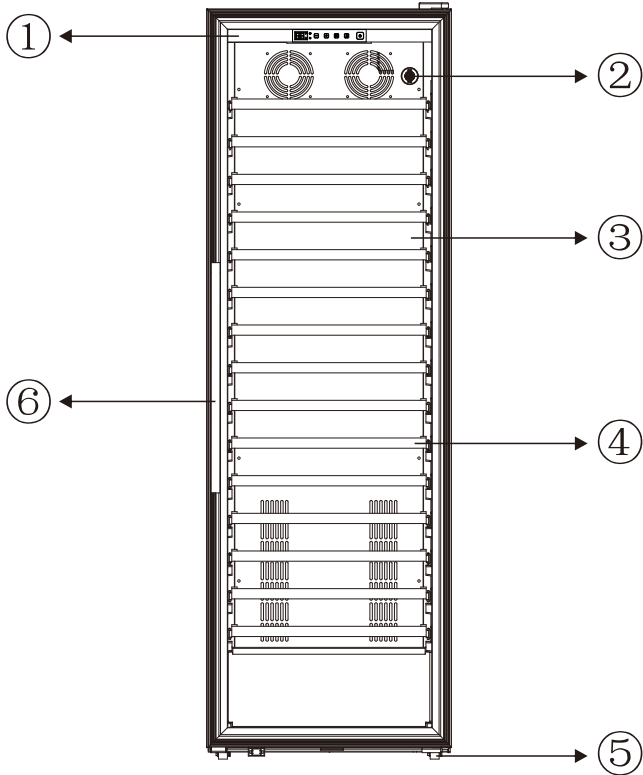

**(Free-standing)**

- ① Control panel
- ② Activated carbon filter
- ③ Cabinet
- ④ Wine layer rack
- ⑤ Adjustable support legs
- ⑥ Door handle

# Warning

**For your safety, please carefully read and follow all the following safety regulations and instructions before use**

---

**The instruction manual is subject to change without prior notice**

Due to safety issues caused by improper operations, our company will not be held responsible. The product warranty service only applies to the product itself and not the stored items.

This product is not suitable for use, cleaning, or maintenance by children under 8 years old, the elderly, individuals with mental disorders, or lack of experience without supervision from adults or supervisors.

Do not let children play with the liquor cabinet.

Do not store acidic foods or items, flammable and explosive materials, etc. in the product.

**■ This product is suitable for household and similar purposes, such as:**

Kitchen areas in shops, or offices, other workplaces;

Customers of farms, hotels, motels, and residential environments;

Family hotel style environment;

The catering industry and similar non retail applications.

## **Danger: Children at risk of being trapped**

Before you throw away the old product:

● Remove the door;

Place the shelves properly to prevent children from easily climbing in;

Please only handle this device at authorized waste disposal centers.

## R600a Precautions

**For your safety, please follow the following recommendations**

- This device contains a small amount of environmentally friendly and flammable R600a refrigerant. R600a is a flammable and explosive refrigerant that does not damage the ozone layer or cause greenhouse effect. Maintenance personnel should wear personal protective equipment such as protective clothing, gloves, and goggles before maintenance, and ensure good ventilation in the maintenance environment to avoid accidents caused by sparks, open flames, etc.
- During transportation and installation, do not damage the piping devices of the refrigerant system.
- Do not use or manipulate sharp objects on the device.
- Refrigerant leakage may cause eye injury.
- In the event of any accident, the power supply of the equipment should be immediately cut off, and contact with open flames and objects that can generate sparks should be avoided.
- It only takes a few minutes for the air inside the product to circulate completely.
- If there are any needs or suggestions, please notify customer service.
- The space for placing the product must ensure that every 8g of refrigerant requires at least 1m<sup>3</sup> of space, and the refrigerant content of the equipment is listed on the label.

**In order to avoid danger, non authorized personnel or personnel holding professional licenses from the original factory are not allowed to repair or replace the product.**

- Reminder: Please keep the ventilation openings open for external devices or internal structures of the equipment.
- Reminder: Please use the factory recommended defrosting device and do not use other tools for defrosting.
- Reminder: Do not damage the refrigerant pipeline.
- Reminder: Do not use other electrical appliances inside the product.

- Reminder:  This sign is a warning indicating that the refrigerant is flammable.
- Reminder: There is a risk of fire/flammable materials.
- Reminder: Do not store explosive substances such as aerosol cans containing flammable propellants in this device.
- Reminder: When placing appliances, make sure that the power cord is not stuck or damaged.
- Reminder: Do not place multiple portable sockets or power sources behind the device.
- Reminder: Refrigerants are flammable gases. When disposing of equipment, it must be done at an authorized waste disposal center. Do not expose yourself to flames.

**48 hours before using the product, we recommend that you open the cabinet door to remove any residual odors inside**

**Important information on precautions before using the product All models without front air vents are free to place. (Please refer to the technical drawings for details)**

**recommend:**

Choose an excellent location for your product:

A ventilated and unobstructed location;

- Keep away from heat sources and avoid direct sunlight;
- Stay away from damp environments (laundry rooms, bathrooms, etc.);
- Placed on a flat floor;
- Use national standard sockets and avoid using multifunctional sockets or extension cords;
- Please use a power socket with protective devices;

- Please stay away from microwave ovens (some microwave ovens do not have electromagnetic wave protection, and placing them one meter away from the product may affect its normal operation)

## Grounding Installation Guide

When installing the product, it is necessary to connect the grounding wire. Please use the grounding power socket correctly to prevent wire leakage and reduce the risk of electric shock; The product is equipped with a grounded power cord. Incorrect grounding installation may result in electric shock. If you have any questions about grounding installation information, please consult a qualified electrician or maintenance personnel.

**Attention: If there are frequent lightning strikes in the area, it is recommended to use a power protector.**

### Precautions for Installing Product

Open the packaging and remove all safety protection fillers from the product. Please install the product in a location where the power outlet is accessible and the compressor cannot be touched by your body.

Adjust the height of the product: When adjusting the height of the product, do not place any items inside the box.

The product comes with four adjustable legs, making it easy to adjust the height of the cabinet. We suggest that you adjust the height of the rear two legs to the maximum, and then adjust the front two legs to achieve balance.

**To avoid fire, electric shock, and any accidental injury during use, please pay attention to the following preventive knowledge.**

- Be aware of the danger of children being trapped inside the liquor cabinet.
- Do not allow children to operate and use the product alone.
- Do not store flammable materials in the product and keep them away

from any flammable materials.

- Please do not place any electrical appliances or heavy items on the top of the product.
- To prevent damage to the door seal, make sure the door is fully open when removing the shelf from the product.
- Unplug the power cord and secure the product before moving it.
- When placing the bottle, please do not move the box, as this may cause deformation of the box.
- The product should be installed in a suitable location to avoid touching the compressor with hands.
- The product should be placed in a properly ventilated area for easy heat dissipation.
- If the power cord or product lighting is damaged, to avoid danger, it is prohibited to use it with electricity and must be replaced by professionals from the manufacturer, their maintenance department, or similar departments.
- If the power cord is damaged, to avoid danger, it is prohibited to use it with electricity.
- Embedded installation machine, clear surrounding obstacles and maintain air circulation.
- If you want to dispose of the product, please do the following: remove the glass door of the product, and remove the wine shelf to prevent children from climbing.

### **Safety precautions**

- Before using the product, all packaging must be removed to avoid poor grounding or increased noise. To ensure the stability of the product, please adjust the feet according to the placement on the ground.
- The design of the product is upright, and sufficient ventilation should be maintained at the back of the cabinet to facilitate heat dissipation when placed.

- Be sure to use a separate three core power socket with a grounding wire.
- Avoid squeezing, folding, knotting or damaging the power cord. If the power cord is accidentally damaged during transportation or installation, please contact the customer service department immediately. The product can only be powered on after replacing the power cord, otherwise it may cause electric shock or even fire.
- Children should be taken care of to ensure that they do not play with the liquor cabinet. Also, do not let anyone climb, sit, stand, or lean against the door or container of the product.
- When repairing or cleaning the product, the power plug must be unplugged. When unplugging the power plug, do not directly pull the power cord to prevent it from breaking.
- It is prohibited to place flammable and explosive materials such as alcohol, gasoline, etc. in the liquor cabinet to prevent explosions and fires.
- Do not damage the refrigeration pipeline. If refrigerant in the pipeline splashes into the eyes, it can cause serious injury.
- When the product is scrapped, please remove the door seal to avoid accidents caused by children entering and playing.
- Due to the use of combustible refrigerants and combustible insulation foam materials in the product, damage to the refrigeration pipes should be avoided when scrapping the product; Keep away from sources of ignition and entrust to a qualified recycling company for disposal.
- Do not use flammable sprays near the product.
- Do not damage the refrigeration pipeline. If refrigerant in the pipeline splashes into the eyes, it can cause serious injury.
- It is prohibited to use electrical appliances inside the box, and it is not advisable to place or use microwave ovens, rice cookers, voltage stabilizers, and other electrical devices on the top of the product.
- In the outer shell or embedded structure of the product, it is necessary to maintain smooth ventilation and no obstacles.

- Do not clean the product with flammable liquids, as flammable liquids and their vapors can cause fire hazards and explosions.
- To prevent your child from being locked up in the product, please do not allow them to use, play with, or climb inside the cabinet; If the product is no longer in use, please remove the glass door to prevent children from closing it inside
- Warning: Do not use mechanical equipment or other methods to accelerate the defrosting process except as recommended by the manufacturer.

## Product Installation Guide

### Open and clean the product:

Remove the external and internal packaging materials.

Before connecting the device to the power source, let it stand upright for about 48 hours, which helps reduce the possibility of handling cooling system failures during transportation.

Clean the inner surface with a soft cloth and warm water.

### Handle assembly:

According to the actual situation of the product, if the Product needs to install the door handle themselves, please follow the following steps to install the door handle:

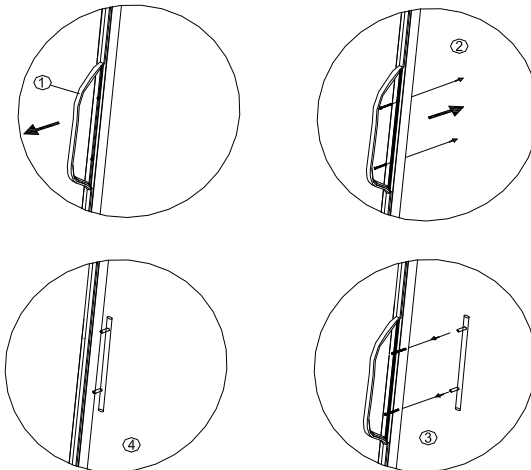

- Step1** Open the door seal at the location where the handle needs to be installed
- Step2** Install the handle screw at the corresponding position specified in the diagram
- Step3** Use a Phillips screwdriver to fasten the door handle onto the door body
- Step4** Seal the door back to the corresponding position of the door body

### Door safety lock (optional)

Locking is an optional feature. If your product has this function, a key should be included in the packaging of this manual.

Insert the key into the lock and turn counterclockwise to unlock the door. Please lock it and perform the opposite operation.

Please keep the key safe.

### ACTIVATED CARBON FILTRATION SYSTEM

Your wine is a living organism that breathes through the cork of the bottle. In order to maintain the quality and taste of high-quality wines, they must be stored under ideal temperature and environmental conditions. Your product is equipped with an activated carbon filtration system to ensure air purity, cooling efficiency, and maintain an odorless cabinet for storing your high-quality wine. The filter component is located on the back panel inside the wine cellar.

Please remember that this filter suggestion be replaced every 12 months.

To replace the filter:

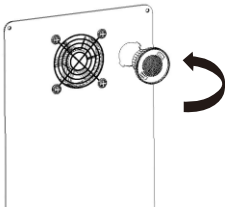
1	Take out the wine stored on the two shelves in front of the filter.	 <p data-bbox="607 1300 888 1385">Turn counterclockwise to remove, clockwise to tighten</p>
2	After replacing the filter, remove the shelf and set it aside for replacement	
3	Grasp the filter and rotate it counterclockwise by 45 degrees, then pull it out.	
4	Remove the existing filter and replace it with a new one.	
5	Insert the new filter into the hole and rotate it clockwise by 45 degrees.	

(1) After opening the packaging box of the product, please carefully inspect the cabinet for any abnormal conditions such as damage or deformation;

(2) Check the cabinet door to see if the components inside the cabinet are complete, such as shelves, manuals, keys, etc; If there are shelves or support shelves that drop during transportation, please install them according to the relevant items on the following page.

(3) If there are no issues with the product after inspection, place it in the designated location. Attention should be paid to the following when placing:

a、 The distance between the product and the left and right walls should be at least 2 inch ; The distance between the back of the product and the wall should be at least 3.2 inch. As shown in the following figure (unit: inch)

b、 The ground on which the product is placed must be flat. If it is not level, the four support feet at the bottom of the product can be adjusted to keep the cabinet level.

C、 The location of the product must be away from all heat sources and not near laundry rooms, bathrooms, etc.

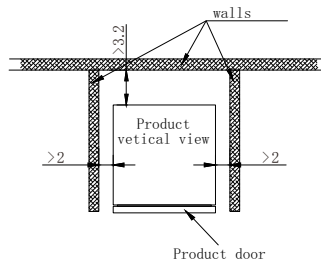

(4) The inclination of the product during transportation should not exceed 45 degrees, and it must be powered on and operated at least 48 hours after transportation.

(5) If the product needs to be placed in the workbench, it is necessary to ensure that the ventilation behind the product is smooth, otherwise it will reduce the effectiveness of the product.

## **Power connection**

### **Models (JCS-58QYL/JCS-58QE/JCS-408QE/JCD-508QE) can be used with or without embedding**

1. The embedded product adopts a bottom ventilation design
2. When installing embedded products, please follow the product installation diagram and ensure that the minimum installation size is not smaller than the product installation diagram, otherwise it will affect the ventilation of the product.
3. The embedded product control panel is equipped with a power switch, so it is not affected by the position of the power cord connection.
4. This product adopts standard 110-120V/20A/50Hz~60Hz; Power connection (or according to different national specifications).
5. The power cord length of this product is 70.86inch and is installed at the bottom of our front product (see embedded installation diagram for details).
6. Like most electrical appliances today, this product contains sensitive electronic components that are susceptible to damage from lightning and power supply errors. Therefore, it is recommended to use a surge protection device to avoid such natural damage.

A ventilation opening or grille must be left at the top of the rear, and ventilation fans should be added to ensure that air enters the back of the product .

- This vent or grille should not be opened on the same side as other devices such as ovens or in a closed area where air cannot enter. Violation of the above specifications will result in the invalidation of the warranty. If air cannot enter due to improper operation or placement, resulting in equipment problems, the warranty service will not be available.

### Schematic diagram of embedded device

Model: JCS-58QE / JCS-58QYL

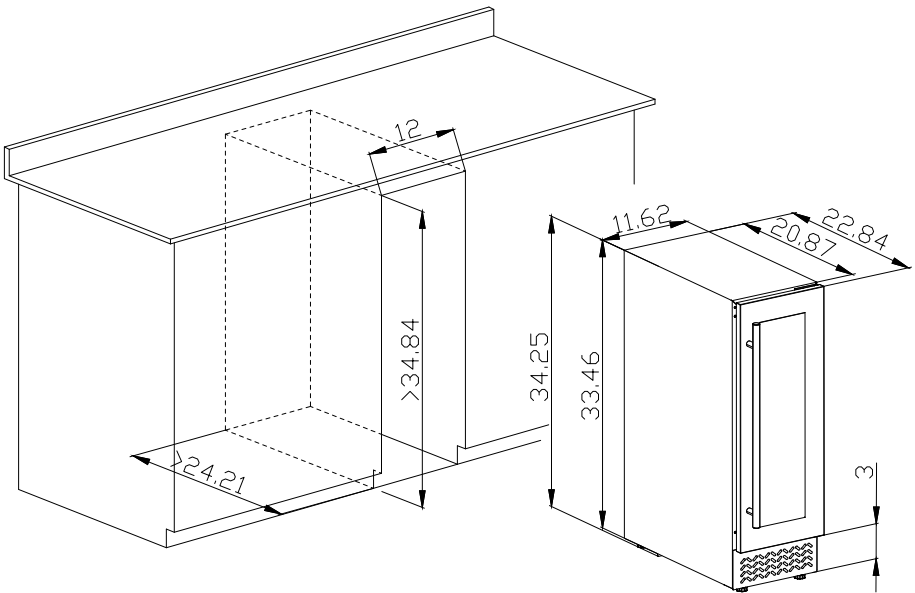

(Unit: Inch)

JCS-408QE

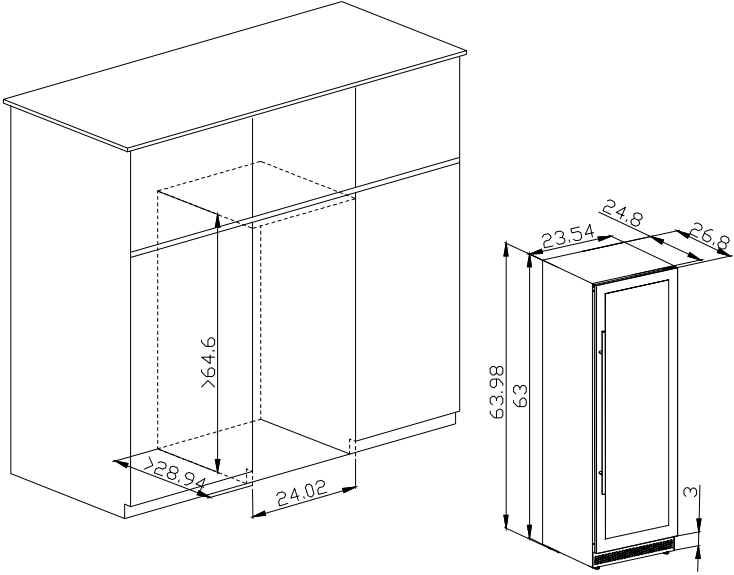

JCS-508QE / JCD-508QE

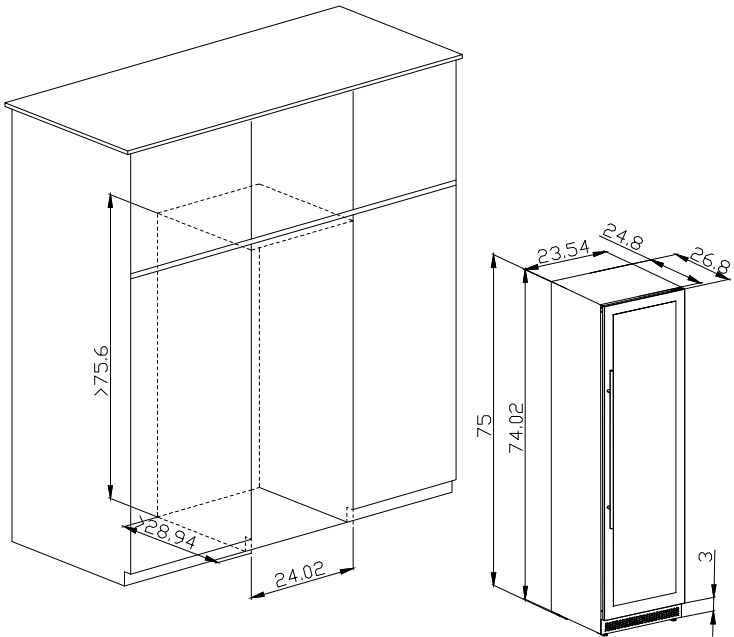

(Unit: Inch)

## Schematic diagram of door opening direction exchange

This device has the ability to open doors from the left or right side. Open the door from the left and deliver the equipment to you. If you want to reverse the opening direction, please follow the instructions below.

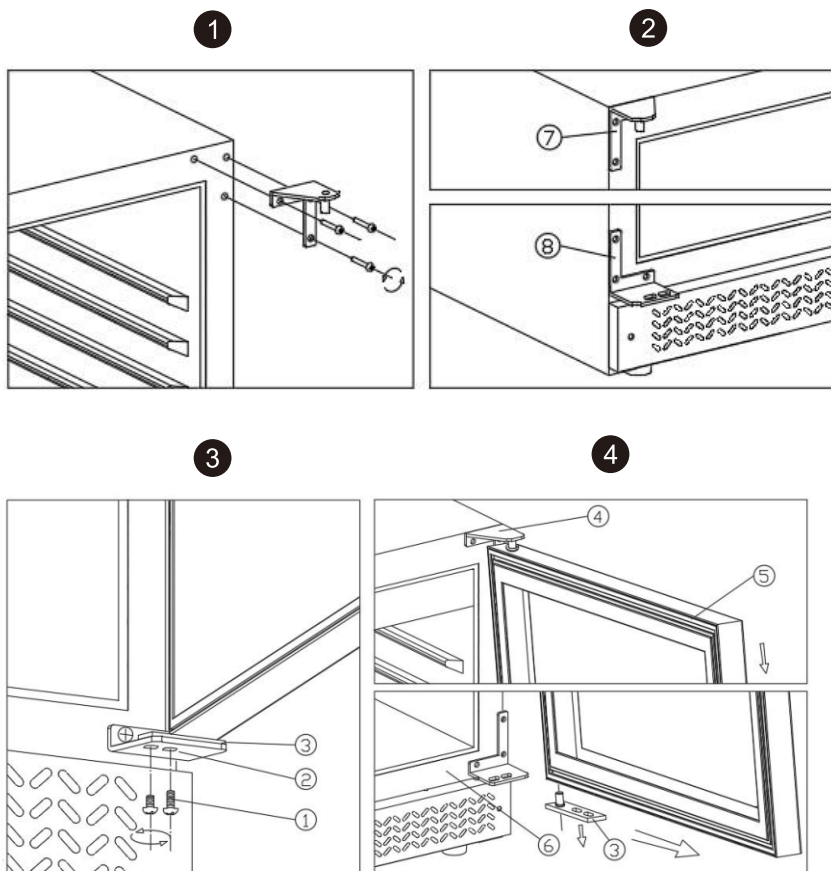

① locking screw ② Lower hinge (right) ③ Door shaft

④ Top hinge (right) ⑤ door ⑥ Cabinet

⑦ Top hinge (left) ⑧ Lower hinge (left)

## Activate your product

When the product is put into use, please plug in the power plug. At this time, the machine will start working according to the product settings.

When you first use the product (or haven't used it for a long time), there may be an error between the displayed temperature and the temperature you set, which is a normal phenomenon. As the machine takes time to start, the product will display normally after running for a few hours.

Reminder: When the device power is interrupted, disconnected, or forced to stop operating, do not start it immediately. Wait for 3 to 5 minutes before restarting.

## ■ Running noise

When the product is in operation, in order to reach the set temperature, our product, like all product that use compressors and fans for cooling, will produce the following types of noise. These noises are normal, and the possible situations that may occur are as follows:

Gollum sound: The reason is the sound made when the refrigerant flows through the circuit.

- Bursting sound: The reason is the sound produced by the contraction and expansion of gas during the cooling of refrigerant
- The sound of the fan: The sound produced when the air inside the product is circulating and the fan is running.
- Personal perception of noise is directly related to the environment in which the product is placed. Our company is a professional product manufacturer, and our products comply with international standards. We will make every effort to meet customer needs, but we will not withdraw product that have complaints based on normal working noise.

## ■ Wine display and storage

When placing wine, it can be divided into single or double portions, and please follow the following precautions: when the amount of wine you place is small, please disperse it in the product to avoid uneven placement of the upper and lower layers. If necessary, the shelves can be removed or readjusted to accommodate large bottles or to accommodate an increase in bottle stacking (please refer to installation information). When displaying and placing, keep a distance from the wall, maintain air circulation, and maintain a constant temperature.



- Do not overload to maintain good air circulation;
- Do not stack more than 1.5 rows of 25.35OZ ( 750ml ) standard bottles on each shelf to ensure air circulation;
- Please avoid placing objects at the fan outlet to prevent air circulation and temperature imbalance;
- Do not slide the shelf after it is fixed to prevent the wine bottle from falling off;
- Avoid pulling out two or more shelves at the same time to prevent the unstable center of gravity of the product from tilting forward;
- Do not lay metal or other materials of foil on the shelf to prevent air circulation;
- To prevent damage to the machine, do not move it while it is filled with wine and beverages.

## ■ Adjustment type

- Based on the loading capacity and settings, it takes approximately 48 hours for the product to achieve temperature stability
- During this period, it is normal for the LCD display of the product to float, product easily occur when adjusting settings and loading a large number of product. When there is a temperature difference in the operating environment of the product, if the temperature is higher or lower than this range, it may affect the

performance of the equipment. If the product is installed in a low-temperature or hot environment, it may cause fluctuations in equipment temperature and fail to reach the ideal temperature.

### ■ Storing wine

- For red wine, it is recommended to set the temperature at 54°F to reach the ideal storage temperature, so as to fully enjoy the ideal drinking experience brought by wine. The temperature of the product can be adjusted by yourself. It is recommended that you set the champagne temperature to 45°F, and the red wine temperature to 54°F. (If there is a special storage temperature, please adjust it by yourself).

### ■ Temperature setting

- Temperature settings are saved. In case of power interruption, all previous temperature settings will be restored to the preset temperature before power failure after power on.
- All models of circuit boards come with memory function.

### ■ Please be informed that:

- There is a slight difference in temperature between the wine and the air inside the product. When the product is fully filled, you need to observe whether the temperature on the monitor changes. Generally, you wait for nearly 12 hours to feel the effect of temperature adjustment.
- After the temperature setting is completed, it is strongly recommended that you do not adjust the temperature setting arbitrarily or frequently, in order to maintain a constant temperature inside the product. The temperature fluctuations of the wine and glass bottles themselves should be controlled between 1°F.



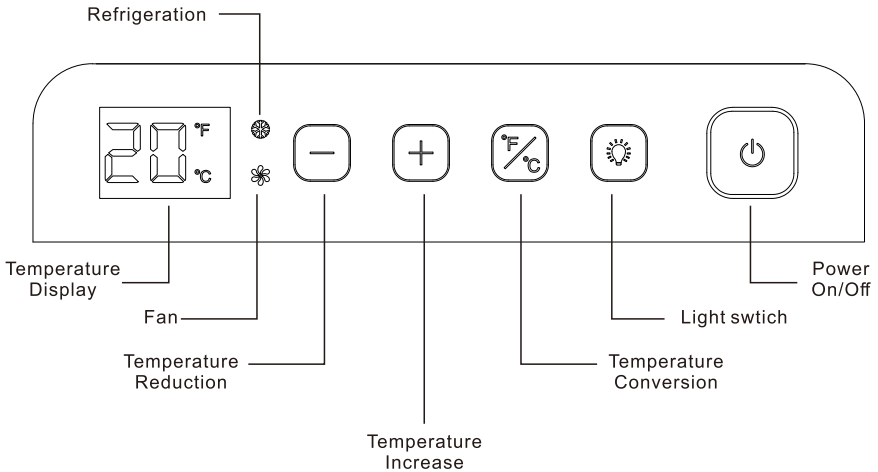

## ■ Display board operation guide

### 1. Single temperature panel layout

Model: JCS-58QYL / JCS-58QE



## ■ Key Description

	<b>Temperature up button</b> Temperature Increase		<b>Temperature conversion key</b> Control temperature unit conversion
	<b>Temperature down button</b> Temperature Reduction		<b>LED Light switch</b> To turn the light on/off
	<b>Power button</b> To turn the machine on/off.		

## 1.1 Room temperature setting

- JCS-58QYL: Temperature setting range 37°F~64°F.  
JCS-58QE: Temperature setting range 41°F~64°F.

### Key functions and operations

#### 1.1.1 Temperature up button

- Pressing this key can increase the set temperature.
- Press this button to flash the original set temperature, and then each time you press it, the temperature will increase by one unit.
- After completing no operation, the actual temperature will be restored and displayed within 5 seconds.

#### 1.2. Temperature down button

- Pressing this key can lower the set temperature.
- Press this button to flash the original set temperature, and then each time you press it, the temperature will decrease by one unit.
- After completing no operation, the actual temperature will be restored and displayed within 5 seconds.

#### 1.3. Temperature conversion key

- Pressing this key can control temperature conversion.
- Press once to cycle between the two modes of °C or °F.



#### 1.4. Power on key

- Pressing this button can open and close the product.
- Press and hold for 3 seconds to close the product; Touch to open the product.

#### 1.5. Light switch key

- Pressing this button can open and close the LED Light.

## 1.6. Screen saver function

- If there are no touch buttons for 120 seconds, enter the screensaver state. Touch any buttons in the screensaver state, exit the screensaver;
- All icons in non screensaver state are lit up at 100%; In screensaver mode, except for the half lit power button  , all other icon lights are off;
- Press the power button  while in screensaver mode to release the screensaver and perform control operation settings normally.

## 1.7. Buzzer

- The buzzer beeps for 1 second each time the power is turned on;
- Short button buzzer beeps briefly once;
- Long button buzzer beeps once;

## 2. Single temperature panel layout (With door switch)

**Door switch: Open/Close the door to control the light ON/OFF**

**Model: JCS-408E / JCS-408QE / JCS-508E / JCS-508QE**

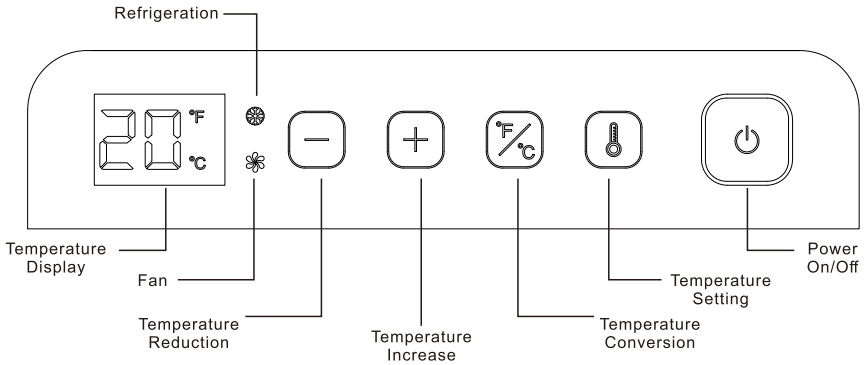

### ■ Key Description





	<b>Temperature up button</b> Temperature Increase		<b>Temperature conversion key</b> Control temperature unit conversion
	<b>Temperature down button</b> Temperature Reduction		<b>Temperature Settings</b>
	<b>Power button</b> To turn the machine on/off.		

## 2.1. Room temperature setting





- Room - Left window 41 °F-64 °F

### Key functions and operations

#### 2.1.1 Temperature up button

- Pressing this  key .
- Pressing  key can increase the set temperature.
- Press this button  to flash the original set temperature, and then each time you press it, the temperature will increase by one unit. Long press this key to continuously increase the temperature.
- After completing no operation, the actual temperature will be restored and displayed within 5 seconds. 

#### 2.2. Temperature down button

- Pressing this  key .
- Pressing  key can lower the set temperature.
- Press this button  to flash the original set temperature, and then each time you press it, the temperature will decrease by one unit. Long press this key to continuously lower the temperature.
- After completing no operation, the actual temperature will be restored and displayed within 5 seconds. 



#### 2.3. Temperature conversion key

- Pressing this key can control temperature conversion.
- Press once to cycle between the two modes of °C or °F.

#### 2.4. Power on key

- Pressing this button can open and close the product.
- Press and hold for 3 seconds to close the product; Touch to open the product.

## 2.5. Screen saver function

- If there are no touch buttons for 120 seconds, enter the screensaver state. Touch any buttons in the screensaver state, exit the screensaver;
- All icons in non screensaver state are lit up at 100%; In screensaver mode, except for the half lit power button  , all other icon lights are off;
- Press the power button  while in screensaver mode to release the screensaver and perform control operation settings normally.

## 2.6. Door switch function

- **2.6.1** Open the door and the LED lighting will be on; All screen lights are on, buttons are activated, all fans on the air duct board inside the box are stopped (PTC heater is running and stopped), displaying normal actual temperature, and the buzzer does not sound; If the door is not closed for 5 minutes, the buzzer will sound an alarm every 2 seconds.  
reminder character every 2 seconds, and the compressor will not stop. Until the rear door is not closed for 10 minutes, the buzzer will sound an alarm every 10 seconds, the display screen.  
seconds, and the compressor will stop. Until the door closing signal is sensed, the buzzer does not sound, the display screen switches to normal temperature display, and all programs run according to the last normal setting logic.
- **2.6.2** Close the door and turn off the LED lighting. The logic executed before opening the door runs normally.

## 2.7. Buzzer

- The buzzer beeps for 1 second each time the power is turned on;
- Short button buzzer beeps briefly once;
- Long button buzzer beeps once;



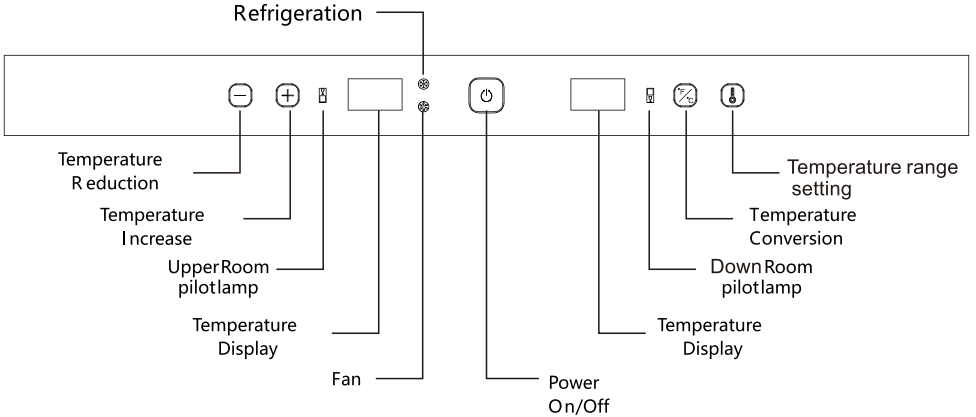

### 3. Dual temperature panel layout

Model: JCD-508QE

**Temperature zone selection:** Press “” key to select upper or lower temperature zone.



#### ■ Key Description

	Temperature up button Temperature Increase		Temperature conversion key Control temperature unit conversion
	Temperature down button Temperature Reduction		Upper and lower temperature zone selection
	Power button To turn the machine on/off.		

### 3.1 Room temperature setting

- Upper room - left window 41~54 °F ; Lower Room - Right Window 54-64 °F

#### Key functions and operations

##### 3.1.1. Room Setting

- Pressing this button allows you to select the set temperature for the upper and lower compartments.
- Press this button, the display screen of the upper compartment will flash, showing the original set temperature of the upper compartment, and the indicator light of the upper compartment  will light up synchronously; Press this button again to jump to the display screen of the lower room flashing and showing the original set temperature of the lower room, and synchronously turn on the indicator light of the lower room.
- After completing no operation, the actual temperature of each room will be restored and displayed within 5 seconds.

##### 3.2. Temperature up button

- After successfully selecting the room in the above step, press this button to increase the set temperature.
- Press this button to flash the original set temperature, and then each time you press it, the temperature will increase by one unit. Long press this key to continuously increase the temperature.
- After completing no operation, the actual temperature will be restored and displayed within 5 seconds.

##### 3.3. Temperature down button

- After successfully selecting the room in the above step, press this button to lower the set temperature.

- Press this button to flash the original set temperature, and then each time you press it, the temperature will decrease by one unit. Long press this key to continuously lower the temperature.
- After completing no operation, the actual temperature will be restored and displayed within 5 seconds.



### 3.4. Temperature conversion key

- Pressing this key can control temperature conversion.
- Press once to cycle between the two modes of °C or °F.

### 3.5. Power on key

- Pressing this button can open and close the product.
- Press and hold for 3 seconds to close the product; Touch to open the product.

### 3.6. Screen saver function

- If there are no touch buttons for 120 seconds, enter the screensaver state. Touch any buttons in the screensaver state, exit the screensaver;
- All icons in non screensaver state are lit up at 100%; In screensaver mode, except for the half lit power button , all other icon lights are off;
- Press the power button  while in screensaver mode to release the screensaver and perform control operation settings normally.

### 3.7. Door switch function

- **3.7.1** Open the door and the LED lighting will be on; All screen lights are on, buttons are activated, all fans on the air duct board inside the box are stopped (PTC heater is running and stopped), displaying normal actual temperature, and the buzzer does not sound; If the door is not closed for 5 minutes, the buzzer will sound an alarm every 2 seconds, and the display screen will show the "OP" reminder character every 2 seconds, and the compressor will not stop. Until the rear door is not closed for 10 minutes, the buzzer will sound an alarm every 10 seconds, the display screen will show the "OP" reminder character every 5 seconds, and the compressor will stop. Until the door closing signal is sensed, the buzzer does not sound, the display screen switches to normal temperature display, and all programs run according to the last normal setting logic.
- **3.7.2** Close the door and turn off the LED lighting. The logic executed before opening the door runs normally.

### 3.8. Buzzer

- The buzzer beeps for 1 second each time the power is turned on;
- Short button buzzer beeps briefly once;
- Long button buzzer beeps once;

## ■ Wine storage temperature gauge

All wines should be stored in a constant temperature environment, with the optimal storage temperature range being between 54°F and 57°F. It is recommended to store all types of wines at the optimal temperature. Please refer to the following information:

Champagne NV, Sparkling, Spumante .....	43°F
Dry White Semillon, Sauvignon Blanc .....	46°F
Champagne Vintage .....	50°F
Dry White Chardonnay .....	50°F
Dry White Gewürztraminer, Riesling, Pinot grigio .....	50°F
Sweet White Sauternes, Barsac, Montbazillac, Ice Wine, Late Harvest .....	50°F
Beaujolais .....	55°F
Sweet White Vintage: Sauternes .....	57°F
White Vintage Chardonnay .....	57°F
Red Pinot Noir, .....	61°F
Red Grenache, Syrah .....	61°F
Red Vintage Pinot Noir .....	64°F
Cabernet & Merlot: French, Australian, New Zealand .....	68°F
Chilean, Italian, Spanish, Californian, Argentinean .....	68°F
Vintage Bordeaux ... Room temperature not exceeding .....	68°F

## ■ Important information about temperature

Our product is professionally designed to provide excellent storage conditions for your wine. Constant temperature is important for long-term storage of wine, with an ideal storage temperature of about 54°F - 57°F. Wine is stored in a natural wine cellar when it leaves the factory, and when you store it, you still store it at the temperature of the natural wine cellar. The temperature of the product (54°F - 57°F) is an excellent environment for wine storage. According to the type of wine, each has its optimal storage temperature (see Wine Storage Temperature Table for details).

Not all wines remain in their best condition even after long-term storage. There are peak periods for wine tasting, with some wines being best tasted for 2-3 years and others for over 50 years still retaining their charm. Please consult your liquor merchant for relevant information.

## ■ Defrosting/Condensation/Humidity/Ventilation

The product is designed with an automatic circulating defrosting system. When the compressor stops, the product automatically defrosts, and the frost water is automatically discharged from the storage area of the product. The condensed water in the container is converted into heat or evaporated by the compressor, and the remaining water is used to maintain the humidity inside the product and the elasticity of natural cork.

### **Be careful:**

The water collected through condensation can be recycled. Under extreme dry environmental conditions, water can be added to the container and placed in the product.

All products are equipped with double edged glass doors with a one-third inner acrylic layer to minimize condensation on the glass doors.

The product is not completely sealed, and fresh air can enter through the drainage pipe. Air circulates inside the product through fans and concave shelves.

### ■ Abnormal operation

Please double check if the door is not closed and confirm if the power is connected. If there is a fuse, please check if it is functioning properly. If your product is faulty, please unplug the power plug and contact the customer service center. If there is a refrigerant circuit fault, please have the original factory professional repair personnel inspect and repair it. Circuit faults on the equipment shall be inspected and repaired by qualified electricians.

Attention: Malfunctions caused by non maintenance by professional technicians from the original factory may result in the failure of warranty services.

### ■ Power failure

In the event of a power outage, the system will automatically save the previous temperature setting and restore it to the preset temperature. (See the preset table for details)

-If the power supply is interrupted within two hours, it will not affect the temperature of the wine. Please do not open the door when the power supply is interrupted to avoid sudden temperature changes and affect the quality of the wine. If you notice any abnormal temperature and humidity inside the product, please do not panic.

But if the above situation occurs for a long time and frequently, it may cause changes in the quality of your wine. Please take other protective measures.

### ■ Troubleshooting Guide

To save your maintenance costs, if you encounter the following common problems, you can refer to the instructions for handling. Please carefully read the applicable manual

# Fault Phenomenon

problem	reason
The product is not functioning	Unplugged power cord The device is in a closed state Circuit breaker tripped or fuse broken
The temperature is not cold enough	Please check the temperature settings Set lower temperature Opening the door too frequently The door is not fully closed The door seal is not completely sealed
Frequently activated	The temperature inside the product is higher than usual Product storage overload The door frequently opens The door is not fully closed Incorrect temperature setting The door seal is not completely sealed
The light is not bright	Unplugged power cord The circuit breaker tripped and the fuse burned out Lamp damage The light is not turned on
Shake and vibrate	Please check and confirm if the product is on a level surface
The product is making noise	Gaga noise may come from the flow of coolant, it is normal. When each refrigeration cycle stops, the cooling gas flowing inside the product may make a gurgling sound. The contraction and expansion of the inner wall may produce a cracking sound. The product was not placed horizontally
The door cannot be completely closed	The product was not placed horizontally The door is upside down and not installed correctly Door seal defects (damaged magnets or rubber) Improper placement of shelves

If the malfunctions still exist, please don't hesitate to contact customer service [support@vushineshop.com](mailto:support@vushineshop.com) for help.

## Warranty and Service

If you have an issue with an our product, please contact us at [support@vushinешop.com](mailto:support@vushinешop.com) , and we will do our best to resolve it for you.



### Support Hours

24 Hours available

\*Please have your order number before contacting customer support.

<http://www.vushinешop.com>

#### Product Certification

The product is approved to leave the factory after passing the inspection.

Production date: see the nameplate or barcode of the fuselage



This manual is applicable to all types of products produced by our company. Perhaps the components you have selected are slightly different from the models in this manual, but it does not affect the normal use of the product. Please carefully read the product instructions related to the model you have selected, and keep this user manual safe for reference in case of any problems.