

# ASSEMBLY INSTRUCTIONS

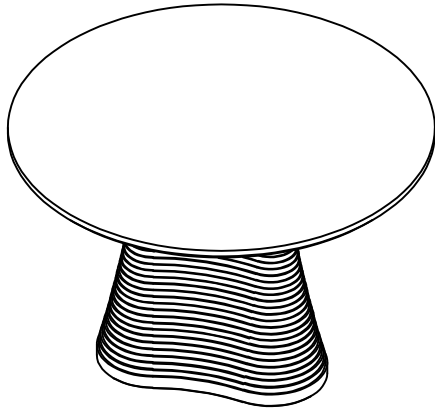

## +Parts Included

① Bottom base (1 pc)

② Connective panel (1 pc)

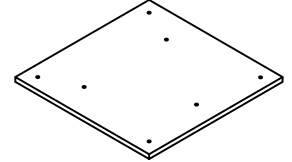
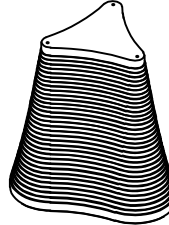

③ Top panel (1 pc)

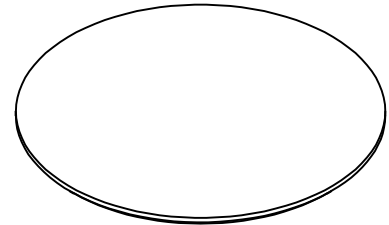

## +Do Not Use Power Tools



## +Suggested Adults

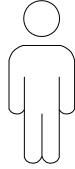

## NOTE:

- 1 Read instructions cover to cover.
- 2 Save all packaging until assembly is completed.

## 1 IMPORTANT SAFETY INFORMATION

- Do not** assemble the product if the parts arrived damaged.
- Do not** assemble if Hardware parts are missing.

## 2 IMPORTANT ASSEMBLY INFORMATION

Assembly Step If loosening persists, please make sure to tighten all the bolts periodically, or use a thread locker adhesive.

## +Parts Included

A. Bolt  
Ø8x40mm (7 pcs)

B. Spring Washer  
Ø8xØ13mm (7 pcs)

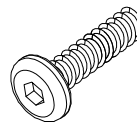

C. Flat Washer  
Ø8xØ19mm (7 pcs)

D. Allen Key (1 pc)

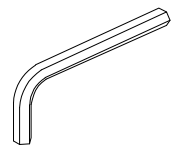

# ASSEMBLY INSTRUCTIONS

①

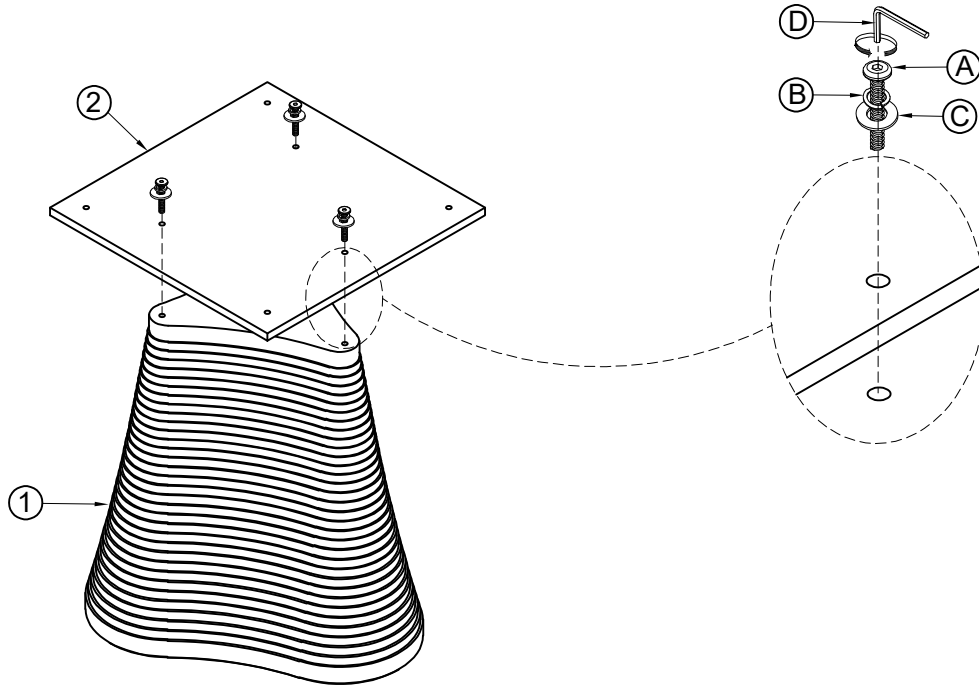

②

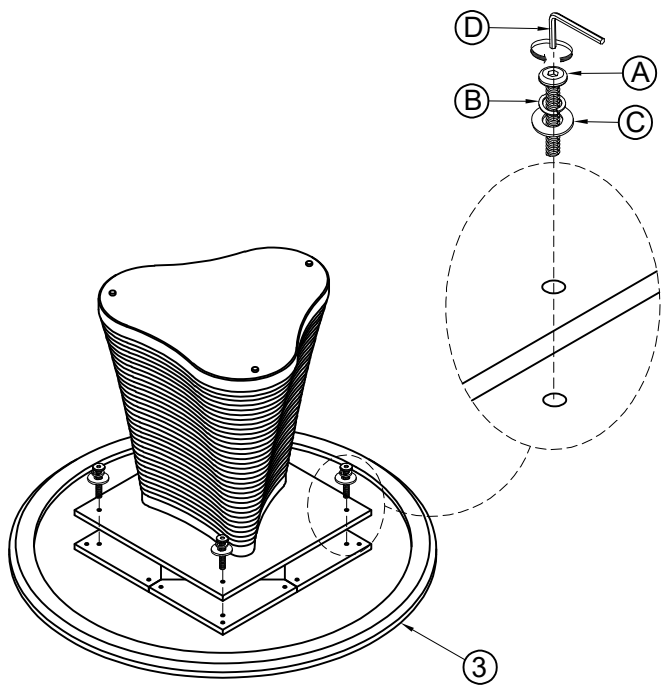

③

