

Assembly Instructions

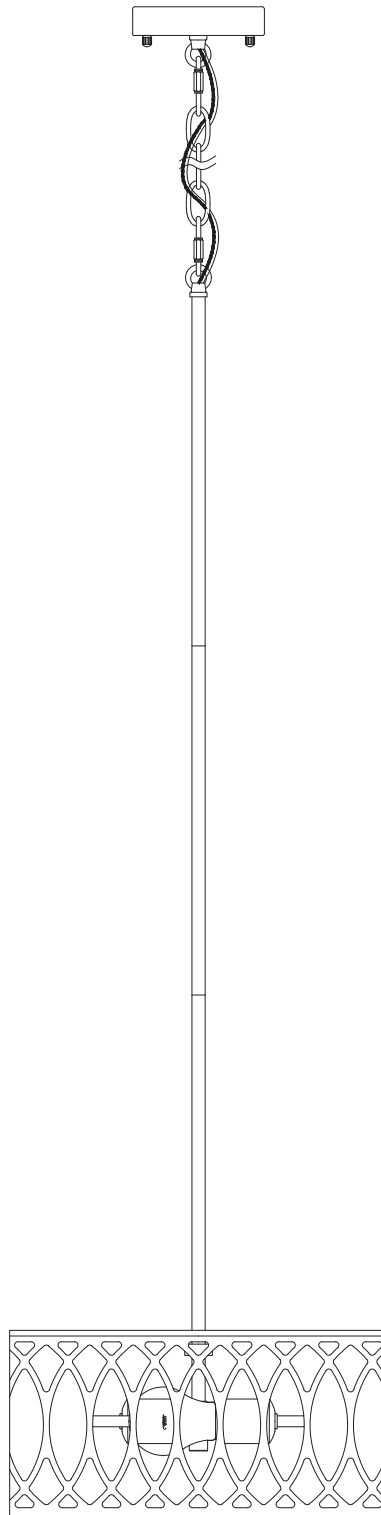

PENDANT

Model No.

THCL-TD0029/ THCL-TD0030

Contact Us

We're here to help you.

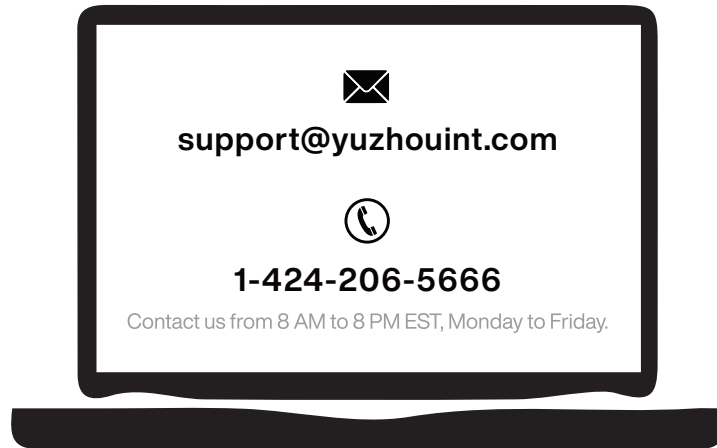

Your satisfaction is our top priority. If you encounter any issues with this product, such as missing or damaged parts, we're here to help. Please retain the original packaging and take photos of the packaging and the product, then contact us as soon as possible.

Warm Tips

1. Carefully read these instructions and keep them for future reference.
2. Check the parts list and confirm everything's there before starting assembly.
3. When assembling, put all parts on a soft, smooth surface like a carpet to avoid scratches.
4. Don't fully tighten screws until all parts are confirmed in place to avoid misalignment.

Pre-Installation

PLANNING INSTALLATION

Read all instructions before assembly. Before starting installation of this fixture or removal of a previous fixture, disconnect the power by turning off the circuit breaker or by removing the fuse at the fuse box. To avoid damaging this product, assemble it on a soft, non-abrasive surface, such as carpet or cardboard.

 **NOTE:** Keep your receipt and these instructions for proof of purchase.

HARDWARE INCLUDED

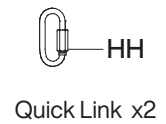
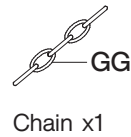
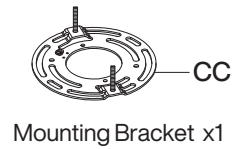
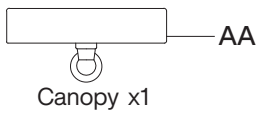

PACKAGE CONTENTS

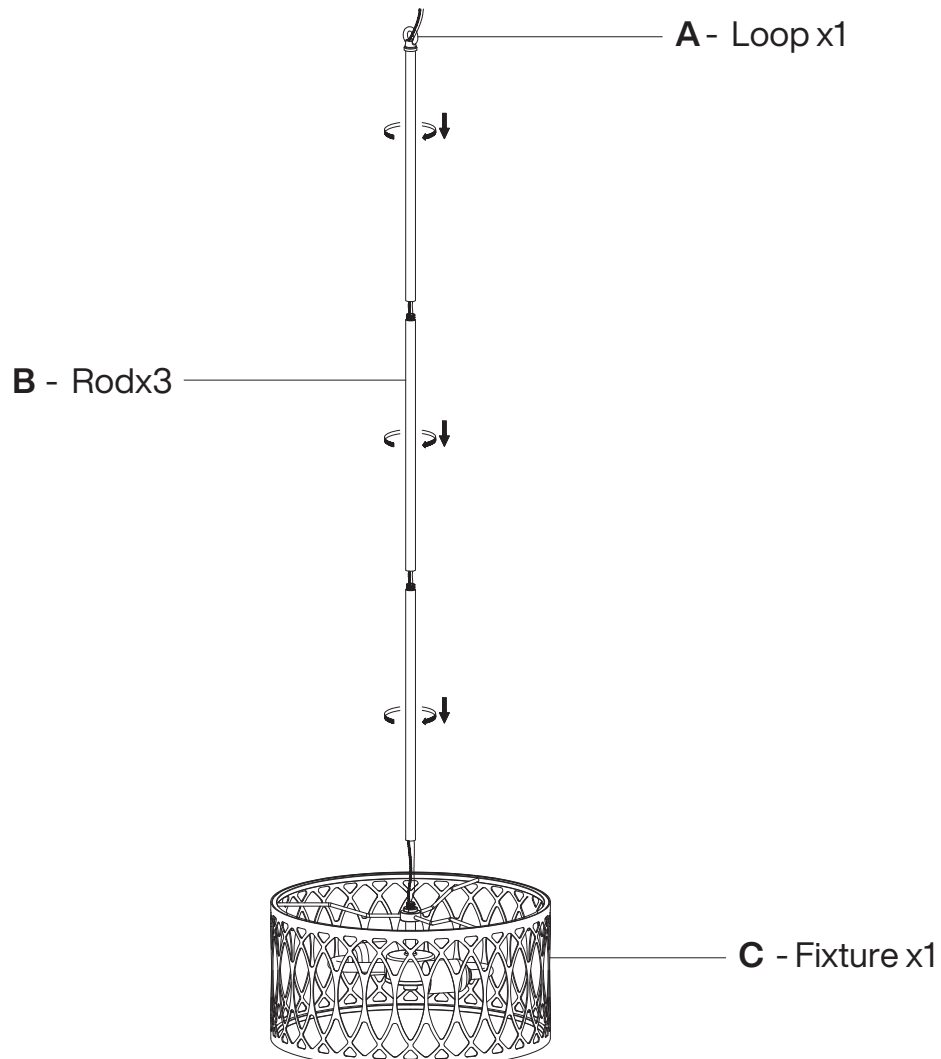

Installation

1 Securing the rods

- Securing the rods (B), depending on desired height to chose Rods then securing loop onto the rod.

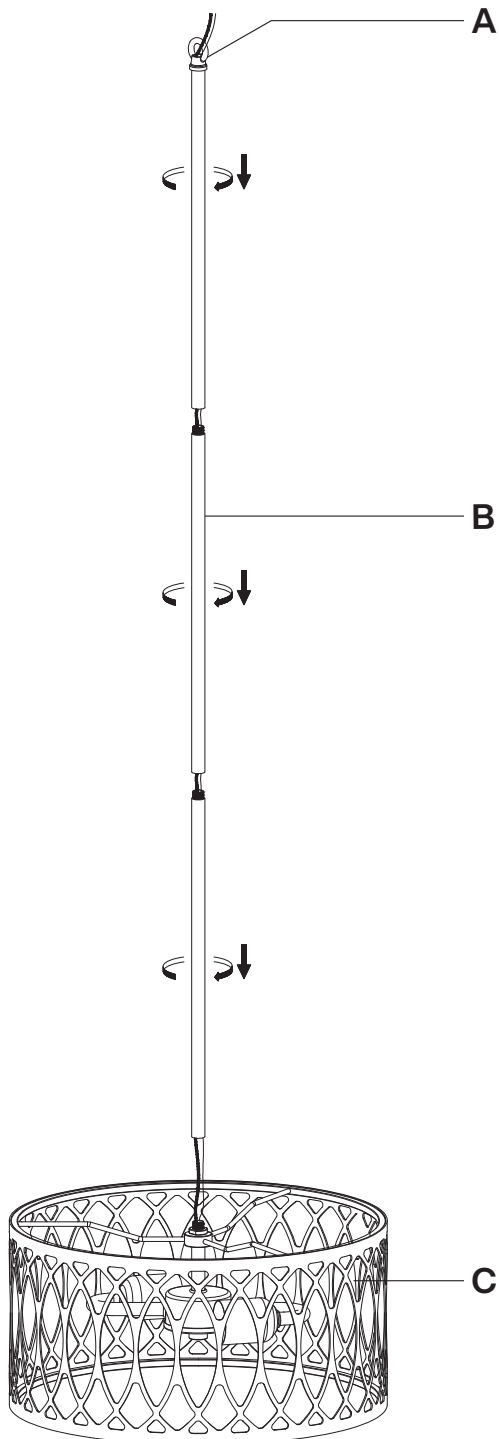

2 Attaching the mounting strap to the outlet box

- Mount the mounting bracket (CC) to the outlet box by using two outlet box screws (EE).
- Make sure the threads of the mounting screws are facing out when the mounting bracket (CC) is attached to the outlet box.

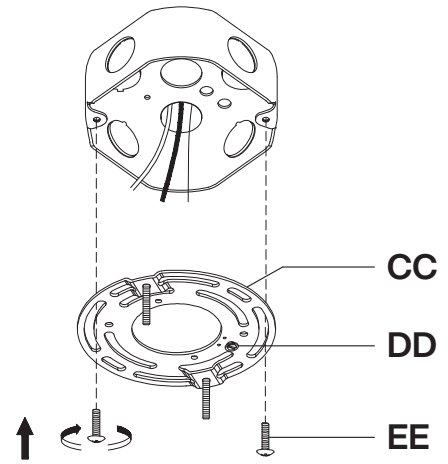

3 Determining the correct length of chain

- Unscrew the quick link (HH) from collar loop (A).
- If necessary, use pliers (not included) to spread links of chain (GG) apart and remove any links to achieve desired hanging height.
- Once chain (GG) is at desired length, unscrew the quick link (HH) on chain (GG), but do not remove.
- Thread collar quick link (HH) and canopy (AA) down chain (GG), then attach the quick link (HH) to the screw collar loop (A) and the bottom quick link (HH) to the fixture loop (A).

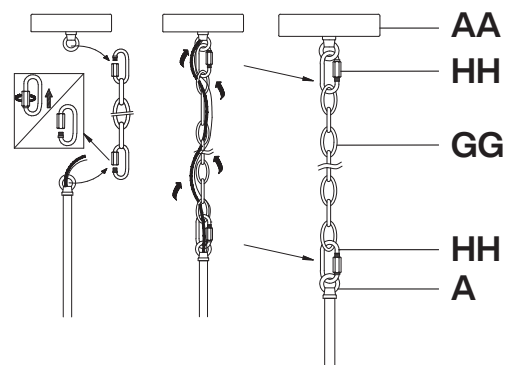

Installation

4 Making the electrical connections

- Adjust the length of the chain (GG), if necessary, use pliers (not included) to spread links of chain (GG) apart and remove any links to achieve desired hanging height.
- Connect the chain to the fixture loop (A) and canopy loop (AA) by quick link (HH).

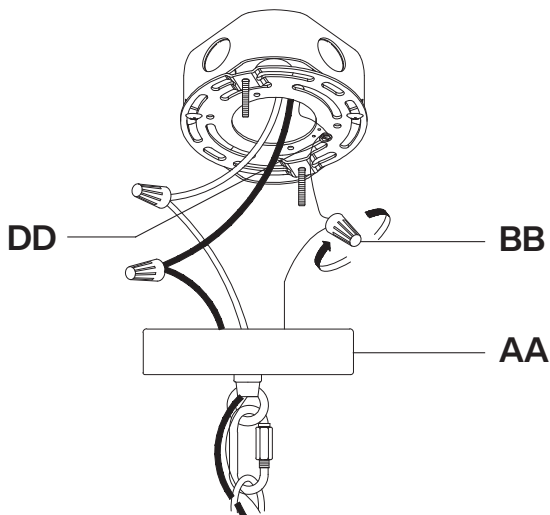

5 Securing the canopy

- Place the canopy (AA) over the outlet box. Align the mounting screws so that they protrude through the appropriate holes on the canopy (AA). Screw the lock nuts (FF) onto the mounting screws.

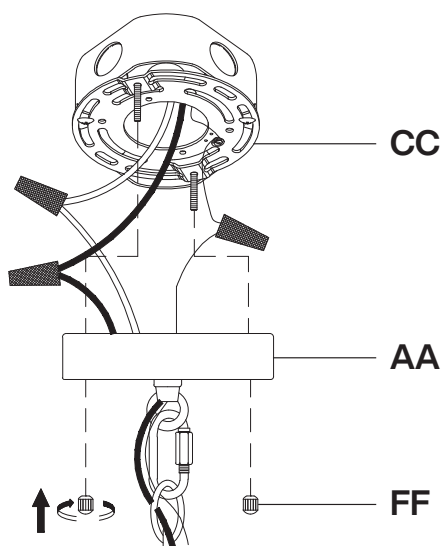

6 Installing Bulbs

- Install light bulbs (not included). Use 60-watt max. standard-base incandescent bulbs.

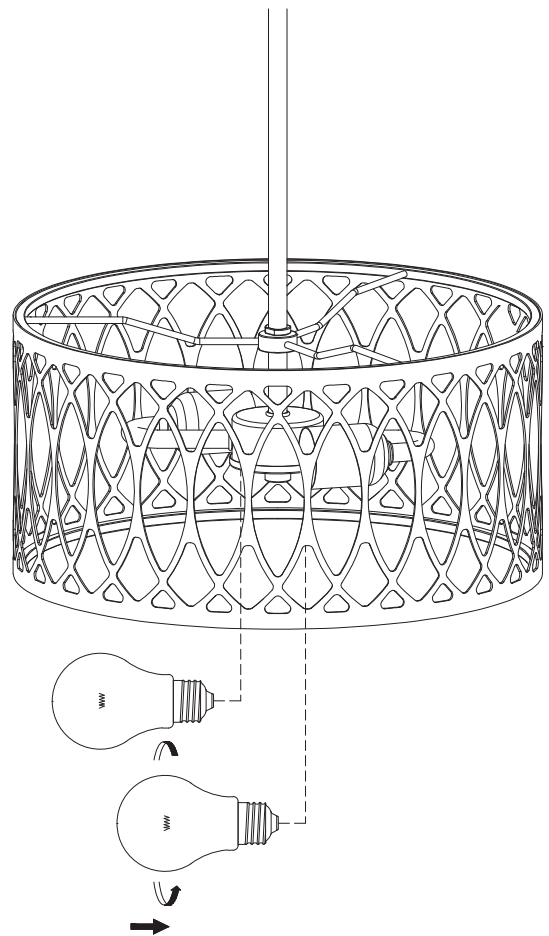

Thank you for your support!

