

ASSEMBLY INSTRUCTIONS

Sofa

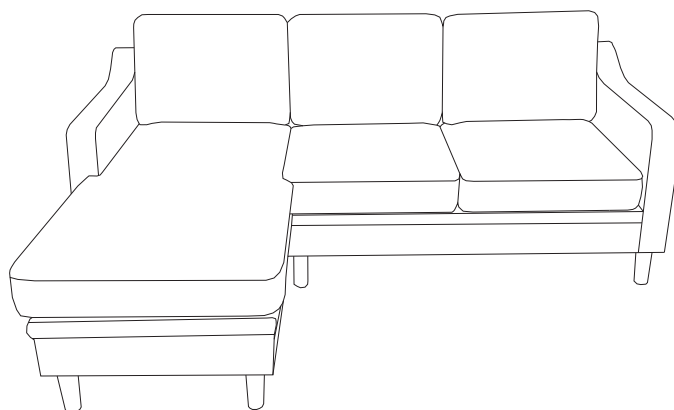

TIME

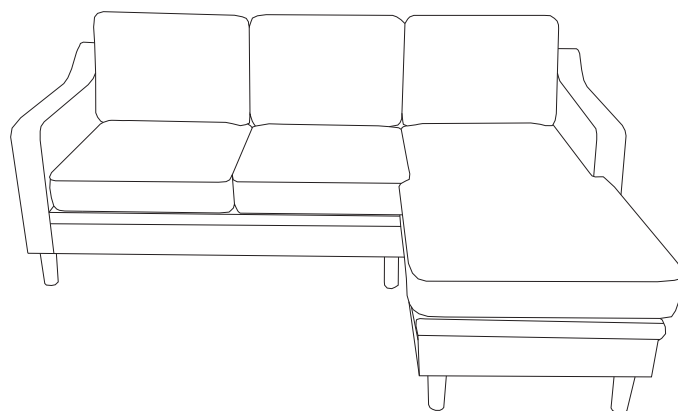

2 OF PEOPLE



DIFFICULTY

NOTICE

Instruction Booklet - Important Safety Information

Thank you for choosing our product. Please review this booklet carefully for essential safety information and keep it for future reference.

- Upon receiving the product, ***ensure all parts are present and intact*** before proceeding with installation. Follow the entire installation instructions provided.
- During installation, exercise caution and refrain from immediately tightening screws. Secure all screws to 80% before final tightening.

Returns are accepted only for items in their ***original, unopened condition***.



Before installation, please check that the parts are all included !

Carton

Materials

BOXA

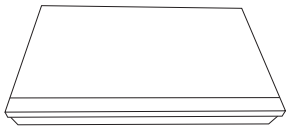

A*1

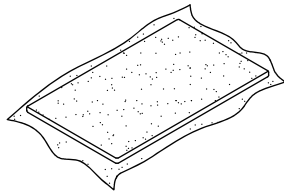

B*2

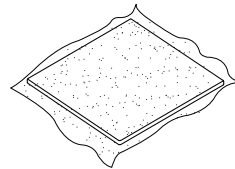

G*1

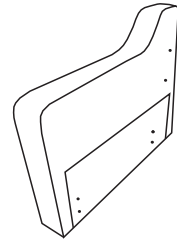

E*1

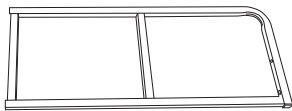

H*2



I*2

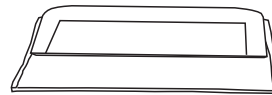

J*1



K*4

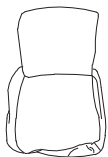

L*2



M*1



M8x60

O*12

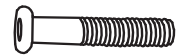

M8x80

P*1

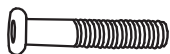

M8x90

Q*4



R*22



S*5



T*1

Carton

Materials

BOX B

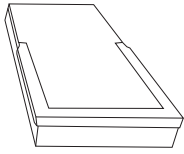

C*1

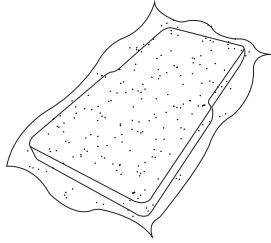

D*1

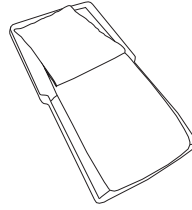

N*1

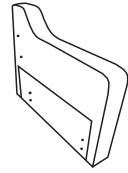

F*1

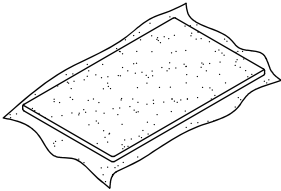

G*2



K*5



M*2

Installation Steps

Materials

STEP1

Assemble the left armrest.

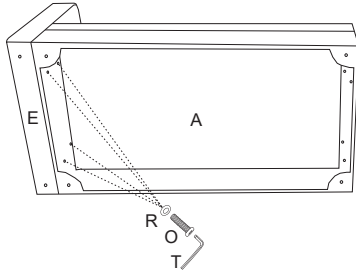

or

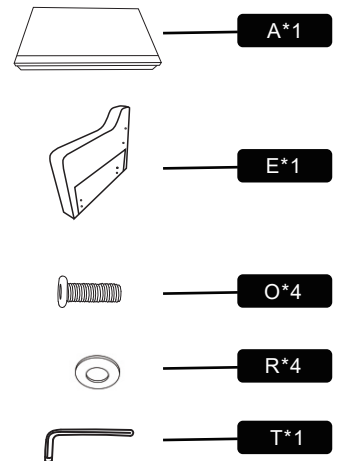
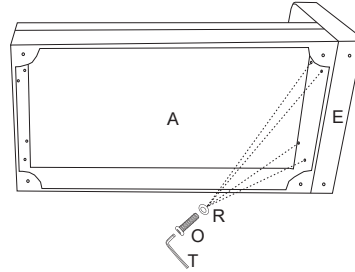

The handrail does not need to be locked for the time being, otherwise the iron back frame behind it is inconvenient to install.

STEP2

Assemble the right armrest.

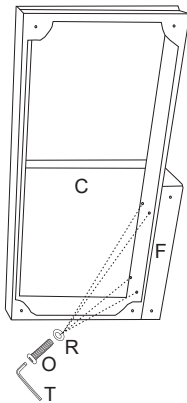

or

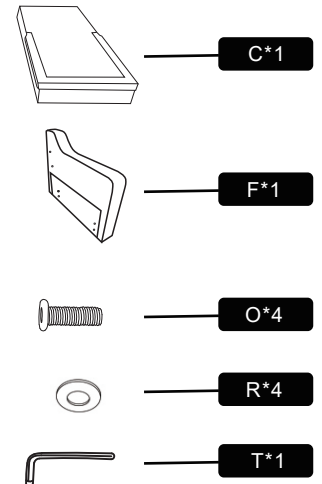
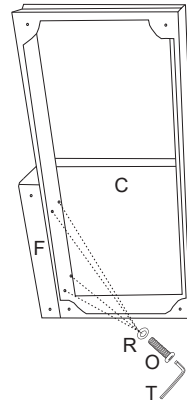

The handrail does not need to be locked for the time being, otherwise the iron back frame behind it is inconvenient to install.

STEP3

Connect the seated frame.

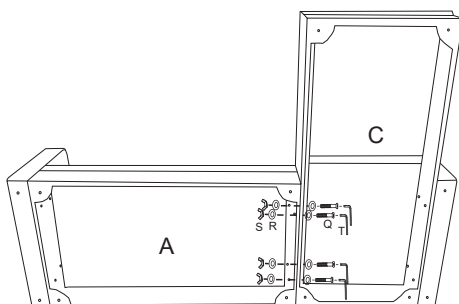

or

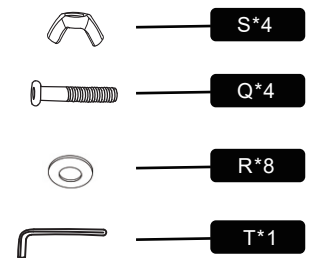
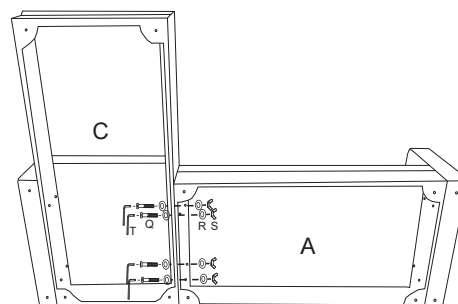

Installation Steps

Materials ▾

STEP4

Assemble the feet. Just rotate and twist your foot inwards.

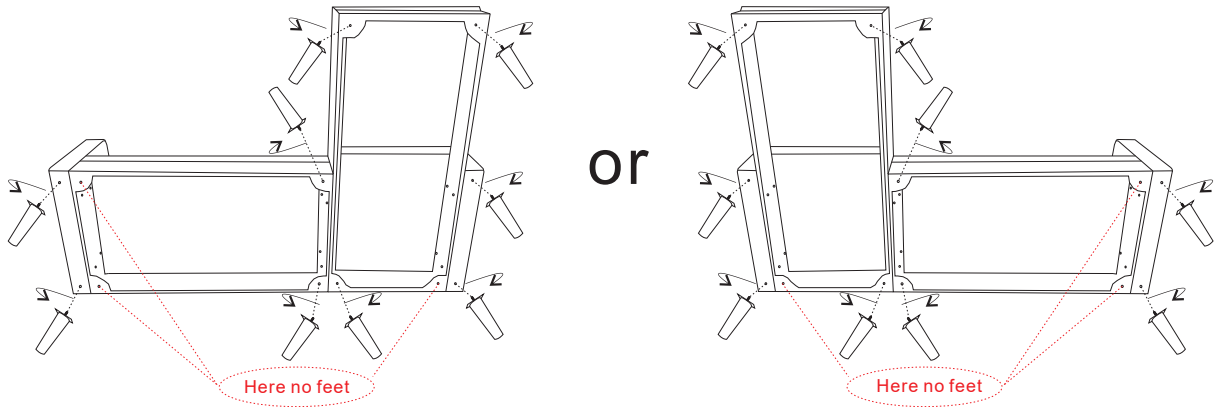
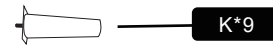

STEP5

Attach the iron back frame.

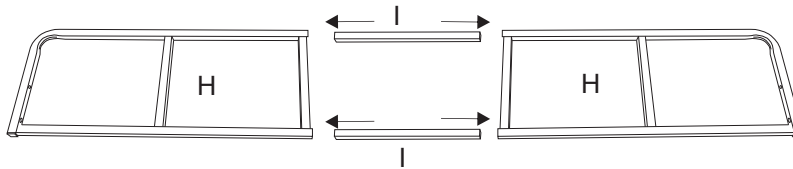
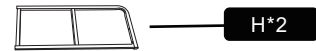

STEP6

The hole is fixed with screws.

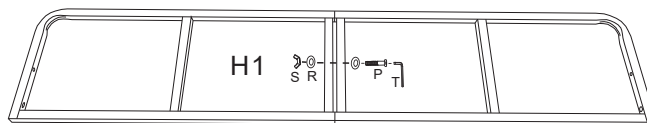
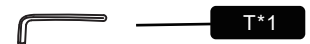
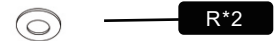
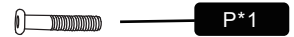
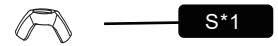

Installation Steps

Materials

STEP7

Cover the iron back frame with a cloth cover.

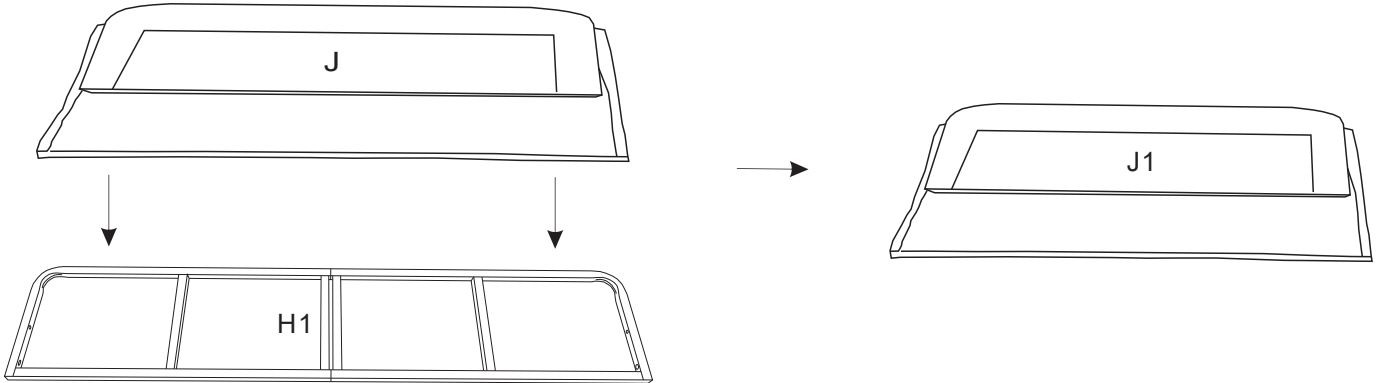
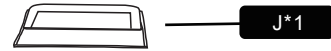

STEP8

The iron back frame is fixed to the armrest.

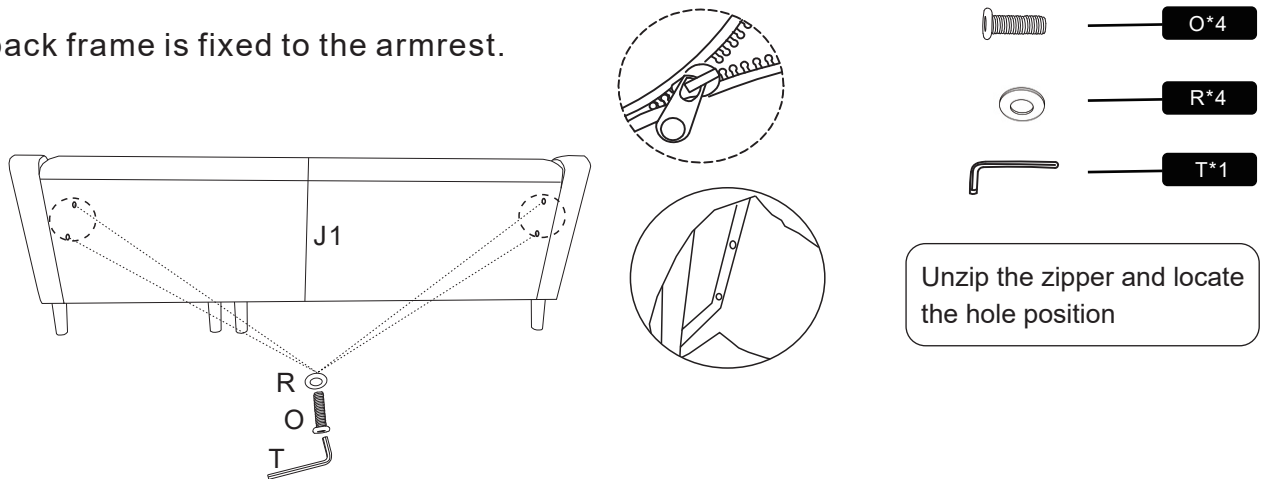

Lock the iron back frame and then lock the armrest.

STEP9

Unpack the compression pack and put it into the corresponding cloth cover to fully fill within 72 hours.

After the soft cushion is unfolded, it can be kneaded by hand to aid in recovery.

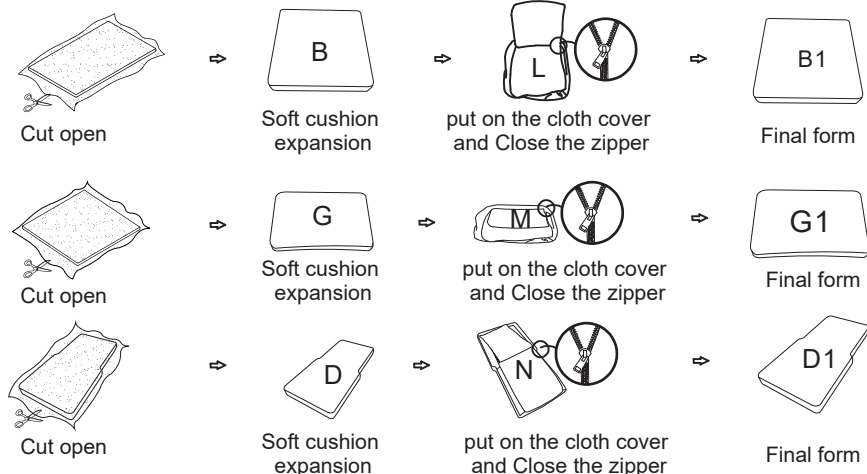

Installation Steps

Materials ▾

STEP10

Place backpacks, seat bags, and chaise longue bags in the corresponding positions.

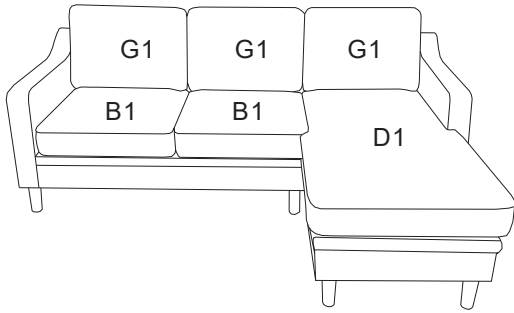

or

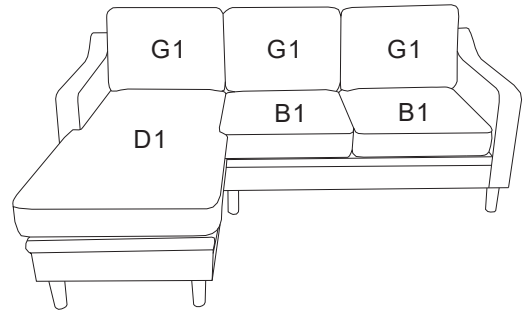

COMPLETE

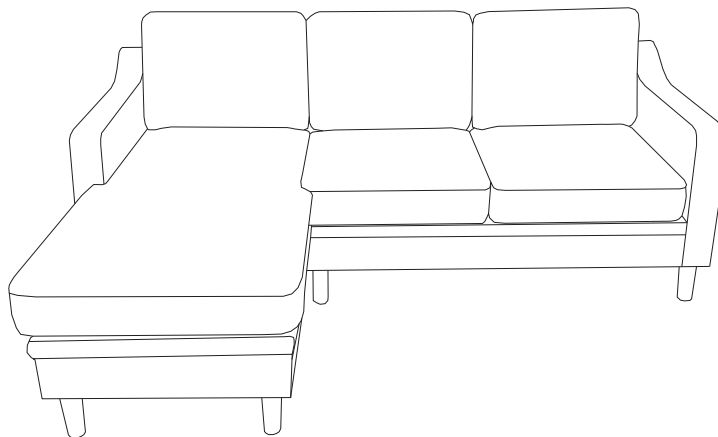
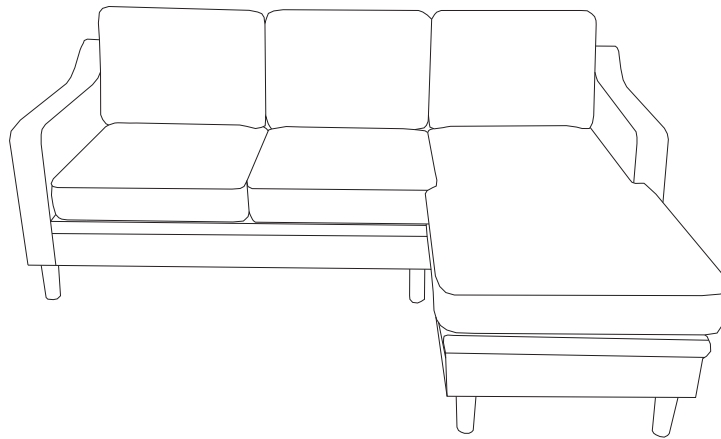

Frequently Asked Questions

We understand that receiving damaged or defective products can be disappointing, and we're here to assist you every step of the way. Here's how to address common concerns and initiate a damage claim:

1.What should I do if my shipment is damaged or products received are defective?

We're genuinely sorry to hear about any inconvenience caused. Please reach out to us promptly, and our team will prioritize resolving the matter swiftly and effectively, please retain the original box in case a return is required.

2.Can I return the product if I'm not satisfied?

While we uphold stringent quality standards and collaborate with experienced manufacturers, we acknowledge that dissatisfaction may arise. If you're still unsatisfied, of receiving the product. Simply message us with your reasons for return, and we'll facilitate the process.