

Pure & Easy



ASSEMBLY INSTRUCTIONS

FTPLSS-3030 FTPLSS-3031
FTPLSS-3035 FTPLSS-3036

NBLHBJ-V1

NOTICE

IMPORTANT, RETAIN FOR FUTURE REFERENCE: READ CAREFULLY
WICHTIG, FÜR SPÄTERE NACHSCHLAGE AUFBEWAHREN: SORGFÄLTIG LESEN
IMPORTANTE, GUARDAR PARA REFERENCIA FUTURA: LEER ATENTAMENTE
IMPORTANTE, CONSERVARE PER RIFERIMENTI FUTURI: LEGGERE ATTENTAMENTE
IMPORTANT, À CONSERVER POUR RÉFÉRENCE FUTURE : LIRE ATTENTIVEMENT

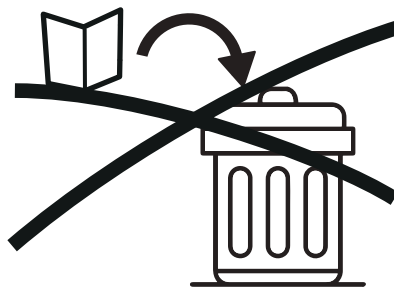
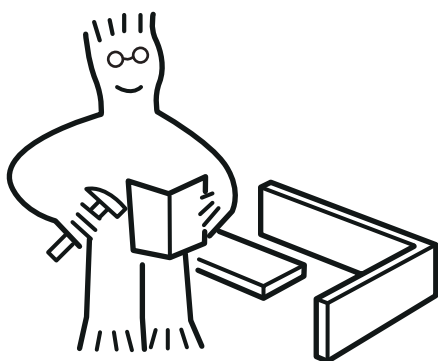

Assemble on a flat, clean and soft surface.
Auf einer flachen, sauberen und weichen Oberfläche zusammenbauen.
Assembler sur une surface plate, propre et douce.
Assemblare su una superficie piatta, pulita e morbida.
Ensamblar sobre una superficie plana, limpia y suave.

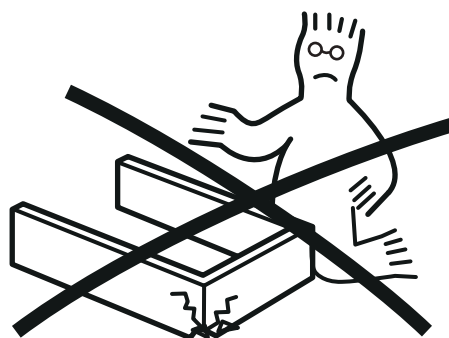
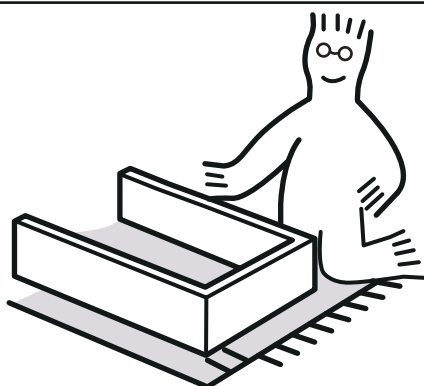

Professional installation is highly recommended.
Eine professionelle Installation wird dringend empfohlen.
Une installation professionnelle est fortement recommandée.
Si raccomanda vivamente l'installazione professionale.
Se recomienda altamente la instalación profesional.



Periodically Check That All Components Are Tightly Secured.
Überprüfen Sie Regelmäßig, Dass Alle Komponenten Fest Gesichert Sind.
Vérifiez Périodiquement Que Tous Les Composants Sont Bien Fixés.
Controllare Periodicamente Che Tutti I Componenti Siano Ben Fissati.
Verifique Periódicamente Que Todos Los Componentes Estén Bien Asegurados.

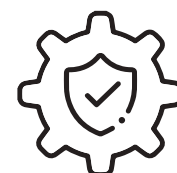

It is recommended that multiple people assemble this product.
Es wird empfohlen, dass mehrere Personen dieses Produkt zusammenbauen.
Il est recommandé que plusieurs personnes assemblent ce produit.
Si raccomanda che più persone assemblino questo prodotto.
Se recomienda que varias personas ensamblen este producto.

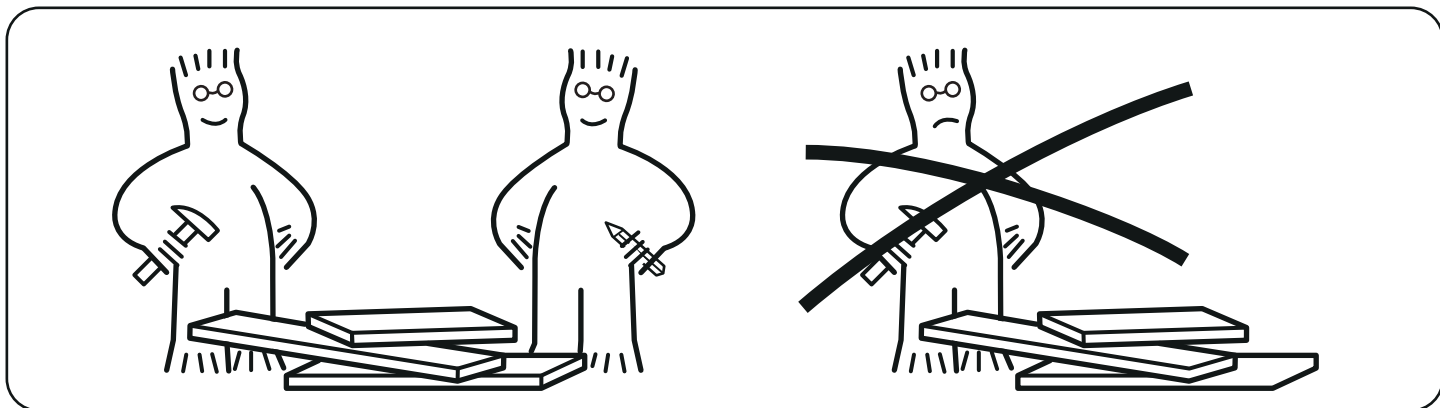

Please contact us if parts of your furniture are missing.
Bitte kontaktieren Sie uns, wenn Teile Ihrer Möbel fehlen.
Por favor contáctenos si faltan piezas de sus muebles.
Si prega di contattarci se mancano parti dei vostri mobili.
Veuillez nous contacter si des pièces de vos meubles manquent.

Before you start, separate and identify all the parts and panels to be sure that you have all the necessary parts for your building.
Bevor Sie beginnen, trennen Sie alle Teile und Paneele und identifizieren Sie diese, um sicherzustellen, dass Sie alle notwendigen Teile für den Aufbau haben.
Avant de commencer, séparez et identifiez toutes les pièces et panneaux pour vous assurer que vous avez toutes les pièces nécessaires pour votre construction.
Prima di iniziare, separare e identificare tutte le parti e i pannelli per essere sicuri di avere tutte le parti necessarie per la costruzione.
Antes de comenzar, separe e identifique todas las piezas y paneles para asegurarse de que tiene todas las piezas necesarias para su construcción.

Review all the instructions and the appropriate information before you begin, and make sure to follow the step sequence carefully for successful results.
Überprüfen Sie alle Anweisungen und die entsprechenden Informationen, bevor Sie beginnen, und stellen Sie sicher, dass Sie die Schrittfolge sorgfältig befolgen, um erfolgreiche Ergebnisse zu erzielen.
Revoyez toutes les instructions et les informations appropriées avant de commencer, et assurez-vous de suivre soigneusement la séquence des étapes pour obtenir des résultats réussis.
Rivedere tutte le istruzioni e le informazioni appropriate prima di iniziare e assicurarsi di seguire attentamente la sequenza di passaggi per ottenere risultati di successo.
Revise todas las instrucciones y la información adecuada antes de comenzar, y asegúrese de seguir cuidadosamente la secuencia de pasos para obtener resultados exitosos.

Follow the steps to open the parts' bags and do not open all the bags in one time in case of mixture of parts.

Befolgen Sie die Schritte, um die Beutel mit den Teilen zu öffnen, und öffnen Sie nicht alle Beutel auf einmal, um eine Vermischung der Teile zu vermeiden.

Suivez les étapes pour ouvrir les sacs de pièces et ne les ouvrez pas tous en même temps pour éviter tout mélange de pièces.

Seguire i passaggi per aprire i sacchetti delle parti e non aprirli tutti contemporaneamente per evitare la miscelazione delle parti.

Siga los pasos para abrir las bolsas de las piezas y no abra todas las bolsas a la vez para evitar la mezcla de piezas.

The company will not be responsible for any losses caused by parts' damage due to incorrect installation methods, and the customer shall bear the responsibility on their own.

Die Firma übernimmt keine Verantwortung für Verluste, die durch Beschädigung von Teilen aufgrund falscher Installationsmethoden verursacht werden, und der Kunde trägt die Verantwortung selbst.

La société ne sera pas responsable des pertes causées par des dommages aux pièces dus à des méthodes d'installation incorrectes, et le client devra assumer la responsabilité par lui-même.

L'azienda non sarà responsabile di eventuali perdite causate da danni alle parti dovuti a metodi di installazione errati, e il cliente dovrà assumersi la responsabilità da solo.

La empresa no será responsable de ninguna pérdida causada por daños en las piezas debido a métodos de instalación incorrectos, y el cliente deberá asumir la responsabilidad por su cuenta.



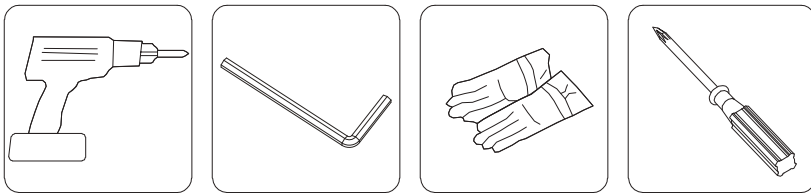



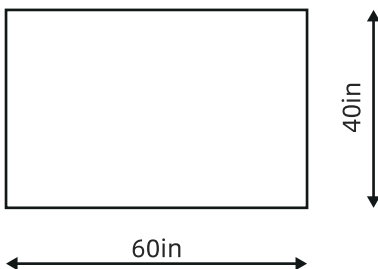

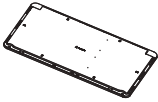
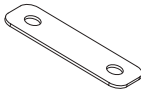
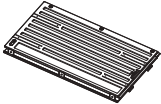

Please have the following auxiliary tools ready:

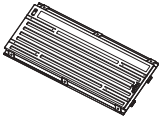

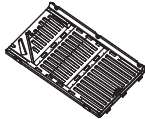
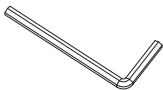
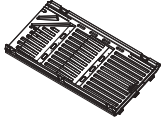
Area of installation requirement:

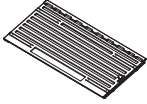
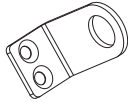
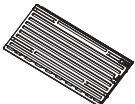
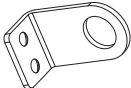

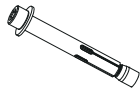
PARTS

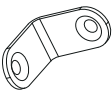
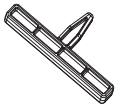
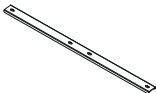
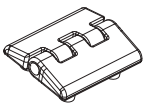
Item no.	Reference Image	Qty.	Item no.	Reference Image	Qty.
A		X1	N		X20
B		X2	O	 M5×14mm	X88
C		X2	P		X18
D		X2	Q		X1
E		X2	S	 M4×10mm	X8
F		X2	T		X1
G		X2	U		X1
H		X1	V		X4
J		X1	W		X2
K		X1	X		X12
M		X10			

EXPLODED VIEW

MIDDLE&UNDER

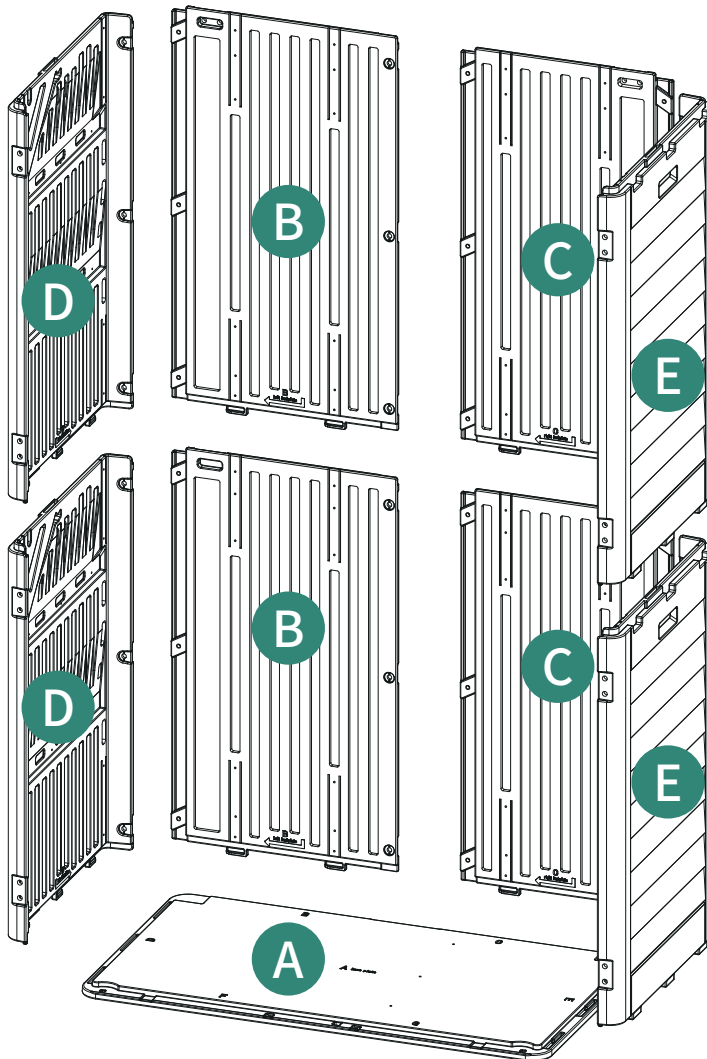
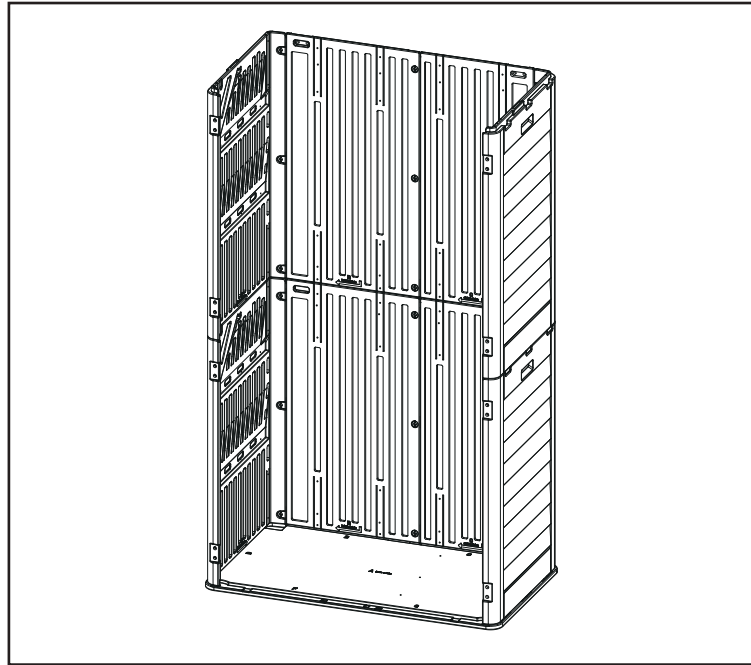

FRONT&UPPER

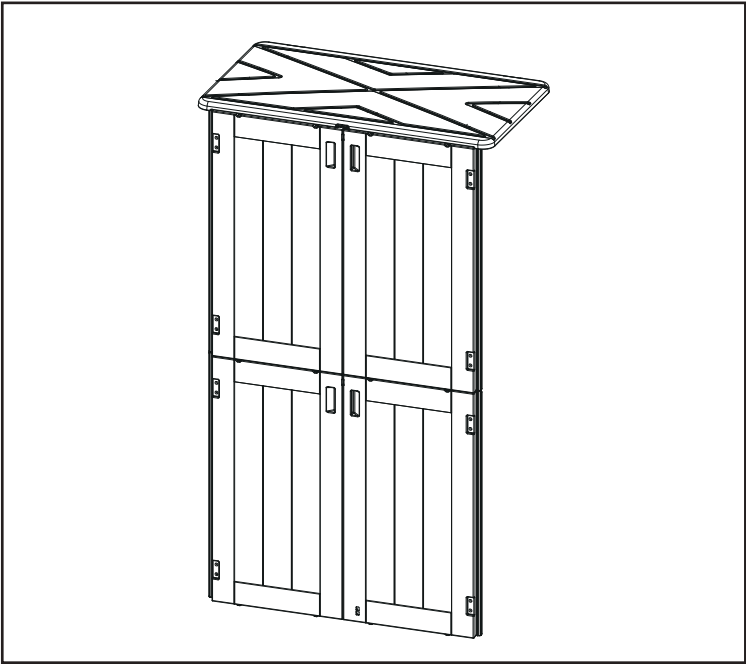

ASSEMBLY

1

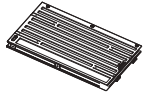

ⓑ 1pc



ⓒ 1pc



Ⓟ 3pcs



Ⓠ 1pc

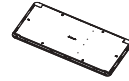

Ⓐ 1pc

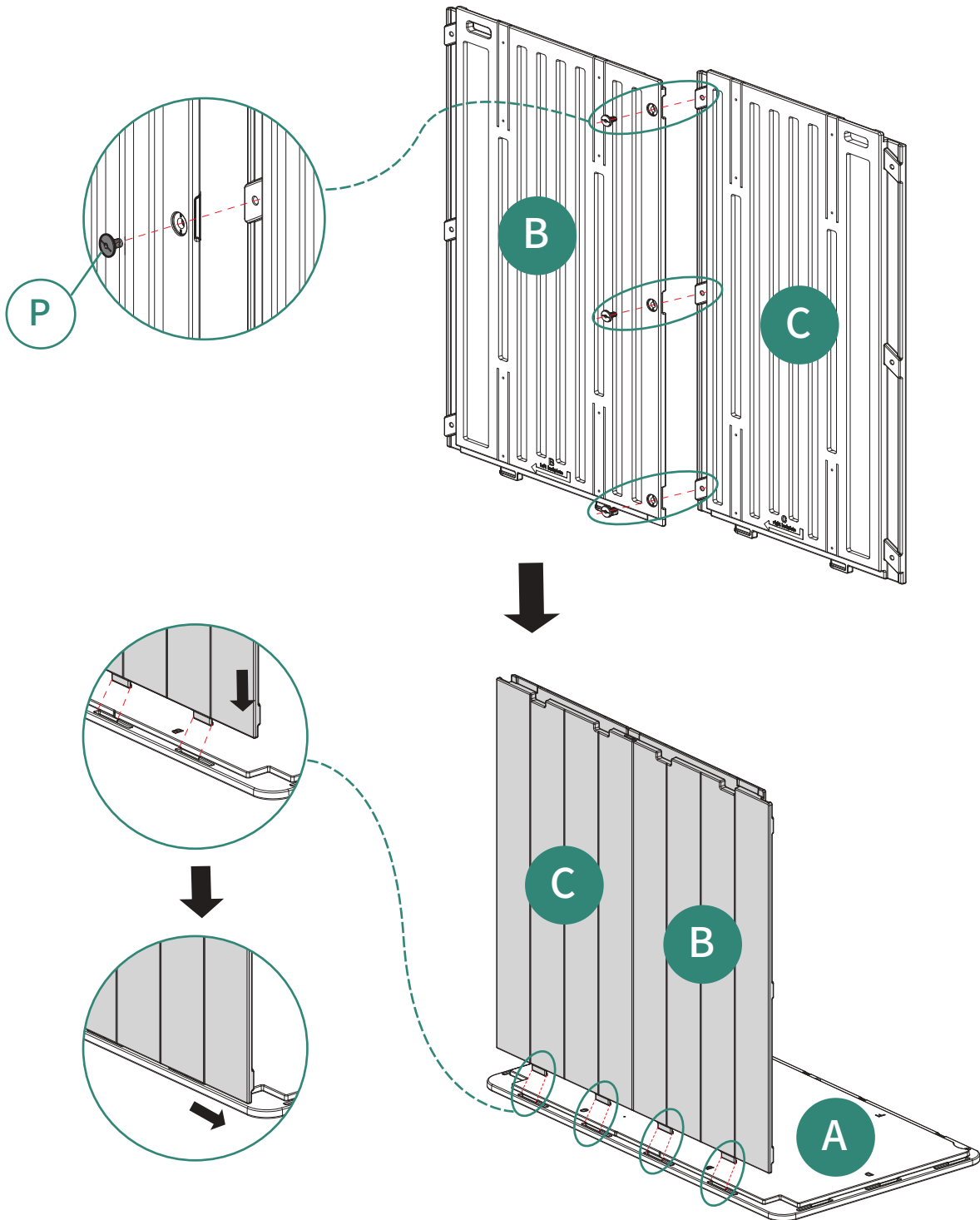

2



D 2pcs



E 2pcs



O 16pcs

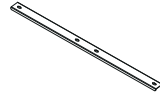

X 4pcs

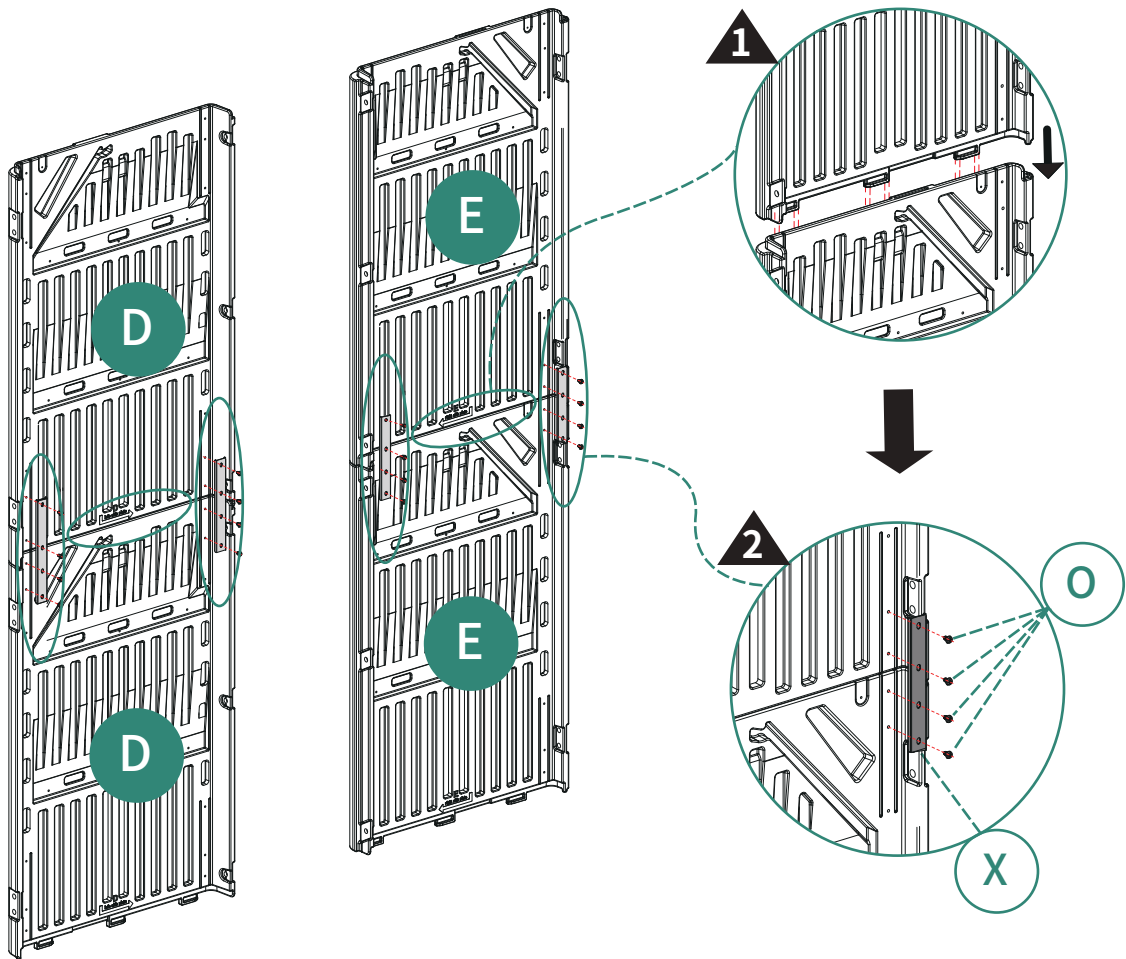

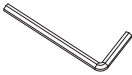
3 <hr style="border: 0; border-top: 1px solid white;"/> X2	 
	P 6pcs Q 1pc

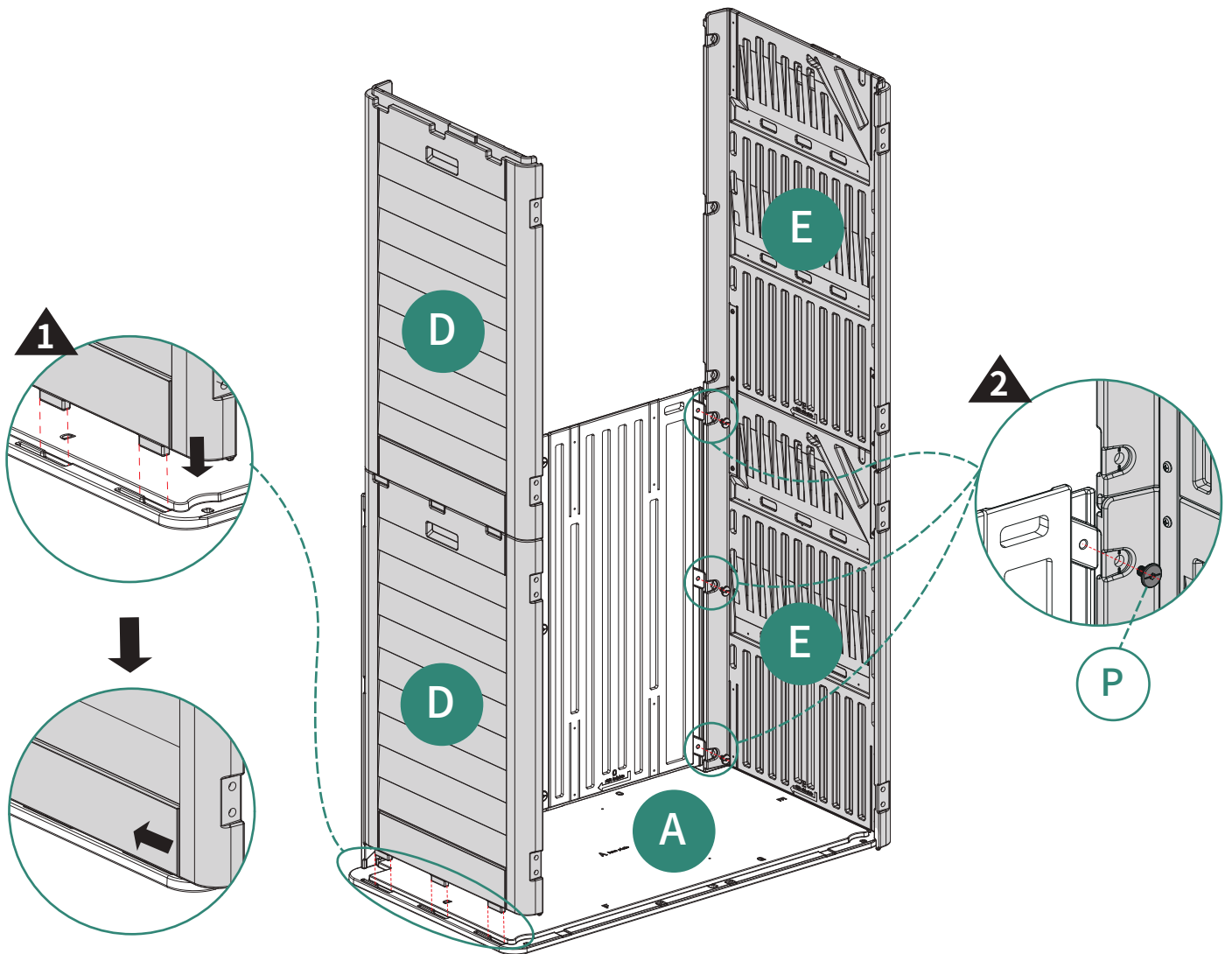

Insert the side panels into the bottom first. Secondly push the side panels in the direction of arrow. Ensure that the panels are tilted 10 degrees to the outside to pass the bump smoothly.

4

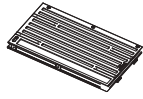

ⓑ 1pc



ⓒ 1pc



Ⓟ 3pcs



Ⓠ 1pc



Ⓞ 8pcs

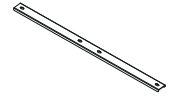

Ⓧ 4pcs

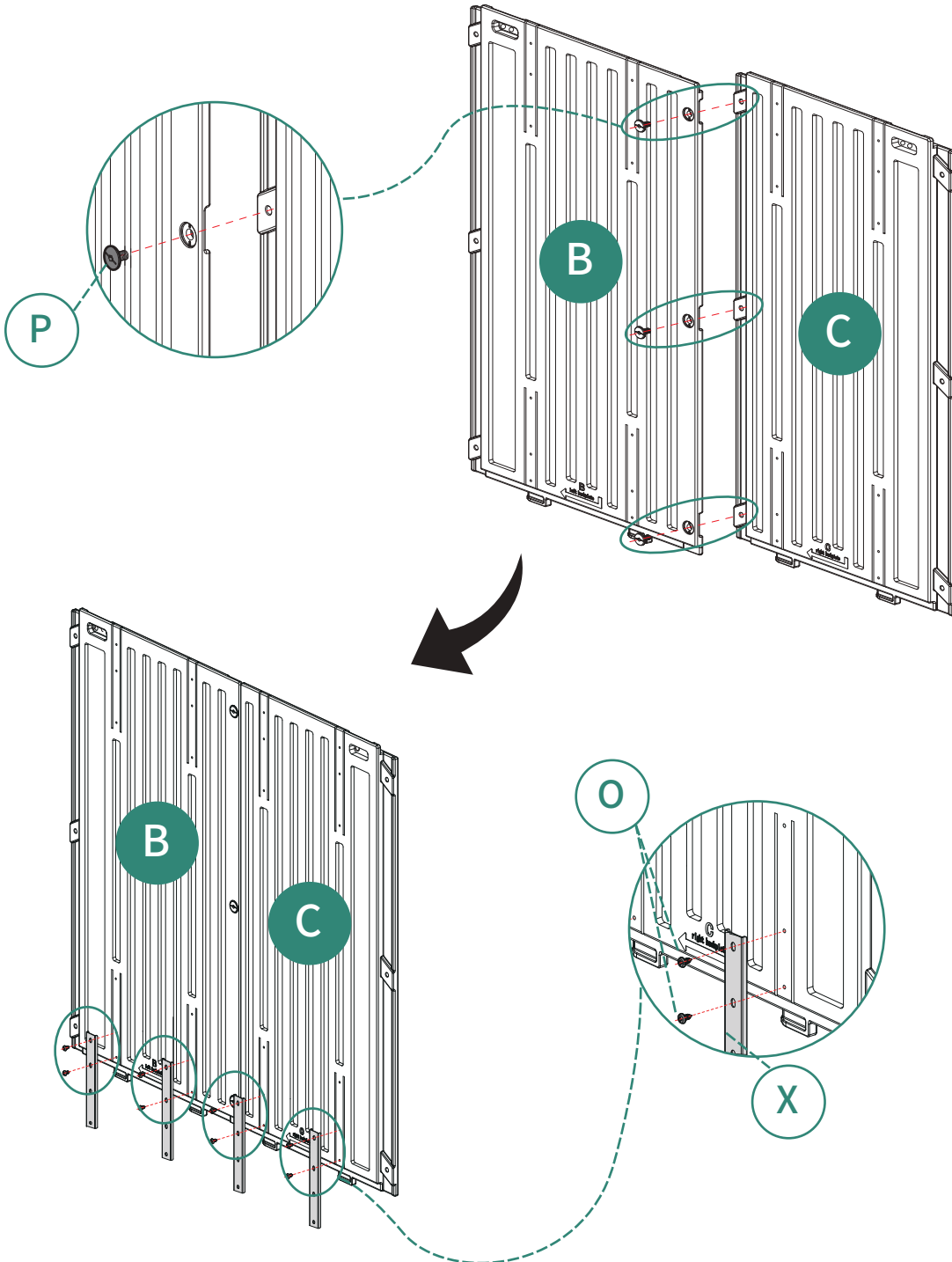

5

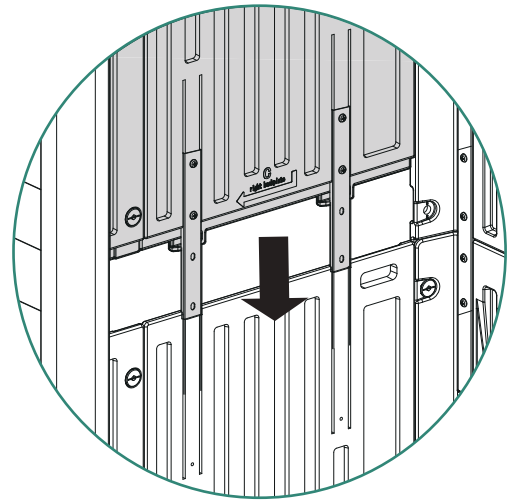
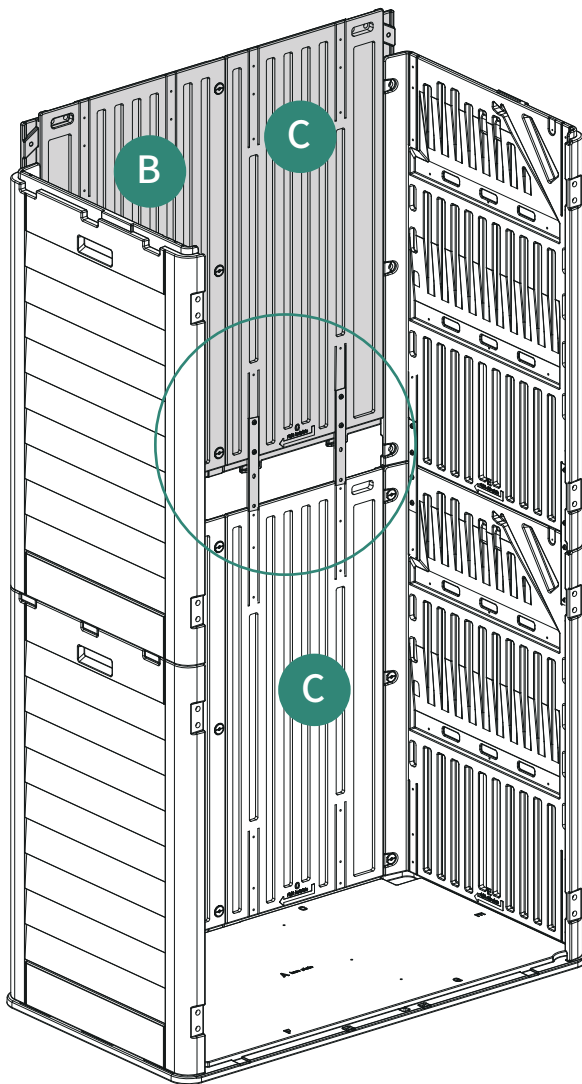

6



P 6pcs

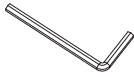

Q 1pc



O 8pcs

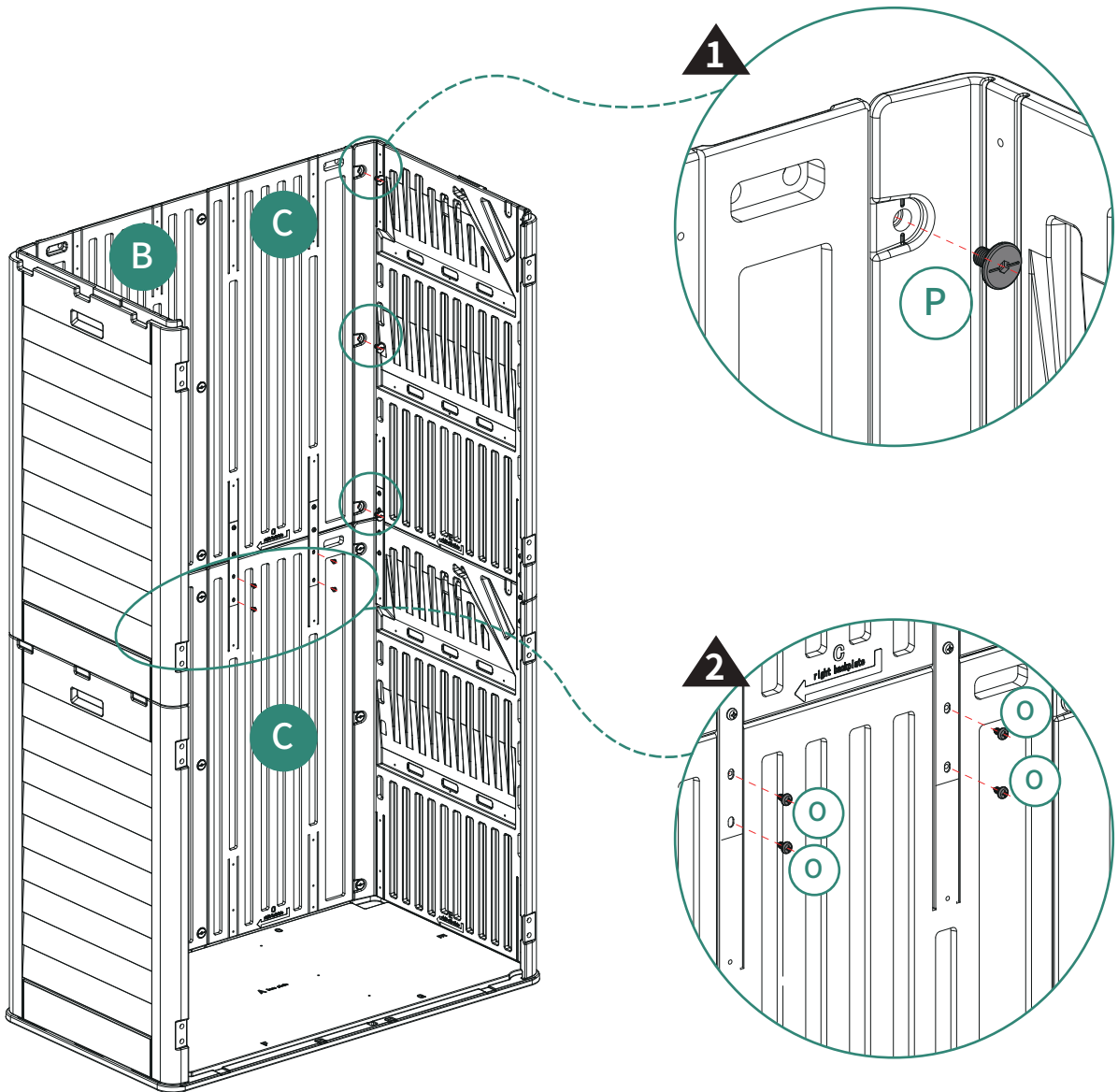

1

P

2

O

O

7



Ⓜ 1pc Ⓜ 2pcs Ⓝ 2pcs Ⓞ 4pcs

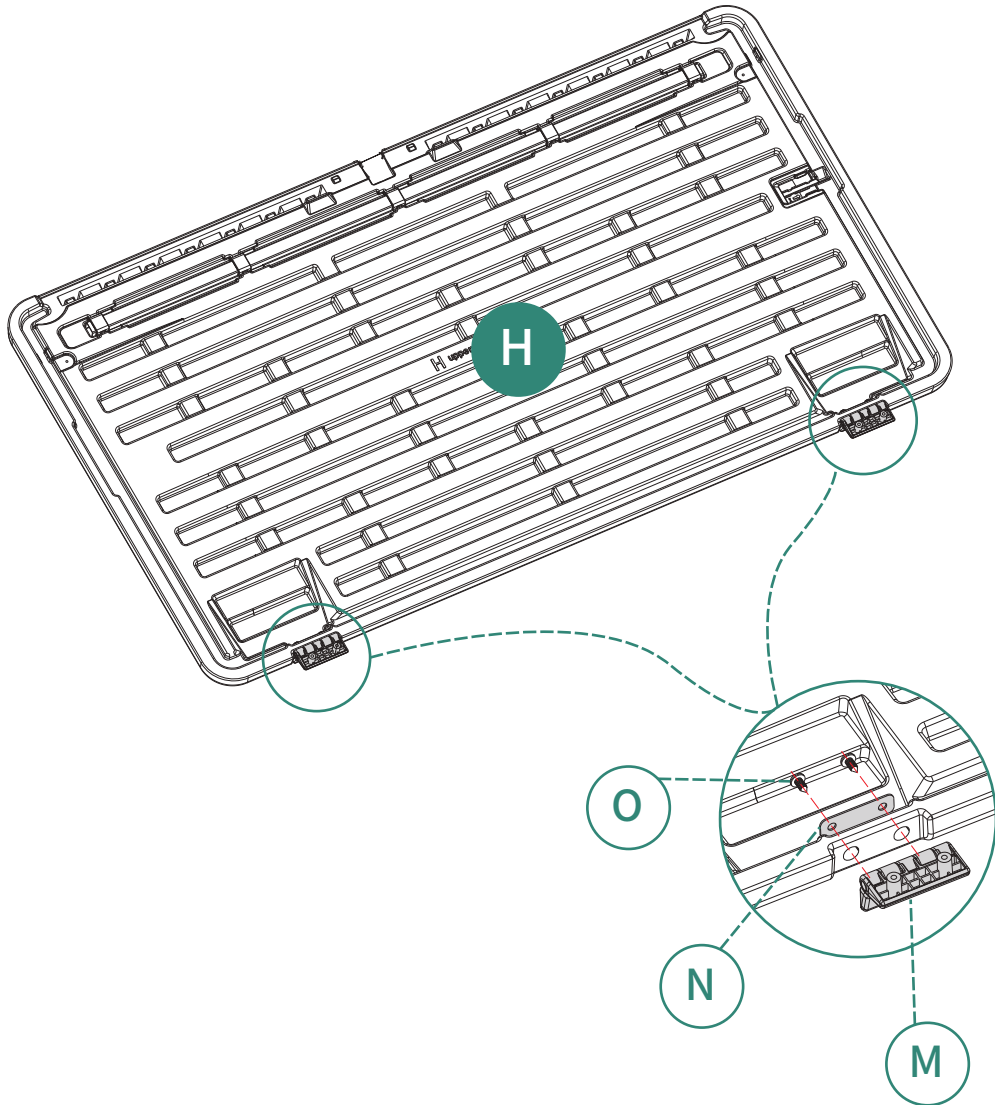

8

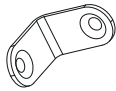
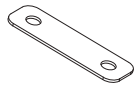

Ⓝ2pcs Ⓞ4pcs Ⓜ2pcs Ⓞ4pcs

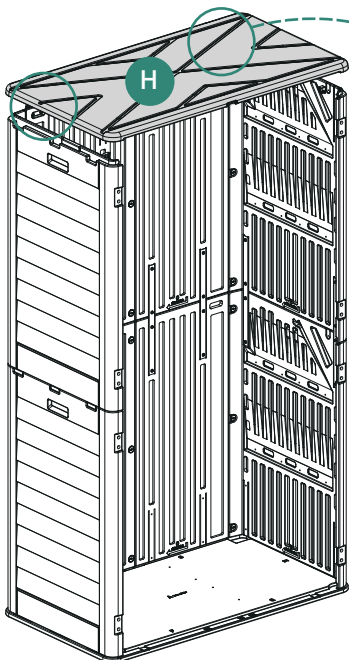
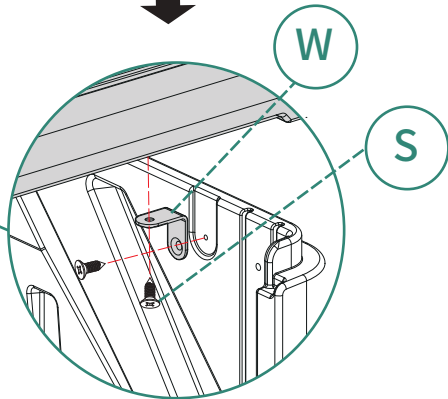
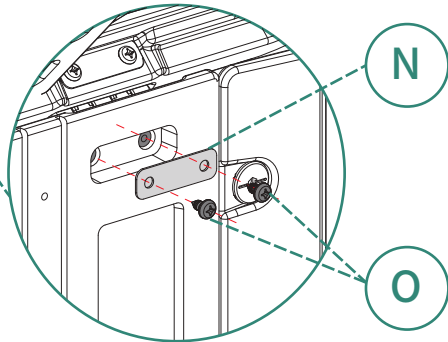
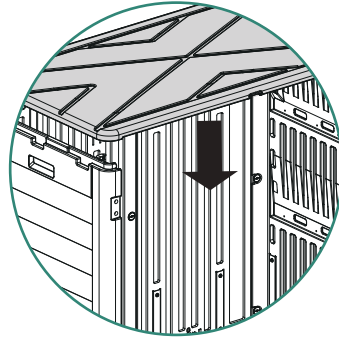
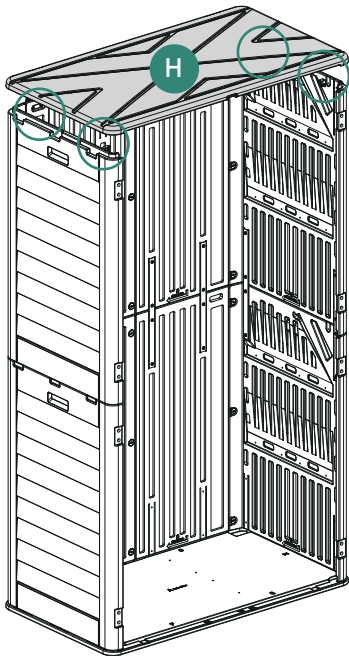

9

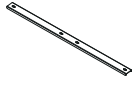
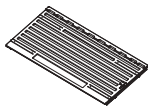

ⓕ2pcs ⓖ2pcs ⓗ4pcs ⓐ16pcs

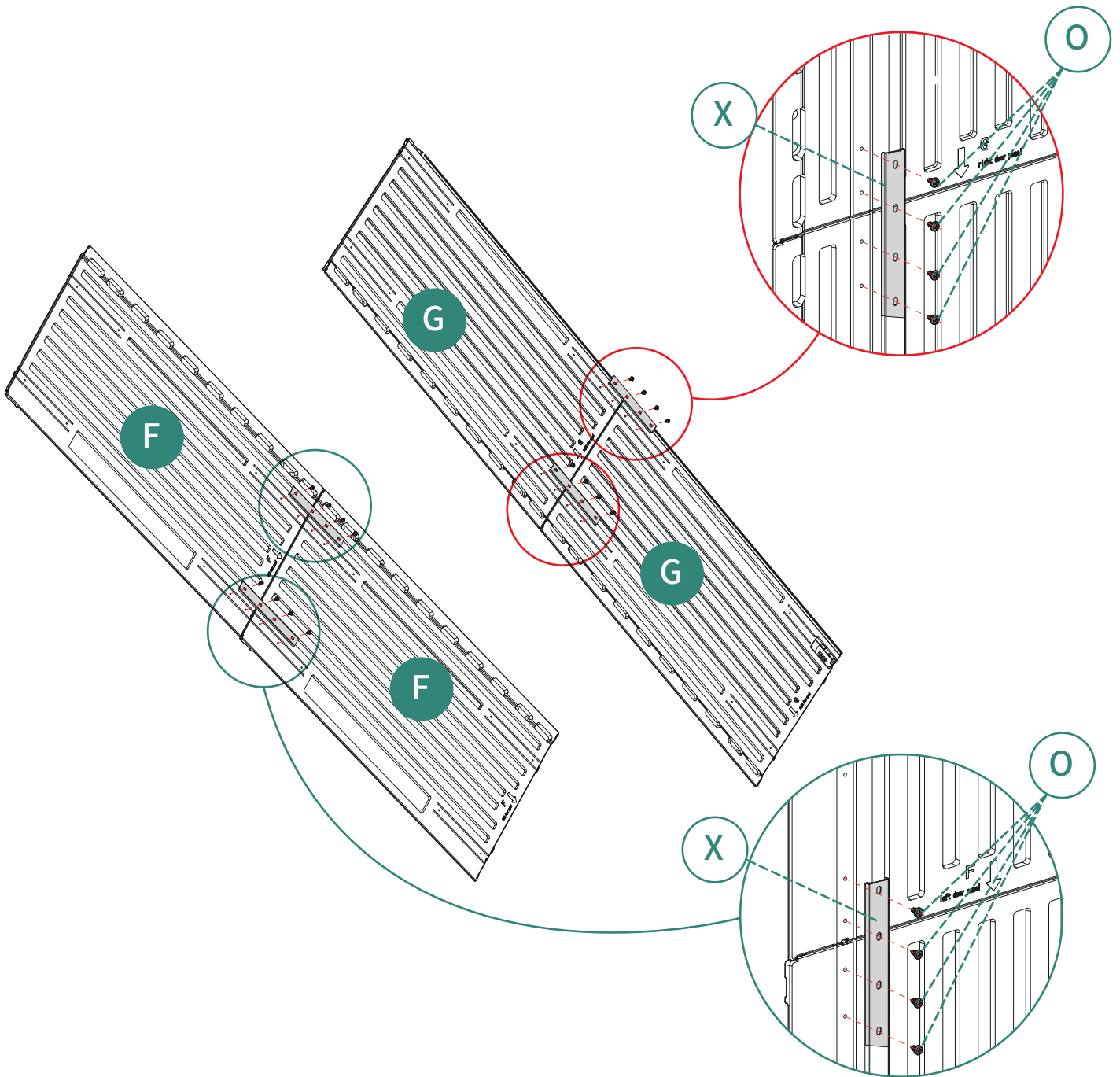

10

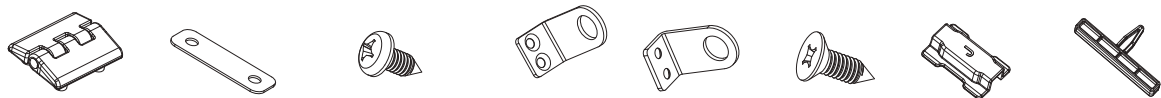

Ⓜ8pcs Ⓝ8pcs Ⓞ16pcs Ⓣ1pc Ⓤ1pc Ⓢ4pcs Ⓟ1pc Ⓚ1pc

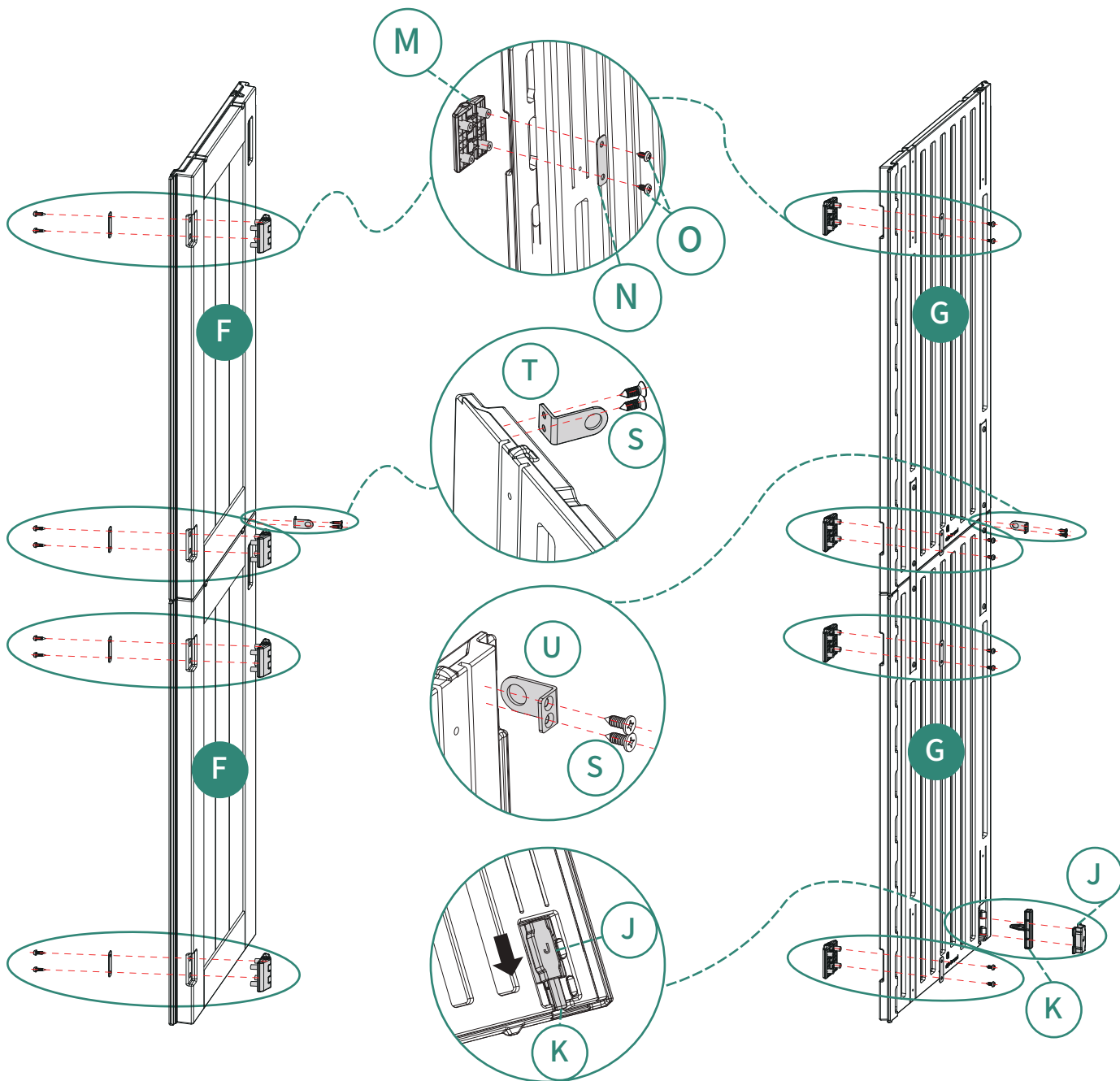

11

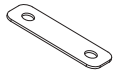

Ⓝ 8pcs

Ⓞ 16pcs

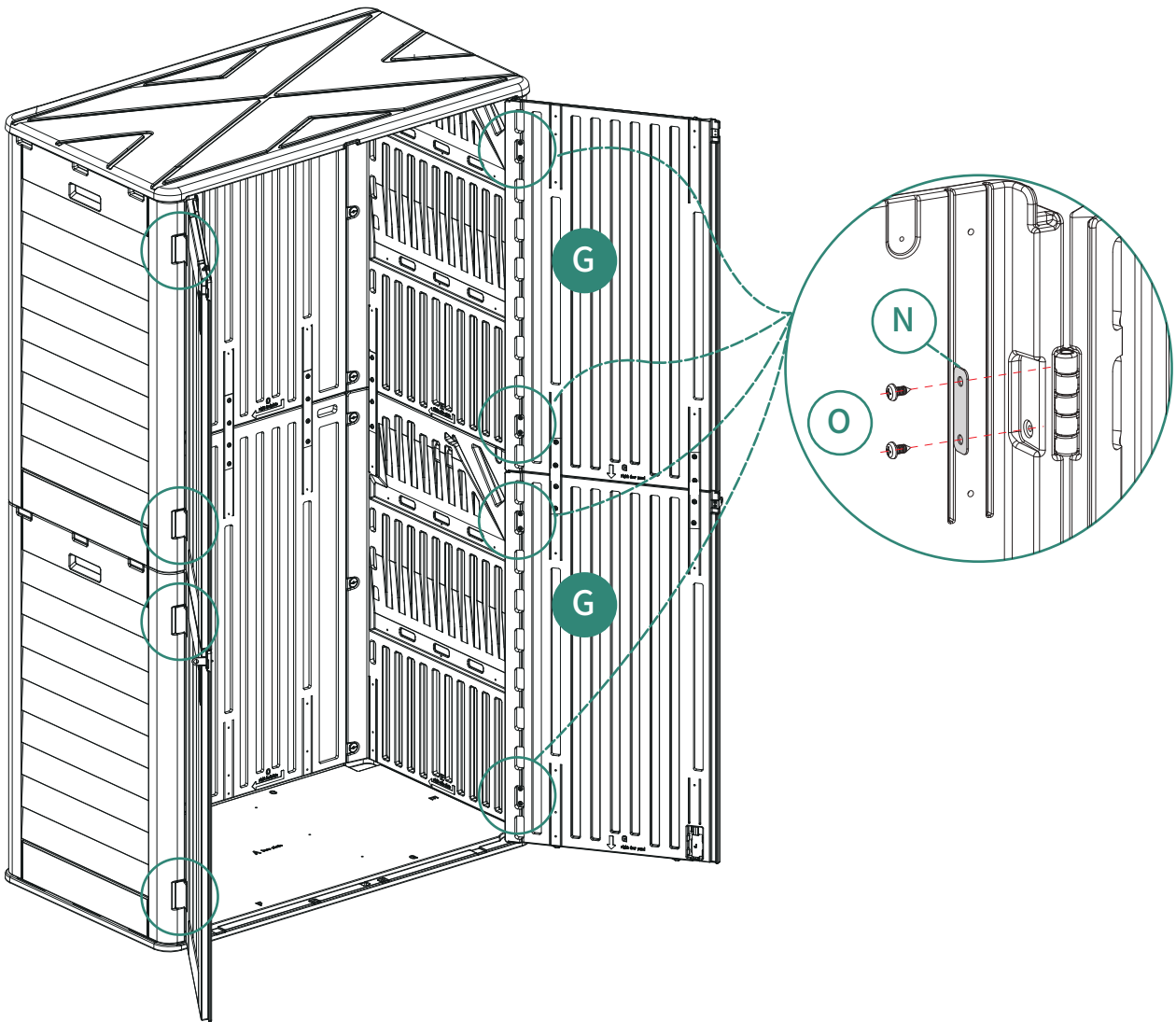

12



Ⓥ4pcs

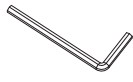

Ⓚ1pc

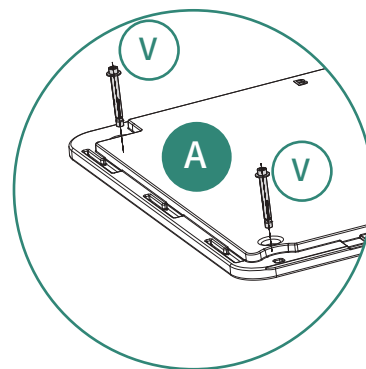
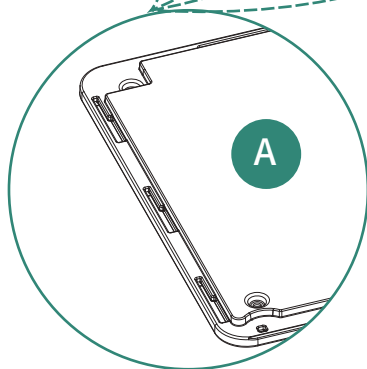
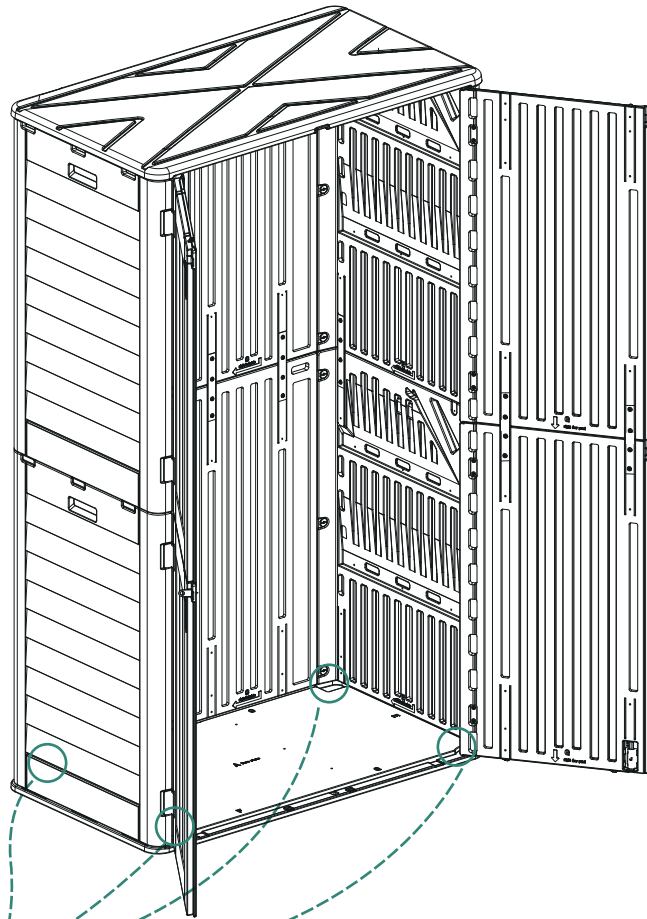

Create four screw holes by Dia.12mm drill bit, and drill four Dia.12mm mounting holes in the ground.

13



Installation Completed

Installation Abgeschlossen

Installation Complétée

Installazione Completata

Instalación Completada

You can purchase metal shelves separately if you need.

Metal Shelves Kit
For Vertical Storage Shed

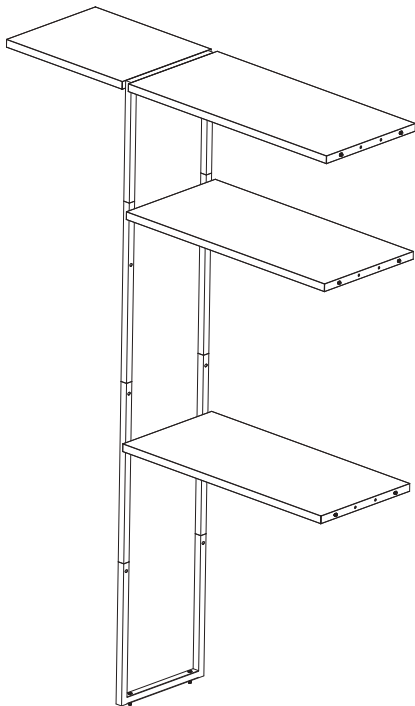

Display of finished assembly

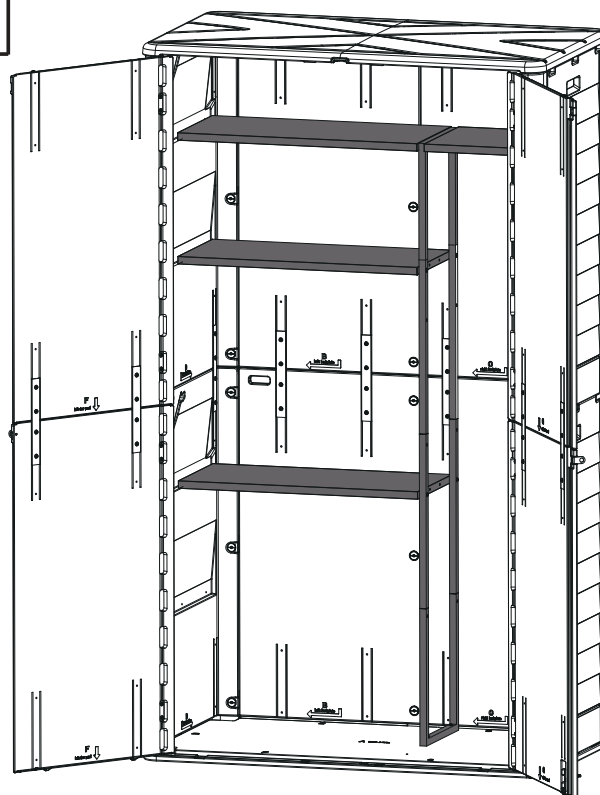

HELP CENTER



Inquiry



Assembly issue



Missing parts

If you encounter any difficulties during assembly, please contact us.

Wenn Sie während der Montage auf Schwierigkeiten stoßen, kontaktieren Sie uns bitte.

Si vous rencontrez des difficultés lors du montage, veuillez nous contacter.

Se incontri difficoltà durante il montaggio, ti preghiamo di contattarci.

Si encuentras alguna dificultad durante el ensamblaje, por favor contáctanos.

DISCLAIMER

Manufacturer and seller expressly disclaim any and all liability for personal injury, property damage or loss, whether direct, indirect, or incidental, resulting from the incorrect attachment, improper use, inadequate maintenance, unapproved modification, or neglect of this product.

Der Hersteller und Verkäufer lehnen ausdrücklich jegliche Haftung für Personenschäden, Sachschäden oder Verluste ab, egal ob direkt, indirekt oder zufällig, die durch falsche Anbringung, unsachgemäßen Gebrauch, unzureichende Wartung, nicht genehmigte Änderungen oder Vernachlässigung dieses Produkts entstehen.

El fabricante y vendedor renuncian expresamente a toda responsabilidad por lesiones personales, daños materiales o pérdidas, ya sean directos, indirectos o incidentales, derivados de la incorrecta colocación, uso inadecuado, mantenimiento insuficiente, modificación no aprobada o negligencia de este producto.

Il produttore e il venditore declinano espressamente ogni responsabilità per lesioni personali, danni materiali o perdite, dirette, indirette o incidentali, derivanti dall'errato fissaggio, uso improprio, manutenzione inadeguata, modifica non autorizzata o negligenza di questo prodotto. Le fabricant et le vendeur déclinent expressément toute responsabilité en cas de blessures corporelles, de dommages matériels ou de pertes, qu'ils soient directs, indirects ou accessoires, résultant de la fixation incorrecte, de l'utilisation inappropriée, de l'entretien insuffisant, de la modification non approuvée ou de la négligence de ce produit.