



**Upgrade · The Home Creator Way**

**DVD STORAGE**

**USER MANUAL**

**MODEL NO.: USF00302, USF00301A**

# VEVOR

Upgrade · The Home Creator Way

## DVD Storage

MODEL NO.: USF00302, USF00301A

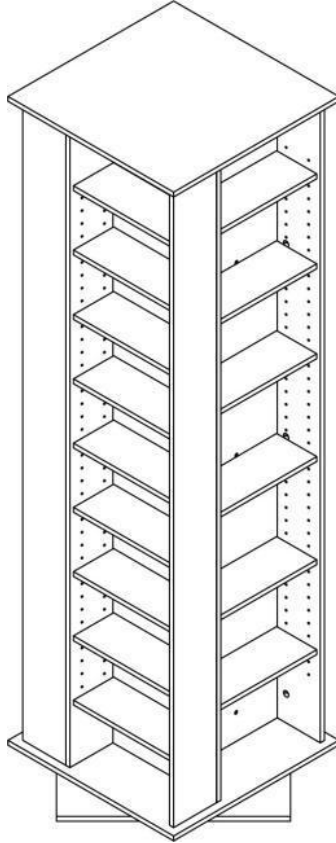

This is the original instruction, please read all manual instructions carefully before operating. VEVOR reserves a clear interpretation of our user manual. The appearance of the product shall be subject to the product you received. Please forgive us that we won't inform you again if there are any technology or software updates on our product.

 **WARNING:**

**Please read this manual carefully before using the product. Failure to do so may result in serious injury.**



Please read and observe carefully all the assembly instructions before beginning assembly.

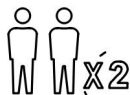

Unit should be assembled by two or more people.



**DO NOT CLIMB**

Please do not let your child climb on the product. If you have kids or animals who like to climb, we highly recommend using the wall anchors and brackets/straps that come with the package.

## **ASSEMBLY PRECAUTIONS**

1. Assemble only according to these instructions. Improper assembly can create hazards.
2. Wear ANSI-approved safety goggles and heavy-duty work gloves during assembly.
3. Keep the assembly area clean and well-lit.
4. Keep bystanders out of the area during assembly.
5. Do not assemble when tired or when under the influence of alcohol, drugs or medication.
6. The product capabilities apply to properly and completely assembled products only.

7. Assemble on a flat, level, hard and smooth surface capable of safely supporting the DVD Storage.

8. For additional information regarding the parts listed in the following pages, please refer to the Assembly Diagram of this manual. Unwrap and separate all parts in a clean work area.

SAVE THESE INSTRUCTIONS

## **USE PRECAUTIONS**

### **TO PREVENT SERIOUS INJURY AND DEATH FROM TIPPING:**

1. This product is not a toy Do not allow children to play with or near this item.

2. Do not exceed weight capacities, before moving.

3. Use only on a flat, hard and smooth surface capable of safely supporting a fully loaded DVD Storage.

4. Use as intended only.

Inspect before every use; do not use if parts are loose or damaged.

## TECHNICAL SPECIFICATIONS

Model	USF00302	USF00301A
Color	Black	Deep Coffee
Product Dimensions (LxWxH)(mm)	475*475*1636	
Net Weight(kg)	About 39.5	

\*Products such as specifications, appearance, and design are subject to modification without prior notice.

# PACKAGE CONTENTS

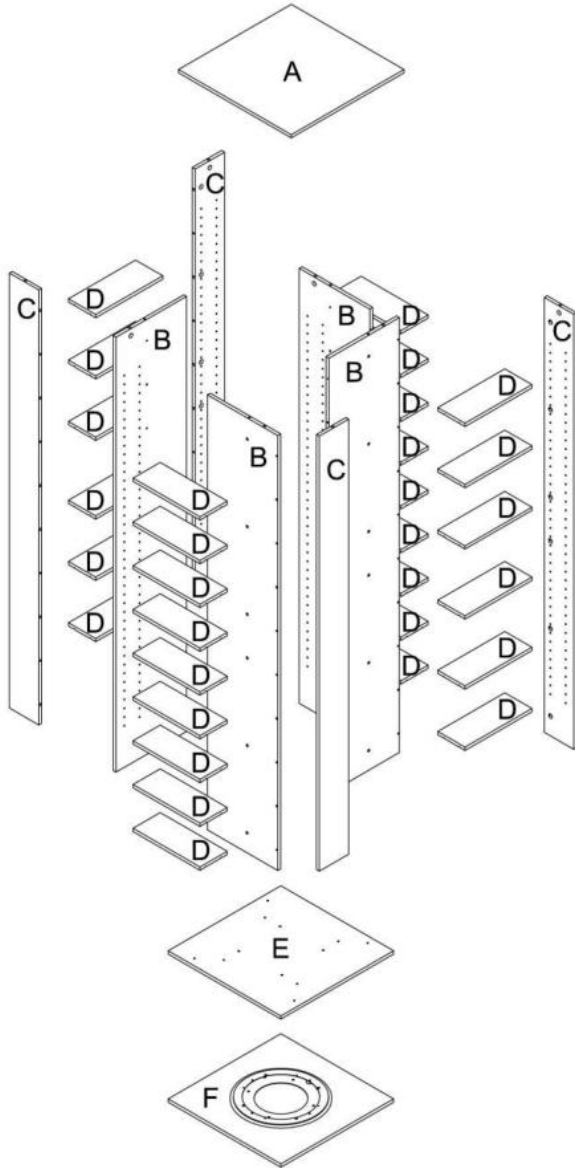

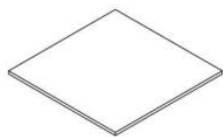

A x 1



B x 4



C x 4

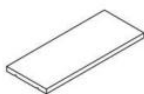

D x 30

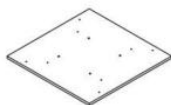

E x 1

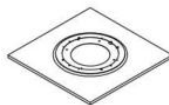

F x 1



G x 41



H x 33



I x 33



J x 121



K x 33



L x 4

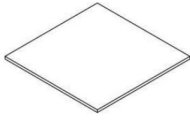

A x 1



B x 4



C x 4

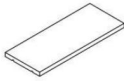

D x 30

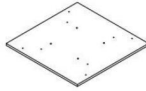

E x 1

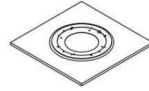

F x 1



G x 41



H x 33



I x 33



J x 121



K x 33



L x 4

Tools needed / not included

Phillips screwdriver

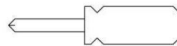

# ASSEMBLY STEPS

1



H x 24



I x 4

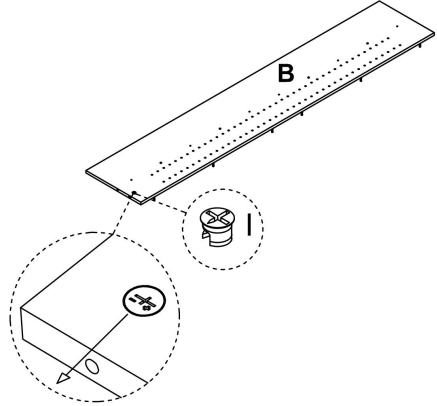
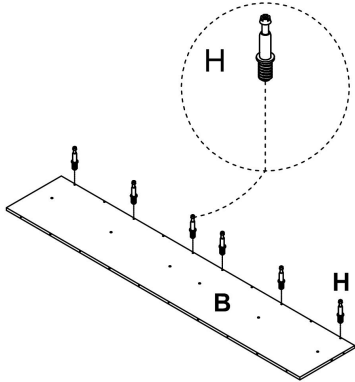

X 4

2



K x 6



G x 8

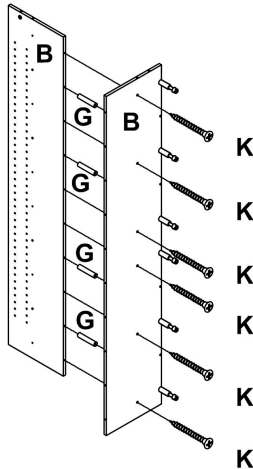

X 2

3



K x 12



G x 8

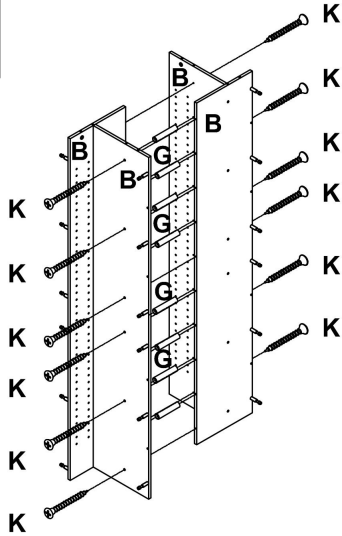

4



I x 28



G x 8

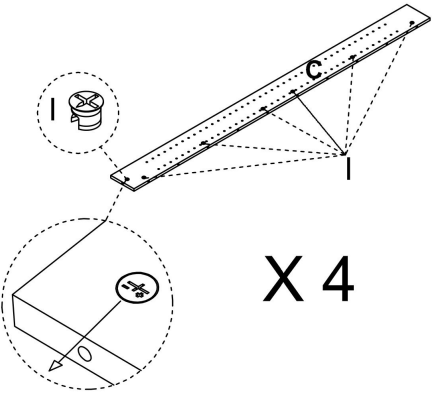
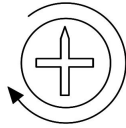

X 4

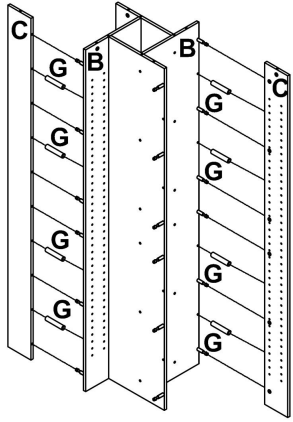

5



G x 8

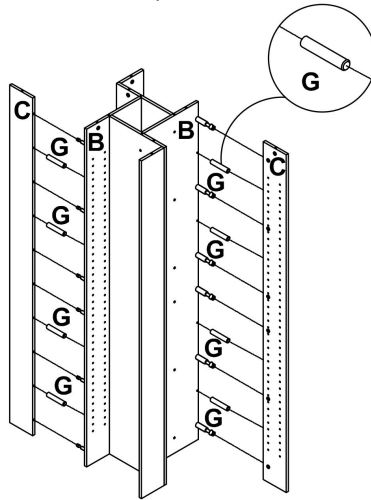
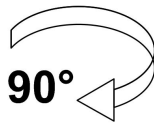
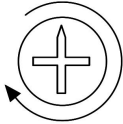

6

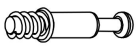

H x 8

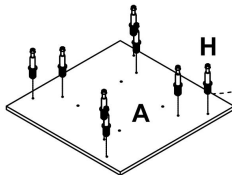
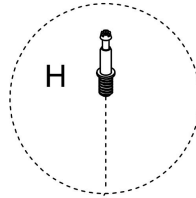

7



G x 4

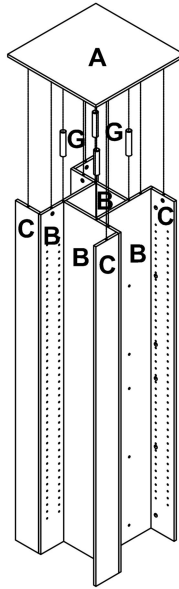

8



K x 8



G x 4

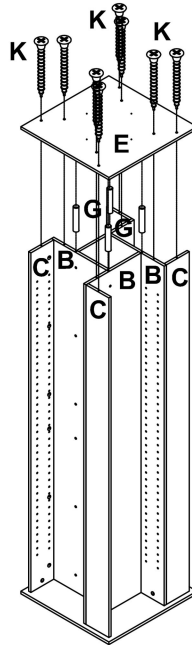

9



L x 2

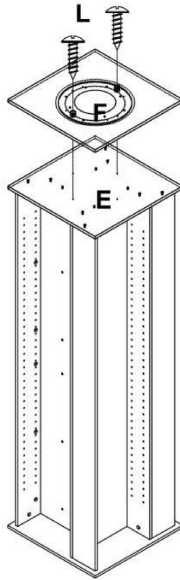

10



L x 2

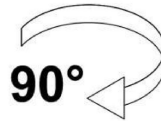
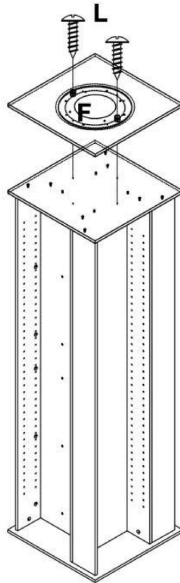

11



J x 120

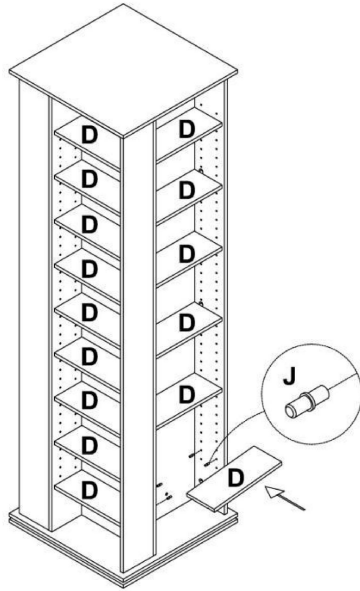

ok

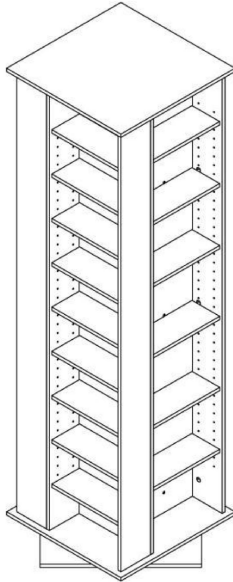

**Manufacturer:** JIN WEI WOOD CO.,LTD

**Address:** 3# XINJU ROAD ,SHANG JIAO PRECINCT,CHANG AN TOWN,DONG GUAN CITY, GUANGDONGPROVINCE,CHINA.

**Imported to AUS:** SIHAO PTY LTD. 1 ROKEVA STREETEASTWOOD NSW 2122 Australia

**Imported to USA:** Sanven Technology Ltd. Suite 250, 9166 Anaheim Place, Rancho Cucamonga, CA 91730

<b>EC</b>	<b>REP</b>
-----------	------------

E-CrossStu GmbH  
Mainzer Landstr.69, 60329 Frankfurt am Main.

<b>UK</b>	<b>REP</b>
-----------	------------

YH CONSULTING LIMITED.  
C/O YH Consulting Limited Office 147, Centurion House, London Road, Staines-upon-Thames, Surrey, TW18 4AX



# **VEVOR**

**Upgrade · The Home Creator Way**

**STOCKAGE DE DVD**

**MANUEL D' UTILISATION**

**RÉFÉRENCE : USF00302, USF00301A**

N° DE MODÈLE : USF00302, USF00301A

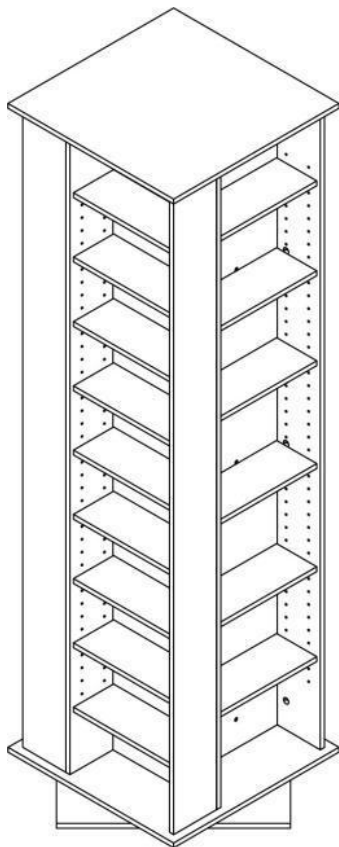

Voici le mode d'emploi original. Veuillez lire attentivement toutes les instructions du manuel avant utilisation. VEVOR se réserve le droit d'interpréter ce manuel à sa guise. L'apparence du produit que vous recevrez peut différer. Nous vous prions de nous excuser si nous ne vous informons pas des mises à jour techniques ou logicielles concernant notre produit.

 **AVERTISSEMENT:**

**Veillez lire attentivement ce manuel avant d'utiliser le produit. Le non-respect de cette consigne peut entraîner des blessures graves.**



Please read and observe carefully all the assembly instructions before beginning assembly.

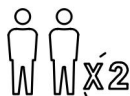

Unit should be assembled by two or more people.



DO NOT CLIMB

Please do not let your child climb on the product. If you have kids or animals who like to climb, we highly recommend using the wall anchors and brackets/straps that come with the package.

## **PRÉCAUTIONS D'ASSEMBLAGE**

9. Assembler uniquement selon ces instructions. Un assemblage incorrect peut engendrer des risques.
10. Portez des lunettes de sécurité homologuées ANSI et des gants de travail robustes pendant l'assemblage.
11. Maintenez la zone de rassemblement propre et bien éclairée.
12. Tenir les curieux à l'écart de la zone pendant le rassemblement.
13. Ne pas assembler en cas de fatigue ou sous l'influence de l'alcool, de drogues ou de médicaments.
14. Les capacités du produit s'appliquent uniquement aux produits

correctement et entièrement assemblés.

15. Assembler sur une surface plane, de niveau, dure et lisse capable de supporter le support de rangement DVD en toute sécurité.

16. Pour plus d'informations concernant les pièces mentionnées dans les pages suivantes, veuillez vous référer au schéma de montage de ce manuel. Déballez et séparez toutes les pièces dans un espace de travail propre.

CONSERVEZ CES INSTRUCTIONS

## **PRENDRE DES PRÉCAUTIONS**

**POUR ÉVITER LES BLESSURES GRAVES ET LES MORTELLES DUE AU BASCULEMENT :**

5. Ce produit n'est pas un jouet. Ne laissez pas les enfants jouer avec ou à proximité de cet article.

6. Ne dépassez pas les capacités de charge avant de procéder au déplacement.

7. À utiliser uniquement sur une surface plane, dure et lisse capable de supporter en toute sécurité un support de stockage DVD entièrement chargé.

8. Utiliser uniquement conformément à l'usage prévu.  
Inspecter avant chaque utilisation ; ne pas utiliser si des pièces sont desserrées ou endommagées.

## TECHNICAL SPECIFICATIONS

Modèle	USF00302	USF00301A
Couleur	Noir	Café corsé
Dimensions du produit (L x l x H) (mm)	475*475*1636	
Poids net (kg)	Environ 39,5	

\*Les spécifications, l'apparence et le design des produits peuvent être modifiés sans préavis.

## **PACKAGE CONTENTS**

---

---

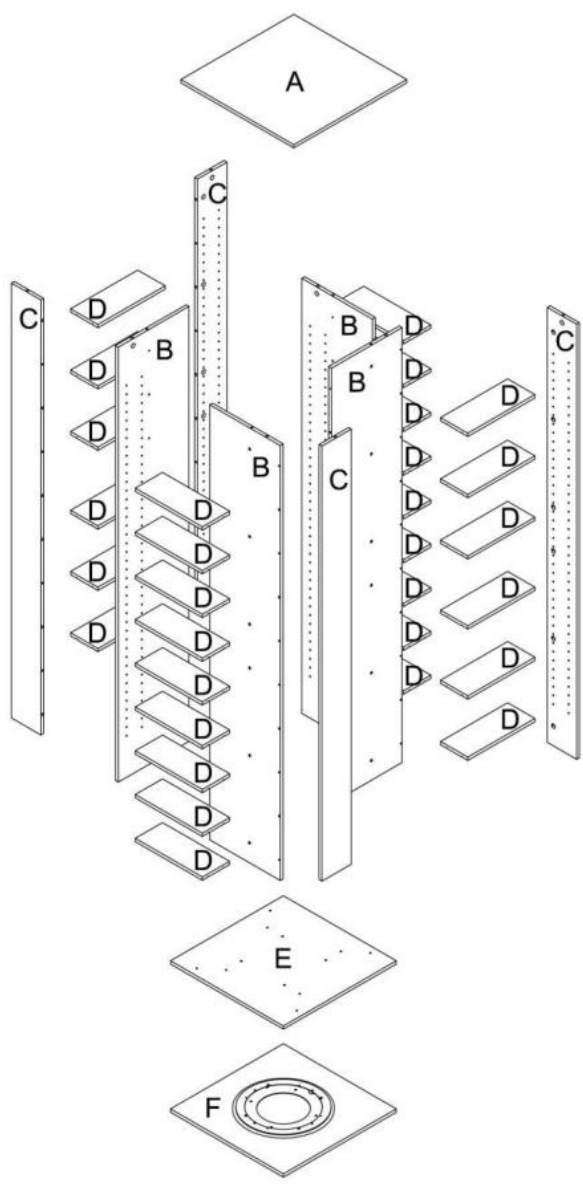

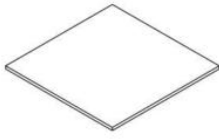

A x 1



B x 4



C x 4

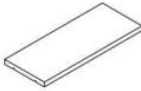

D x 30



E x 1

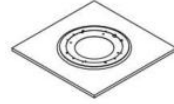

F x 1



G x 41



H x 33



I x 33



J x 121



K x 33



L x 4

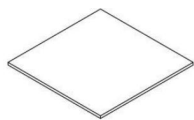

A x 1



B x 4



C x 4

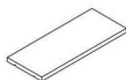

D x 30

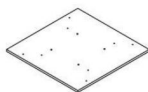

E x 1

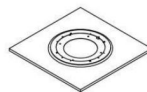

F x 1



G x 41



H x 33



I x 33



J x 121



K x 33



L x 4

### Tools needed / not included

Phillips screwdriver



# ASSEMBLY STEPS

**1**



**H x 24**



**I x 4**

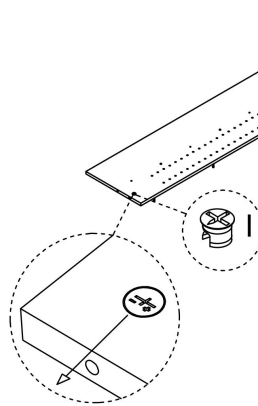
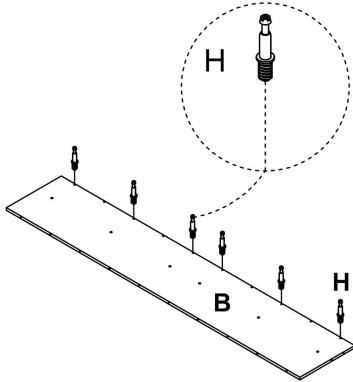

**X 4**

**2**



**K x 6**



**G x 8**

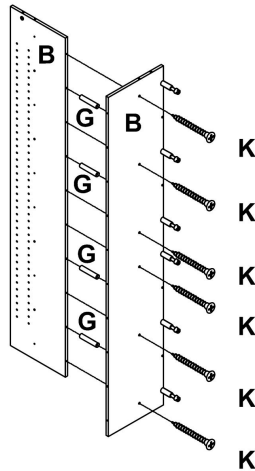

**X 2**

3



K x 12



G x 8

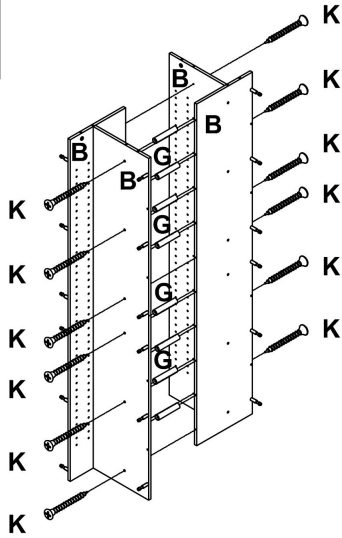

4



I x 28



G x 8

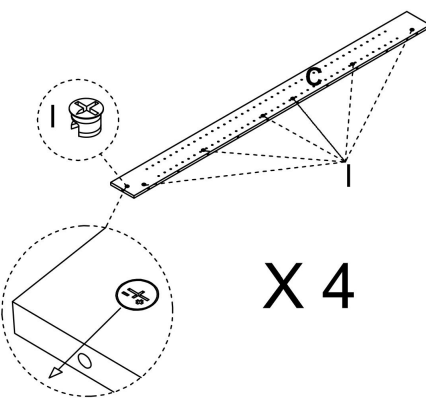
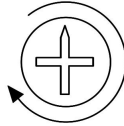

X 4

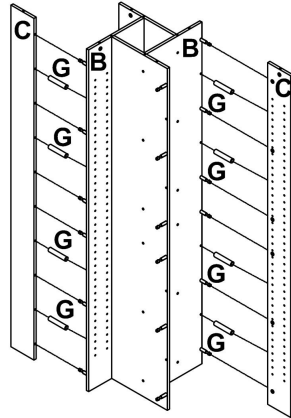

5



G x 8

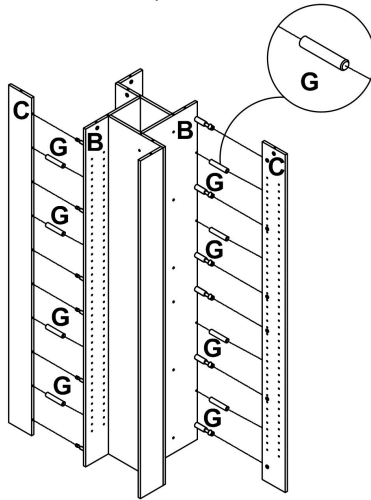
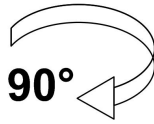
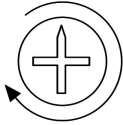

6

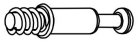

H x 8

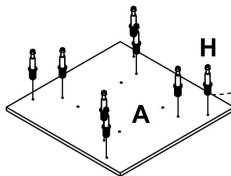
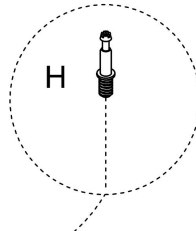

7



G x 4

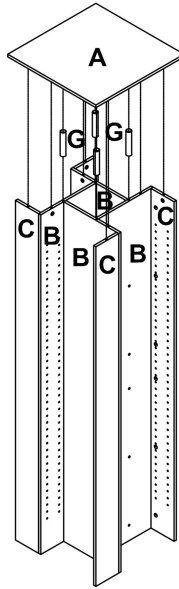

8



K x 8



G x 4

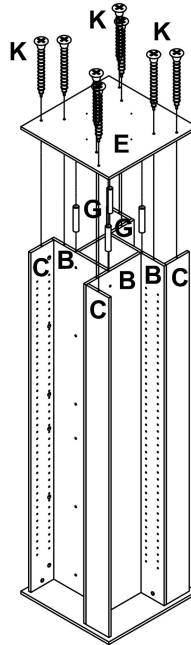

9



L x 2

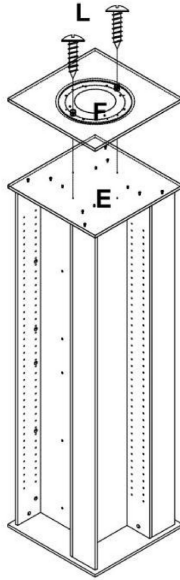

10



L x 2

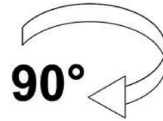
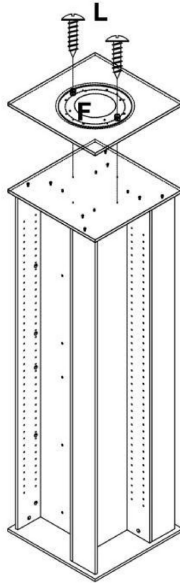

11



J x 120

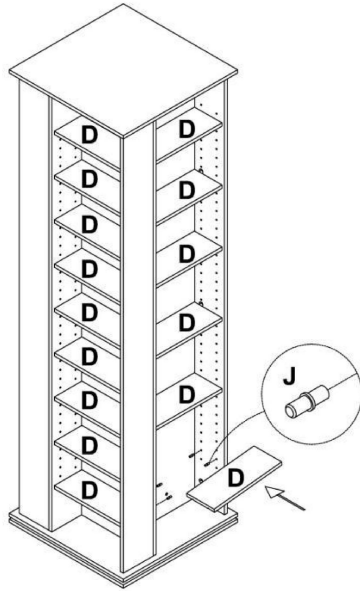

ok

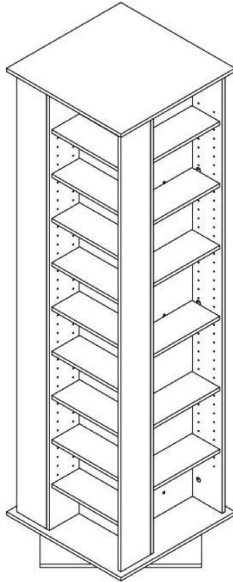

**Fabricant** : JIN WEI WOOD CO.,LTD

**Adresse** : 3 # ROUTE DE XINJU, CITÉ DE SHANG JIAO, VILLE DE CHANG, VILLE DE DONG GUAN, PROVINCE DE GUANGDONG, CHINE.

**Importé en Australie** : SIHAO PTY LTD. 1 ROKEVA STREETEASTWOOD  
NSW 2122 Australie

**Importé aux États-Unis** : Sanven Technology Ltd., Suite 250, 9166 Anaheim  
Rancho Cucamonga, CA 91730

<b>EC</b>	<b>REP</b>
-----------	------------

E-CrossStu GmbH  
Mainzer Landstr.69, 60329 Frankfurt am Main.

<b>UK</b>	<b>REP</b>
-----------	------------

YH CONSULTING LIMITED.  
C/O YH Consulting Limited Office 147, Centurion House, London Road, Staines-upon-Thames, Surrey, TW18 4AX



# **VEVOR**

**Upgrade · The Home Creator Way**

**DVD-SPEICHER**

**BENUTZERHANDBUCH**

**MODELLNR.: USF00302, USF00301A**

MODELLNR.: USF00302, USF00301A

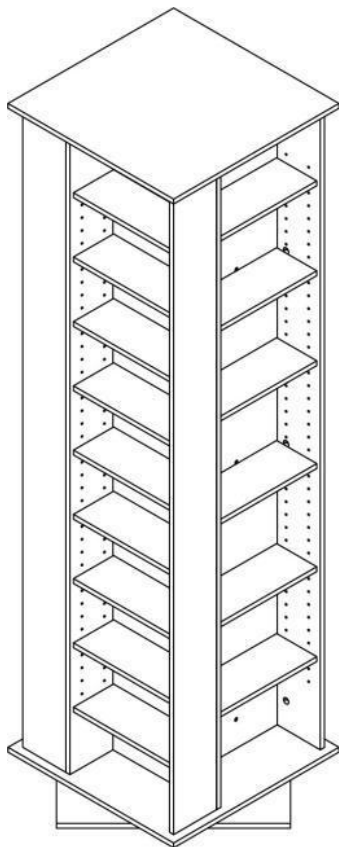

Dies ist die Originalanleitung. Bitte lesen Sie die gesamte Bedienungsanleitung vor der Inbetriebnahme sorgfältig durch. VEVOR behält sich die Auslegung der Bedienungsanleitung vor. Das Aussehen des Produkts kann von dem gelieferten Produkt abweichen. Wir bitten um Verständnis, dass wir Sie nicht erneut über etwaige Technologie- oder Software-Updates informieren werden .

 **WARNING:**

**Bitte lesen Sie diese Bedienungsanleitung vor der Verwendung des Produkts sorgfältig durch. Andernfalls kann es zu schweren Verletzungen kommen.**



Please read and observe carefully all the assembly instructions before beginning assembly.



Unit should be assembled by two or more people.



DO NOT CLIMB

Please do not let your child climb on the product. If you have kids or animals who like to climb, we highly recommend using the wall anchors and brackets/straps that come with the package.

## **VORSICHTSMASSNAHMEN BEI DER MONTAGE**

17. Bitte montieren Sie das Produkt ausschließlich gemäß dieser Anleitung. Eine unsachgemäße Montage kann Gefahren bergen.
18. Tragen Sie während der Montage eine ANSI-geprüfte Schutzbrille und robuste Arbeitshandschuhe.
19. Halten Sie den Montagebereich sauber und gut beleuchtet.
20. Halten Sie Umstehende während der Versammlung vom Versammlungsort fern.

21. Die Montage sollte nicht erfolgen, wenn man müde ist oder unter dem Einfluss von Alkohol, Drogen oder Medikamenten steht.

22. Die Produkteigenschaften gelten nur für ordnungsgemäß und vollständig montierte Produkte.

23. Montieren Sie das DVD-Laufwerk auf einer ebenen, harten und glatten Oberfläche, die das DVD-Laufwerk sicher tragen kann.

24. Weitere Informationen zu den auf den folgenden Seiten aufgeführten Teilen finden Sie in der Montagezeichnung dieses Handbuchs. Packen Sie alle Teile in einem sauberen Arbeitsbereich aus und trennen Sie sie.

BEWAHREN SIE DIESE ANWEISUNGEN AUF

## **VORSICHTSMASSNAHMEN BEACHTEN**

### **UM SCHWERE VERLETZUNGEN UND TODE DURCH UMKIPPEN ZU VERHINDERN:**

9. Dieses Produkt ist kein Spielzeug. Kinder dürfen nicht mit diesem Artikel spielen oder sich in dessen Nähe aufhalten.

10. Vor dem Transport die zulässigen Gewichtsgrenzen nicht überschreiten.

11. Nur auf einer ebenen, harten und glatten Oberfläche verwenden, die ein vollständig beladenes DVD-Laufwerk sicher tragen kann.

12. Nur bestimmungsgemäß verwenden.

Vor jedem Gebrauch prüfen; nicht verwenden, wenn Teile lose oder beschädigt sind.

## TECHNICAL SPECIFICATIONS

Modell	USF00302	USF00301A
Farbe	Schwarz	Tiefer Kaffee
Produktabmessungen (L x B x H) (mm)	475*475*1636	
Nettogewicht (kg)	Ungefähr 39,5	

\*Produktmerkmale wie Spezifikationen, Aussehen und Design können ohne vorherige Ankündigung geändert werden.

## **PACKAGE CONTENTS**

---

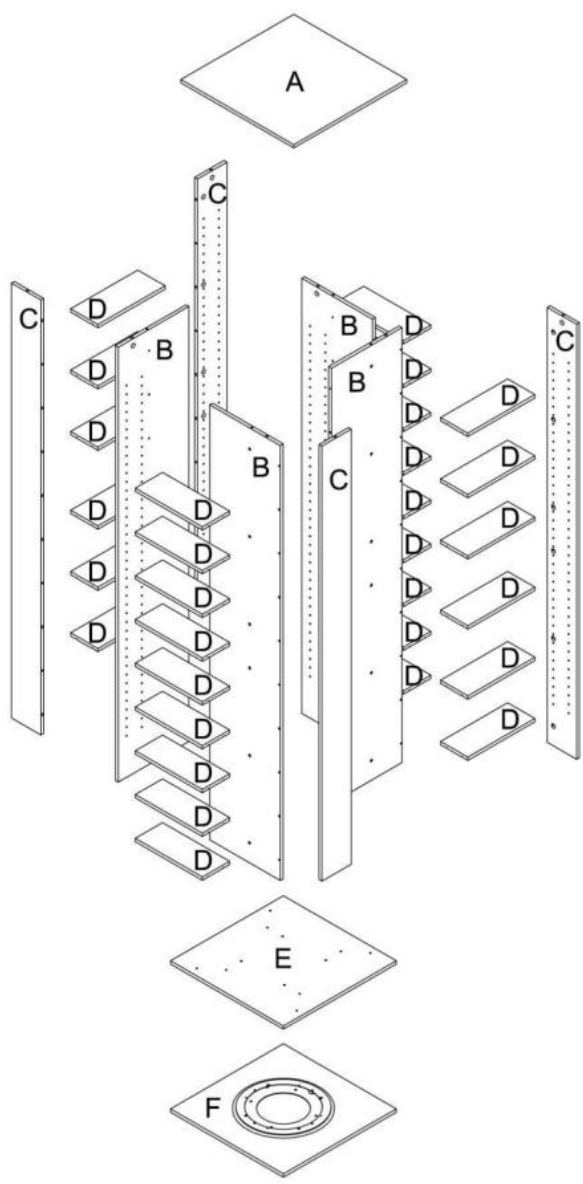

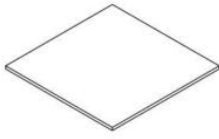

A x 1



B x 4



C x 4

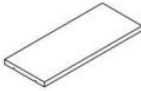

D x 30



E x 1

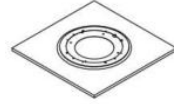

F x 1



G x 41



H x 33



I x 33



J x 121



K x 33



L x 4

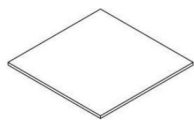

A x 1



B x 4



C x 4

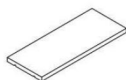

D x 30

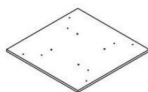

E x 1

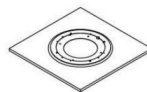

F x 1



G x 41



H x 33



I x 33



J x 121



K x 33



L x 4

### Tools needed / not included

Phillips screwdriver



# ASSEMBLY STEPS

1



H x 24



I x 4

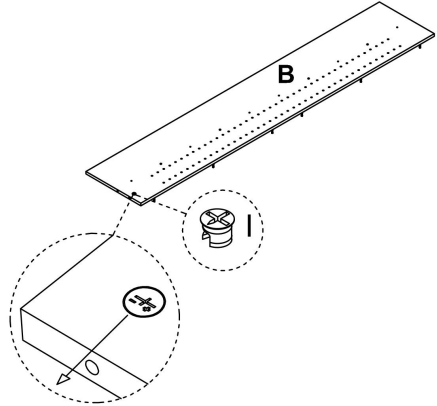
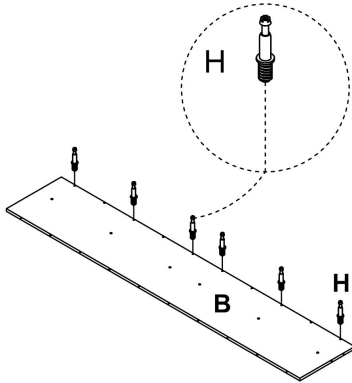

X 4

2



K x 6



G x 8

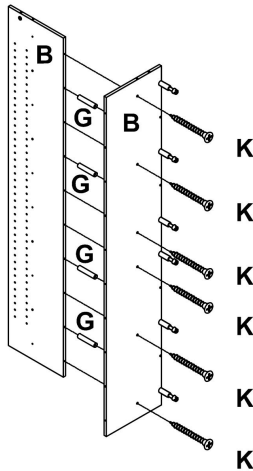

X 2

3



K x 12



G x 8

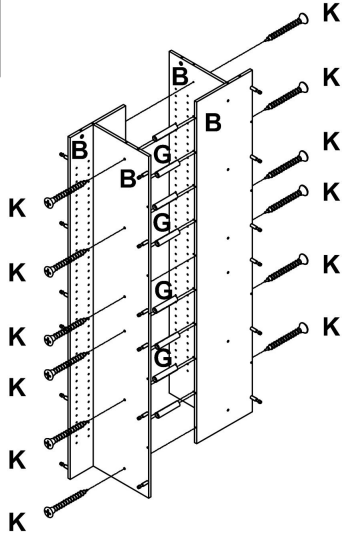

4



I x 28



G x 8

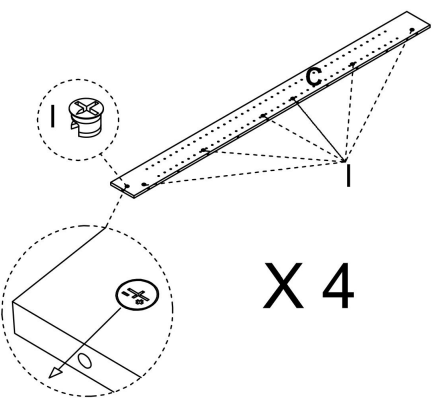
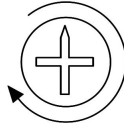

X 4

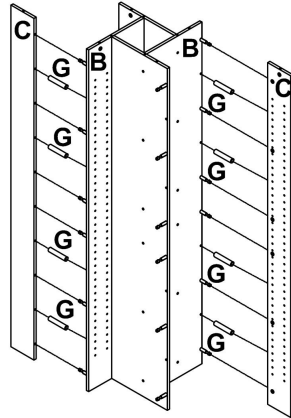

5



G x 8

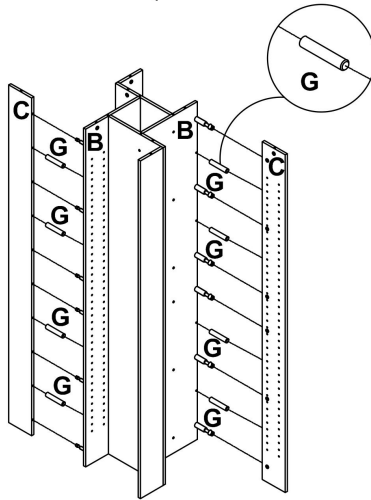
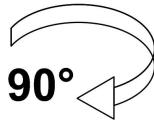
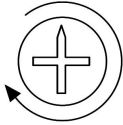

6

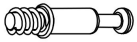

H x 8

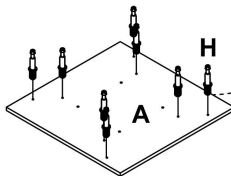
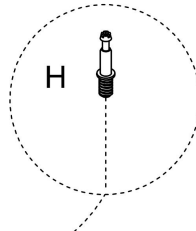

7



G x 4

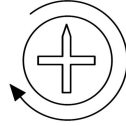
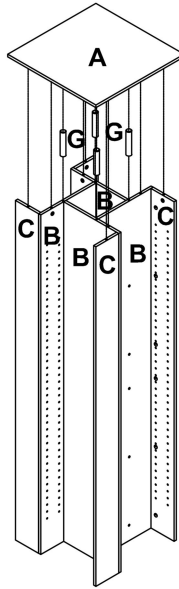

8



K x 8



G x 4

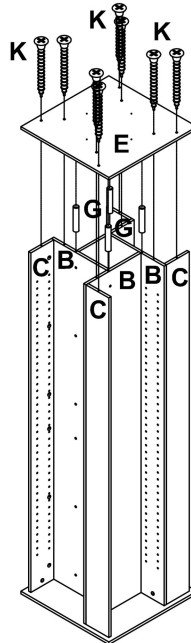

9



L x 2

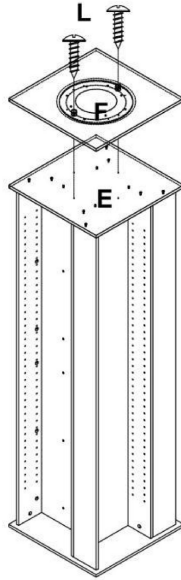

10



L x 2

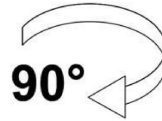
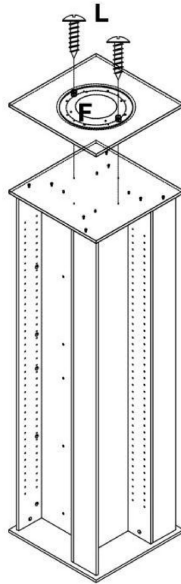

11



J x 120

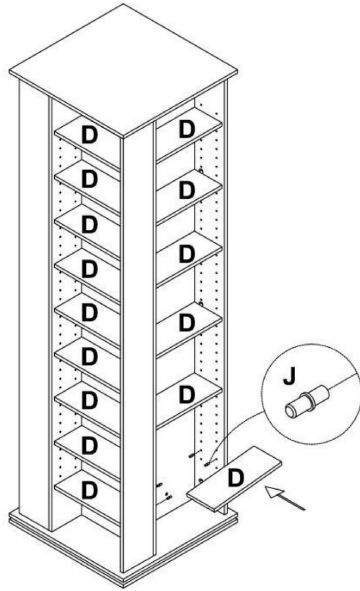

ok

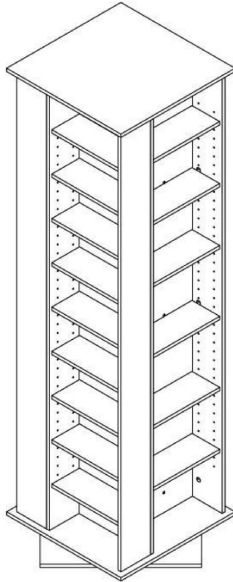

**Hersteller:** JIN WEI WOOD CO.,LTD

**Adresse:** 3# XINJU ROAD, Bezirk SHANG JIAO, STADT CHANG AN,  
STADT DONG GUAN, PROVINZ GUANGDONG, CHINA.

**Importiert nach Australien:** SIHAO PTY LTD. 1 ROKEVA STREET,  
EASTWOOD

NSW 2122 Australien

**Importiert in die USA:** Sanven Technology Ltd. Suite 250, 9166 Anaheim  
Ort, Rancho Cucamonga, CA 91730

<b>EC</b>	<b>REP</b>
-----------	------------

E-CrossStu GmbH  
Mainzer Landstr.69, 60329 Frankfurt am Main.

<b>UK</b>	<b>REP</b>
-----------	------------

YH CONSULTING LIMITED.  
C/O YH Consulting Limited Office 147, Centurion  
House, London Road, Staines-upon-Thames, Surrey,  
TW18 4AX



# **VEVOR**

**Upgrade · The Home Creator Way**

**ARCHIVIAZIONE DVD**

**MANUALE D' USO**

**N. MODELLO: USF00302, USF00301A**

**N. MODELLO: USF00302, USF00301A**

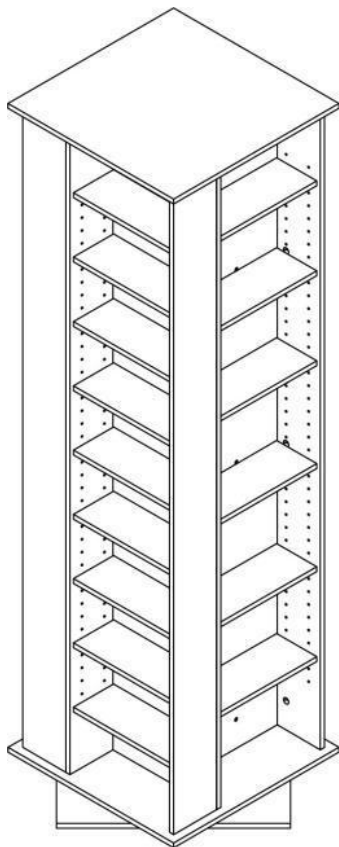

Queste sono le istruzioni originali, si prega di leggere attentamente tutte le istruzioni del manuale prima dell'uso. VEVOR si riserva la piena interpretazione del proprio manuale utente. L'aspetto del prodotto dipenderà dal prodotto ricevuto. Vi preghiamo di non informarvi più in caso di aggiornamenti tecnologici o software sul nostro prodotto.

## **AVVERTIMENTO:**

**Si prega di leggere attentamente il presente manuale prima di utilizzare il prodotto. La mancata osservanza di questa indicazione potrebbe causare gravi lesioni.**



Please read and observe carefully all the assembly instructions before beginning assembly.

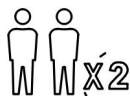

Unit should be assembled by two or more people.



**DO NOT CLIMB**

Please do not let your child climb on the product. If you have kids or animals who like to climb, we highly recommend using the wall anchors and brackets/straps that come with the package.

## **PRECAUZIONI DI MONTAGGIO**

25. Montare solo secondo queste istruzioni. Un montaggio improprio può comportare pericoli.
26. Durante il montaggio, indossare occhiali di sicurezza omologati ANSI e guanti da lavoro resistenti.
27. Mantenere l'area di assemblaggio pulita e ben illuminata.
28. Durante l'assemblea, tenere gli astanti lontani dall'area.
29. Non riunirsi quando si è stanchi o sotto l'effetto di alcol, droghe o medicinali.
30. Le capacità del prodotto si applicano solo ai prodotti correttamente e

completamente assemblati.

31. Montare su una superficie piana, orizzontale, dura e liscia, in grado di sostenere in modo sicuro l'unità di archiviazione DVD.

32. Per ulteriori informazioni sui componenti elencati nelle pagine seguenti, fare riferimento allo schema di montaggio di questo manuale. Disimballare e separare tutti i componenti in un'area di lavoro pulita.

CONSERVARE QUESTE ISTRUZIONI

## **PRECAUZIONI D'USO**

**PER PREVENIRE LESIONI GRAVI E MORTALI DOVUTE AL RIBALTAMENTO:**

13. Questo prodotto non è un giocattolo. Non permettere ai bambini di giocare con questo articolo o nelle sue vicinanze.

14. Non superare la capacità di peso prima dello spostamento.

15. Utilizzare solo su una superficie piana, dura e liscia, in grado di sostenere in modo sicuro un DVD Storage completamente caricato.

16. Utilizzare solo come previsto.

Ispezionare prima di ogni utilizzo; non utilizzare se alcune parti sono allentate o danneggiate.

## TECHNICAL SPECIFICATIONS

Modello	USF00302	USF00301A
Colore	Nero	Caffè profondo
Dimensioni del prodotto (LxPxA)(mm)	475*475*1636	
Peso netto (kg)	Circa 39,5	

\*Le specifiche, l'aspetto e il design dei prodotti sono soggetti a modifiche senza preavviso.

# PACKAGE CONTENTS

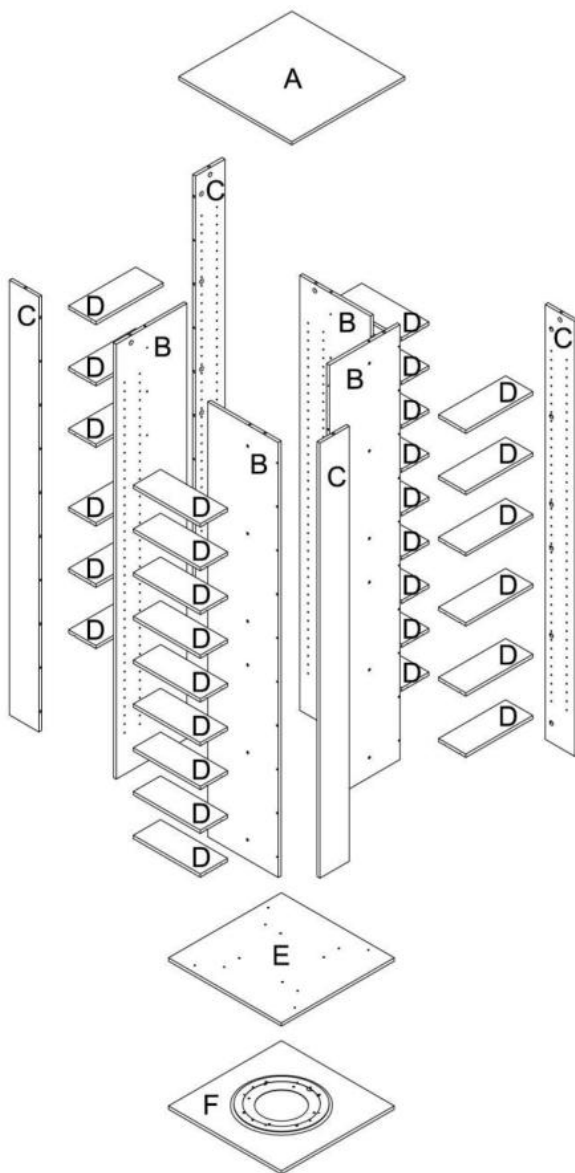

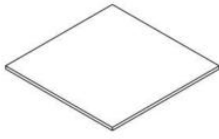

A x 1



B x 4



C x 4

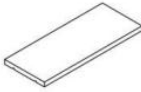

D x 30



E x 1

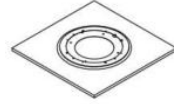

F x 1



G x 41



H x 33



I x 33



J x 121



K x 33



L x 4

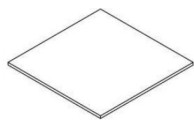

A x 1



B x 4



C x 4

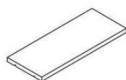

D x 30

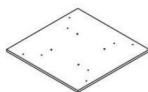

E x 1

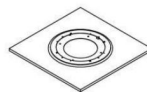

F x 1



G x 41



H x 33



I x 33



J x 121



K x 33



L x 4

Tools needed / not included

Phillips screwdriver



# ASSEMBLY STEPS

1



H x 24



I x 4

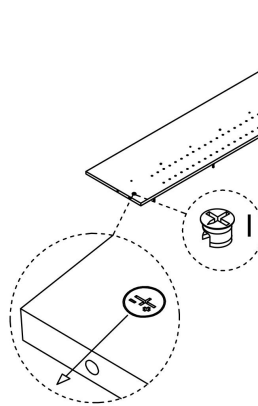
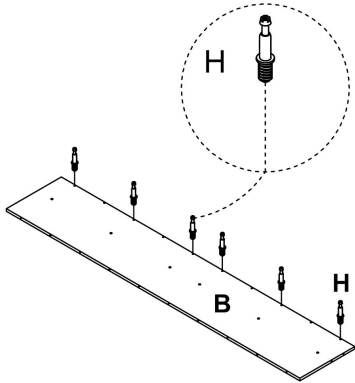

X 4

2



K x 6



G x 8

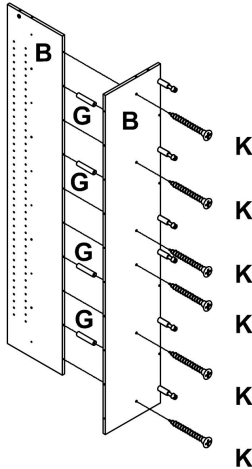

X 2

3



K x 12



G x 8

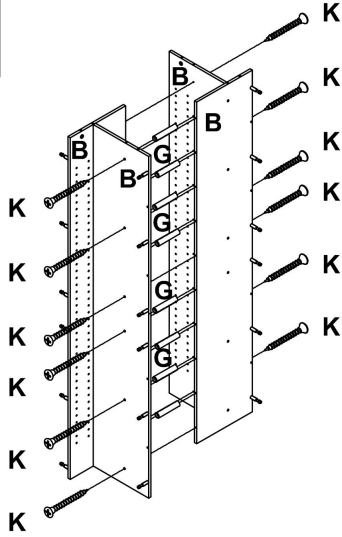

4



I x 28



G x 8

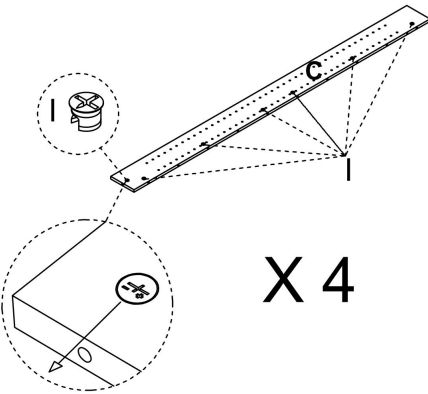
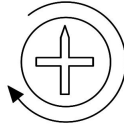

X 4

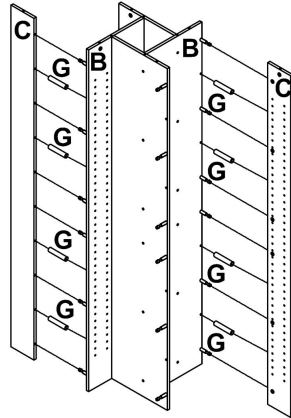

5



G x 8

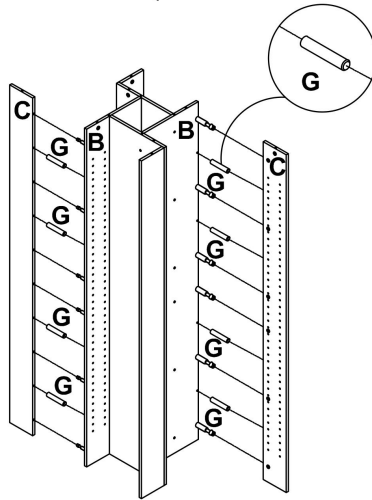
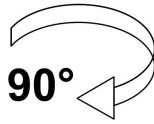
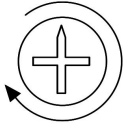

6



H x 8

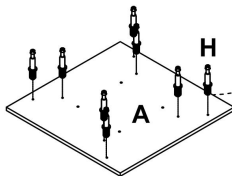
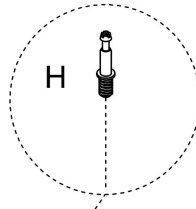

7



G x 4

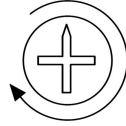
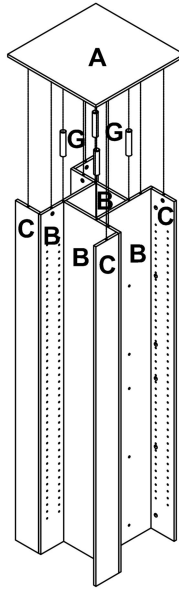

8



K x 8



G x 4

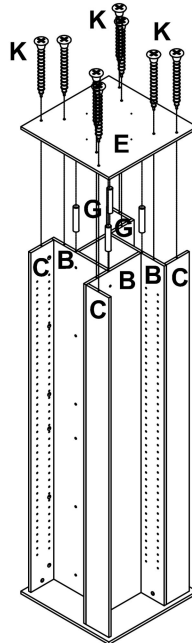

9



L x 2

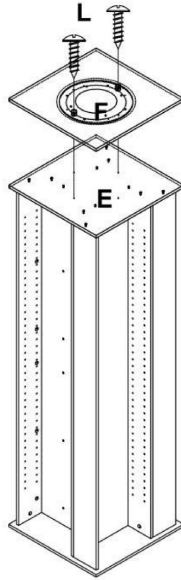

10



L x 2

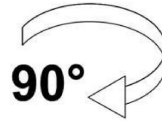
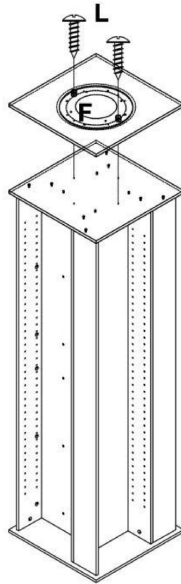

11



J x 120

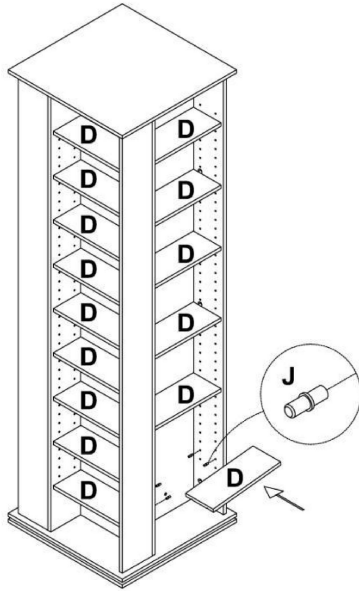

ok

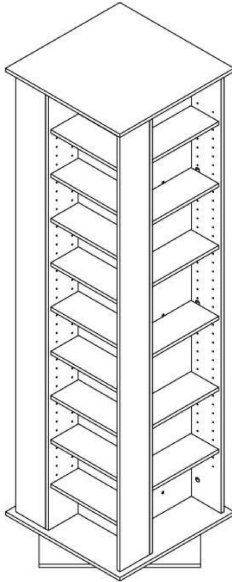

**Produttore:** JIN WEI WOOD CO.,LTD

**Indirizzo:** 3# XINJU ROAD, SHANG JIAO PRECINCT, CHANG AN TOWN,  
DONG GUAN CITY, GUANGDONGPROVINCE, CINA.

**Importato in AUS:** SIHAO PTY LTD. 1 ROKEVA STREETEASTWOOD  
Nuovo Galles del Sud 2122 Australia

**Importato negli USA:** Sanven Technology Ltd. Suite 250, 9166 Anaheim  
Luogo, Rancho Cucamonga, CA 91730

<b>EC</b>	<b>REP</b>
-----------	------------

E-CrossStu GmbH  
Mainzer Landstr.69, 60329 Frankfurt am Main.

<b>UK</b>	<b>REP</b>
-----------	------------

YH CONSULTING LIMITED.  
C/O YH Consulting Limited Office 147, Centurion  
House, London Road, Staines-upon-Thames, Surrey,  
TW18 4AX





**Upgrade · The Home Creator Way**

**ALMACENAMIENTO DE DVD**

**MANUAL DEL USUARIO**

**N.º DE MODELO: USF00302, USF00301A**

**NÚMERO DE MODELO: USF00302, USF00301A**

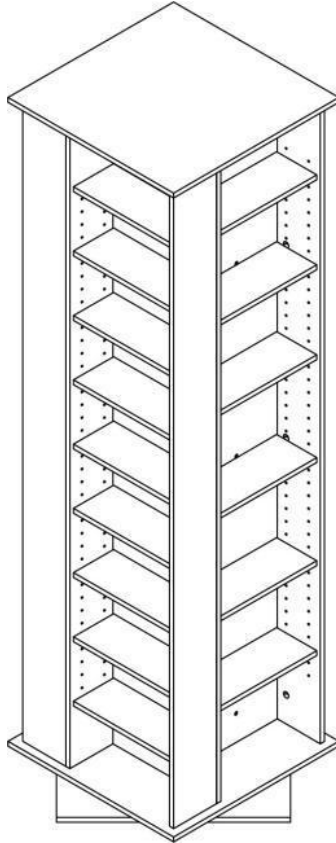

Estas son las instrucciones originales; lea atentamente todas las instrucciones del manual antes de utilizarlo. VEVOR se reserva el derecho de interpretar su manual de usuario. La apariencia del producto dependerá del producto que haya recibido. Le rogamos que nos disculpe si no le informamos de nuevo si hay actualizaciones tecnológicas o de software en nuestro producto.

 **ADVERTENCIA:**

**Lea este manual detenidamente antes de utilizar el producto. De lo contrario, podría sufrir lesiones graves.**



Please read and observe carefully all the assembly instructions before beginning assembly.

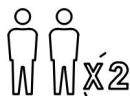

Unit should be assembled by two or more people.



DO NOT CLIMB

Please do not let your child climb on the product. If you have kids or animals who like to climb, we highly recommend using the wall anchors and brackets/straps that come with the package.

## **PRECAUCIONES DE MONTAJE**

33. Ensamble únicamente según estas instrucciones. Un montaje incorrecto puede causar peligros.
34. Use gafas de seguridad aprobadas por ANSI y guantes de trabajo resistentes durante el montaje.
35. Mantenga el área de reunión limpia y bien iluminada.
36. Mantenga a los transeúntes fuera del área durante el montaje.
37. No se reúna cuando esté cansado o bajo la influencia del alcohol, drogas o medicamentos.
38. Las capacidades del producto se aplican únicamente a productos

ensamblados de forma correcta y completa.

39. Ensamble sobre una superficie plana, nivelada, dura y lisa capaz de soportar de manera segura el almacenamiento del DVD.

40. Para obtener más información sobre las piezas que se enumeran en las siguientes páginas, consulte el diagrama de montaje de este manual. Desembale y separe todas las piezas en un área de trabajo limpia.

**GUARDE ESTAS INSTRUCCIONES**

## **PRECAUCIONES DE USO**

### **PARA EVITAR LESIONES GRAVES Y LA MUERTE POR VUELCO:**

17. Este producto no es un juguete. No permita que los niños jueguen con este artículo o cerca de él.

18. No exceda las capacidades de peso antes de moverlo.

19. Úselo únicamente sobre una superficie plana, dura y lisa capaz de soportar de forma segura un almacenamiento de DVD completamente cargado.

20. Úselo únicamente según lo previsto.

Inspeccione antes de cada uso; no lo utilice si las piezas están sueltas o dañadas.

## TECHNICAL SPECIFICATIONS

Modelo	USF00302	USF00301A
Color	Negro	Café profundo
Dimensiones del producto (Largo x Ancho x Alto) (mm)	475*475*1636	
Peso neto (kg)	Alrededor de 39,5	

\*Los productos como especificaciones, apariencia y diseño están sujetos a modificaciones sin previo aviso.

# PACKAGE CONTENTS

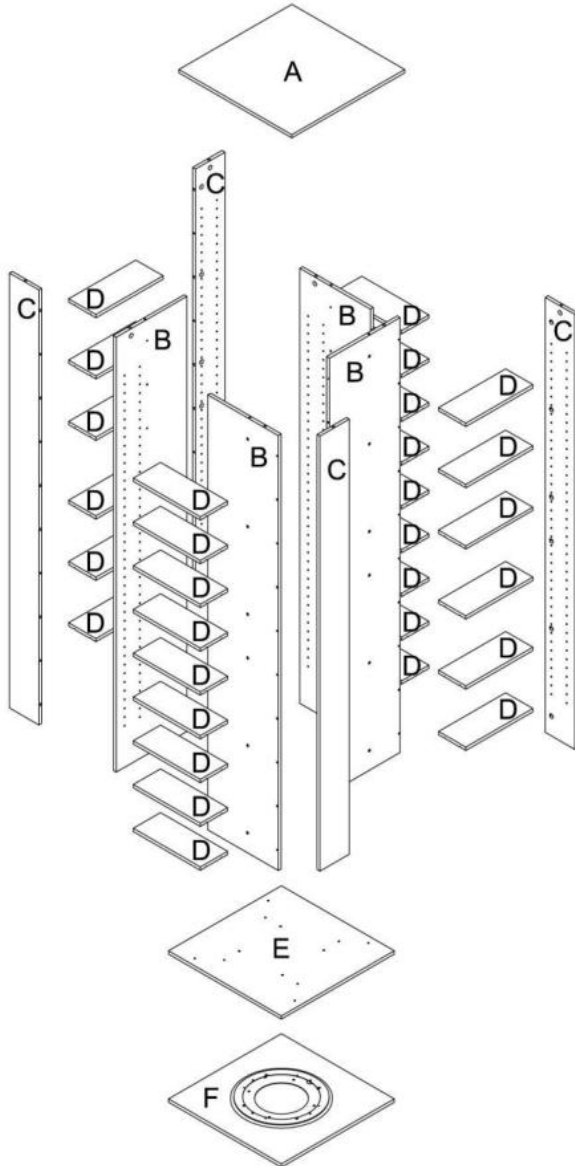

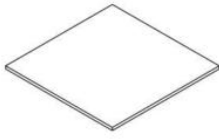

A x 1



B x 4



C x 4

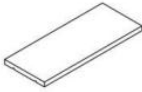

D x 30



E x 1

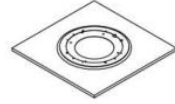

F x 1



G x 41



H x 33



I x 33



J x 121



K x 33



L x 4

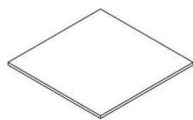

A x 1



B x 4



C x 4

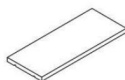

D x 30

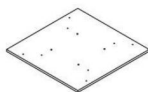

E x 1

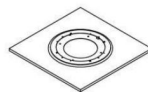

F x 1



G x 41



H x 33



I x 33



J x 121



K x 33



L x 4

### Tools needed / not included

Phillips screwdriver



# ASSEMBLY STEPS

1



H x 24



I x 4

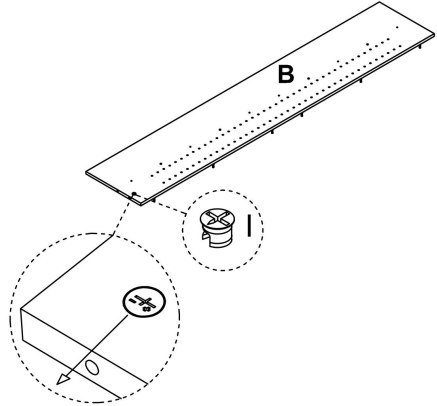
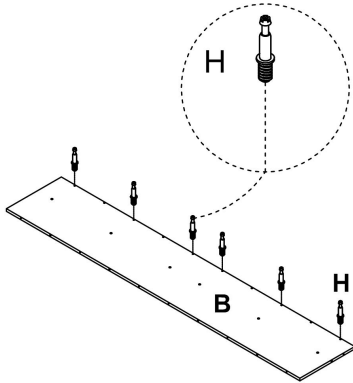

X 4

2



K x 6



G x 8

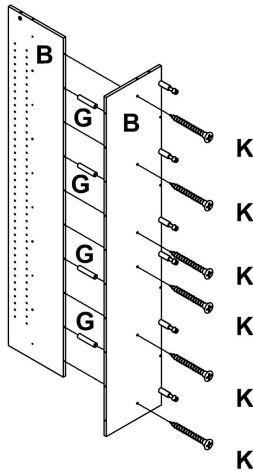

X 2

3



K x 12



G x 8

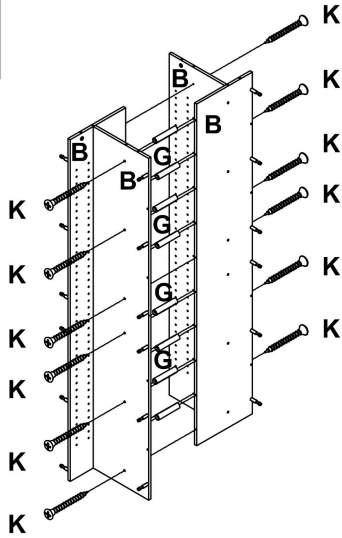

4



I x 28



G x 8

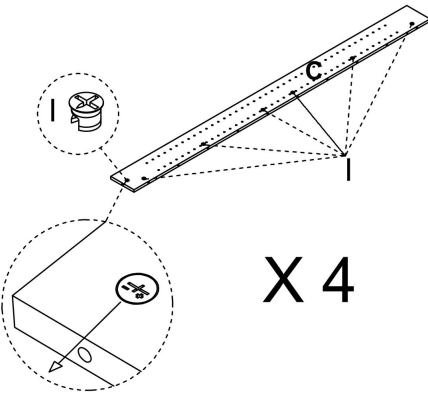
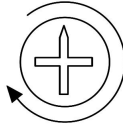

X 4

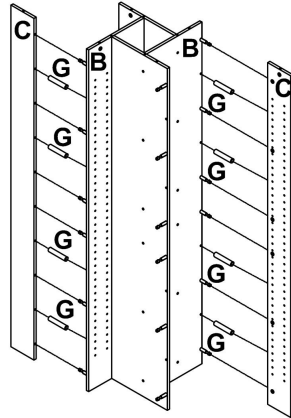

5



G x 8

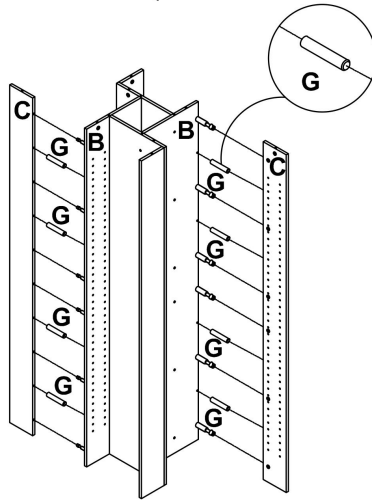
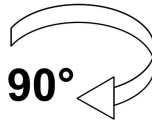
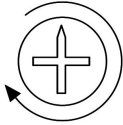

6



H x 8

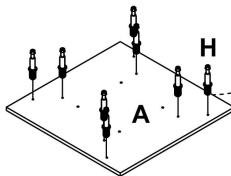
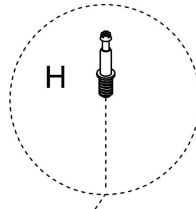

7



G x 4

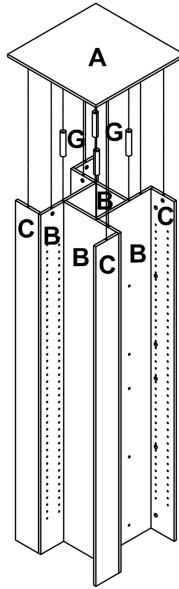

8



K x 8



G x 4

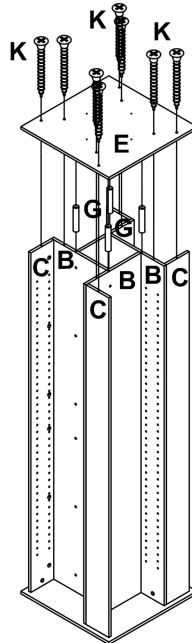

9



L x 2

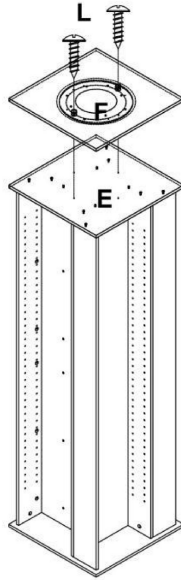

10



L x 2

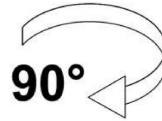
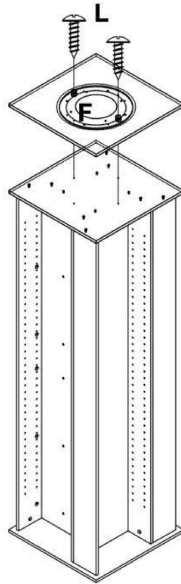

11



J x 120

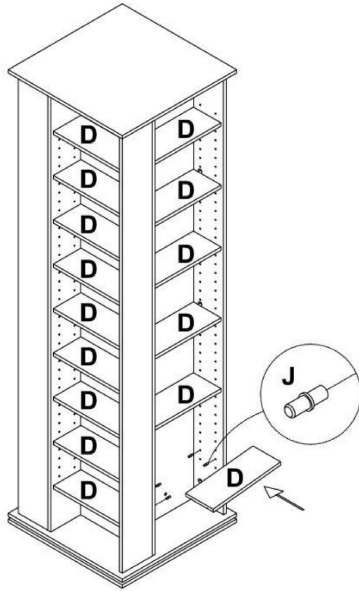

ok

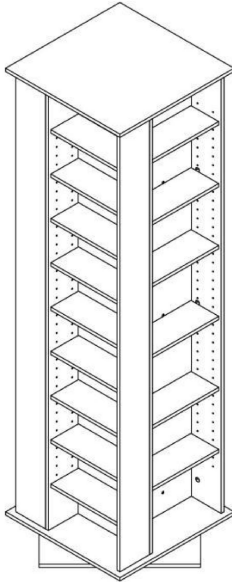

**Fabricante:** JIN WEI WOOD CO.,LTD

**Dirección:** 3# XINJU ROAD, PRECINTO DE SHANG JIAO, CIUDAD DE CHANG AN, CIUDAD DE DONG GUAN, PROVINCIA DE GUANGDONG, CHINA.

**Importado a AUS:** SIHAO PTY LTD. 1 ROKEVA STREET EASTWOOD NSW 2122 Australia

**Importado a EE. UU.:** Sanven Technology Ltd. Suite 250, 9166 Anaheim Lugar, Rancho Cucamonga, CA 91730

<b>EC</b>	<b>REP</b>
-----------	------------

E-CrossStu GmbH  
Mainzer Landstr.69, 60329 Frankfurt am Main.

<b>UK</b>	<b>REP</b>
-----------	------------

YH CONSULTING LIMITED.  
C/O YH Consulting Limited Office 147, Centurion House, London Road, Staines-upon-Thames, Surrey, TW18 4AX



# **VEVOR**

**Upgrade · The Home Creator Way**

**PRZECHOWYWANIE PŁYT DVD**

**INSTRUKCJA OBSŁUGI**

**NR MODELU: USF00302, USF00301A**

NR MODELU: USF00302, USF00301A

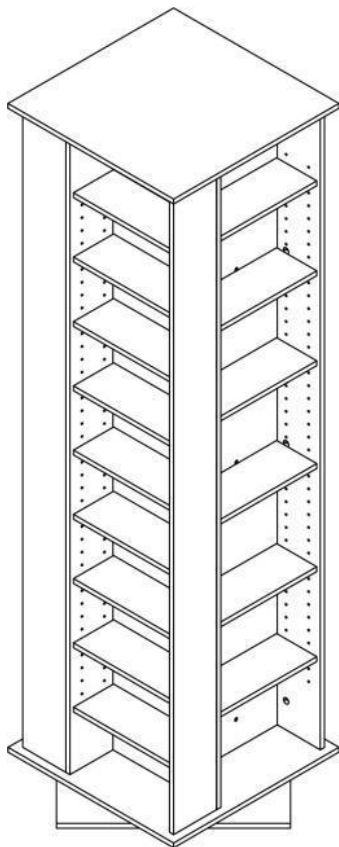

To jest oryginalna instrukcja obsługi. Przed użyciem prosimy o dokładne zapoznanie się z treścią instrukcji. Firma VEVOR zastrzega sobie prawo do jednoznacznej interpretacji niniejszej instrukcji obsługi. Wygląd produktu zależy od stanu, w jakim go otrzymali Państwo. Prosimy o wyrozumiałość, ale nie będziemy Państwa ponownie informować o aktualizacjach technologicznych lub oprogramowania naszego produktu.

## OSTRZEŻENIE:

**Przed użyciem produktu prosimy o dokładne zapoznanie się z niniejszą instrukcją. Nieprzestrzeganie jej może spowodować poważne obrażenia.**



Please read and observe carefully all the assembly instructions before beginning assembly.

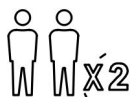

Unit should be assembled by two or more people.



DO NOT CLIMB

Please do not let your child climb on the product. If you have kids or animals who like to climb, we highly recommend using the wall anchors and brackets/straps that come with the package.

# ŚRODKI OSTROŻNOŚCI PODCZAS MONTAŻU

41. Montaż należy wykonywać wyłącznie zgodnie z niniejszą instrukcją. Nieprawidłowy montaż może stwarzać zagrożenie.
42. Podczas montażu należy nosić okulary ochronne zatwierdzone przez ANSI oraz wytrzymałe rękawice robocze.
43. Utrzymuj miejsce zgromadzenia w czystości i zapewnij dobre oświetlenie.
44. Nie dopuszczać osób postronnych na teren montażu w trakcie jego trwania.

45. Nie należy gromadzić się, gdy jest się zmęczonym lub pod wpływem alkoholu, narkotyków lub leków.
46. Możliwości produktu odnoszą się wyłącznie do produktów prawidłowo i całkowicie zmontowanych.
47. Złóż na płaskiej, równej, twardej i gładkiej powierzchni, która będzie w stanie bezpiecznie utrzymać pojemnik na płyty DVD.
48. Aby uzyskać dodatkowe informacje dotyczące części wymienionych na kolejnych stronach, zapoznaj się ze schematem montażu w niniejszej instrukcji. Rozpakuj i oddziel wszystkie części w czystym miejscu pracy.

ZAPISZ TE INSTRUKCJE

## **ŚRODKI OSTROŻNOŚCI**

**ABY ZAPOBIEC POWAŻNYM OBRAŻENIOM I ŚMIERCI  
SPOWODOWANEJ PRZEWRÓCENIEM:**

21. Ten produkt nie jest zabawką. Nie pozwalaj dzieciom bawić się tym przedmiotem ani przebywać w jego pobliżu.
22. Przed przeprowadzką nie przekraczaj dopuszczalnego ciężaru.
23. Używaj wyłącznie na płaskiej, twardej i gładkiej powierzchni, która będzie w stanie bezpiecznie utrzymać w pełni załadowaną płytę DVD.
24. Stosować wyłącznie zgodnie z przeznaczeniem.  
Przed każdym użyciem należy przeprowadzić kontrolę. Nie używać produktu, jeśli części są luźne lub uszkodzone.

## TECHNICAL SPECIFICATIONS

Model	USF00302	USF00301A
Kolor	Czarny	Głęboka kawa
Wymiary produktu (Dł. x Szer. x Wys.) (mm)	475*475*1636	
Masa netto (kg)	Okolo 39,5	

\*Specyfikacje, wygląd i konstrukcja produktów mogą ulec zmianie bez wcześniejszego powiadomienia.

## **PACKAGE CONTENTS**

---

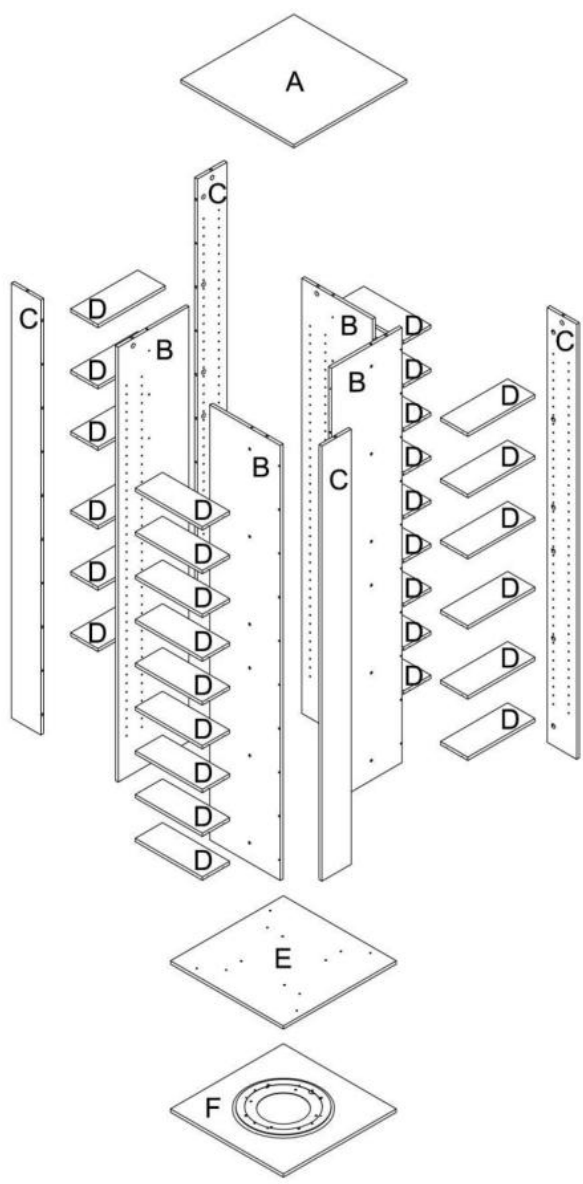

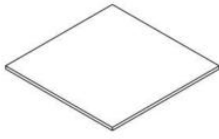

A x 1



B x 4



C x 4

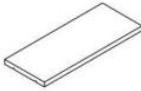

D x 30



E x 1

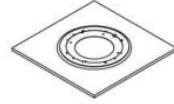

F x 1



G x 41



H x 33



I x 33



J x 121



K x 33



L x 4

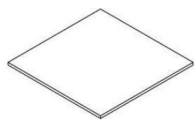

A x 1



B x 4



C x 4

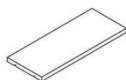

D x 30

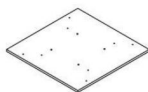

E x 1

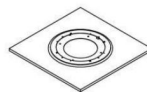

F x 1



G x 41



H x 33



I x 33



J x 121



K x 33



L x 4

### Tools needed / not included

Phillips screwdriver



# ASSEMBLY STEPS

1



H x 24



I x 4

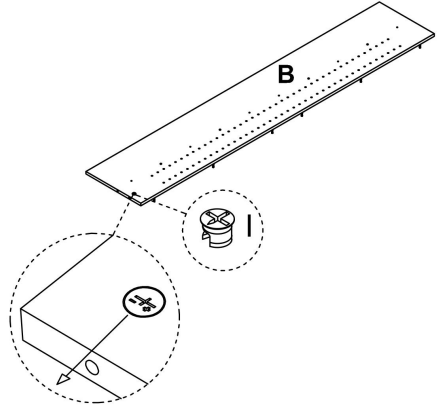
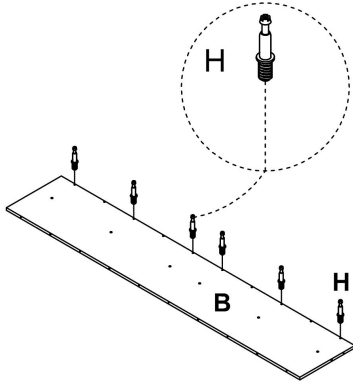

X 4

2



K x 6



G x 8

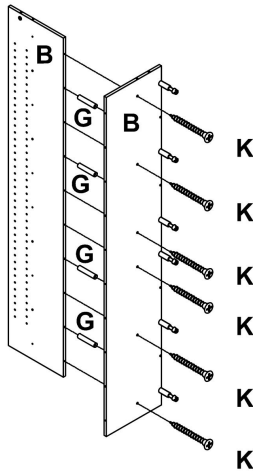

X 2

3



K x 12



G x 8

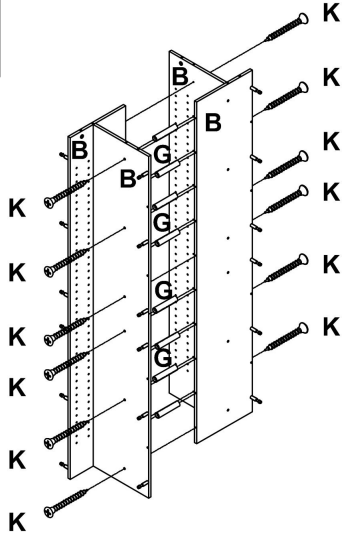

4



I x 28



G x 8

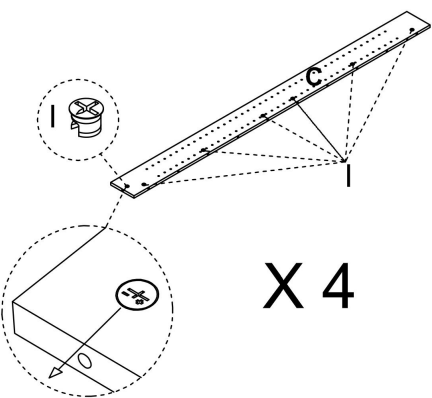
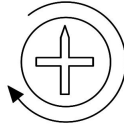

X 4

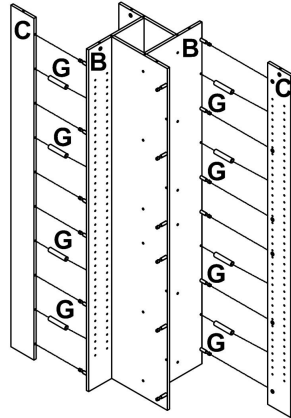

5



G x 8

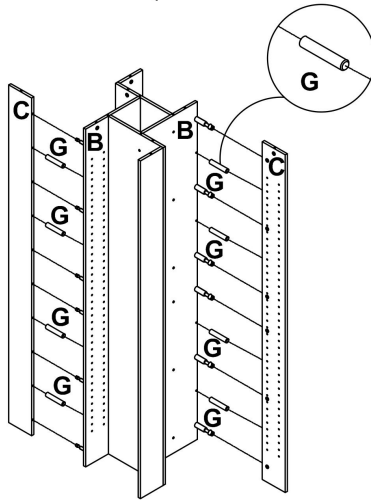
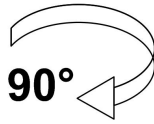
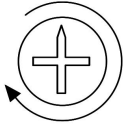

6



H x 8

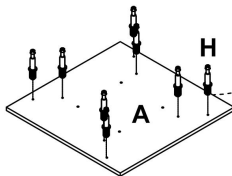
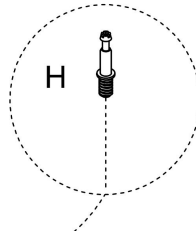

7



G x 4

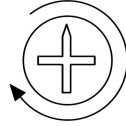
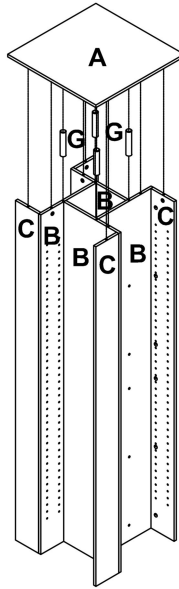

8



K x 8



G x 4

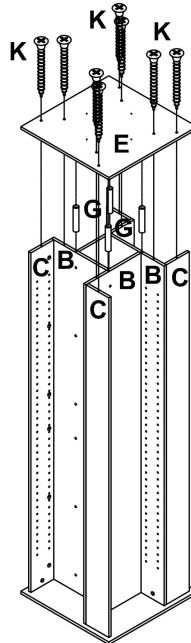

9



L x 2

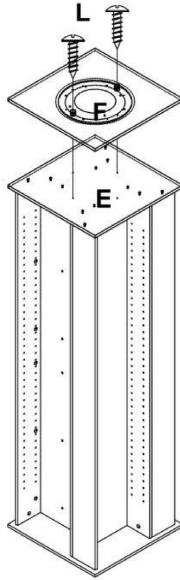

10



L x 2

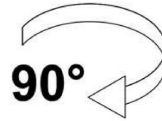
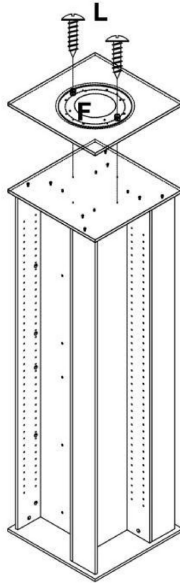

11



J x 120

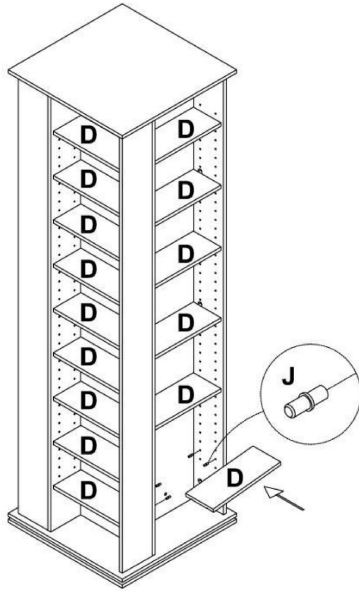

ok

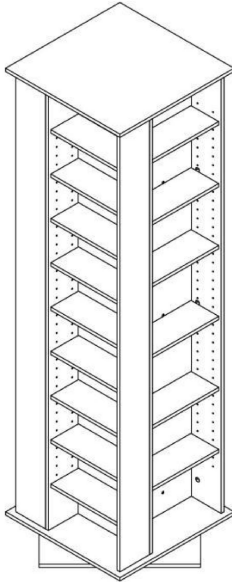

**Producent:** JIN WEI WOOD CO.,LTD

**Adres:** 3# XINJU ROAD, SHANG JIAO RECINCT, CHANG AN MIASTO,  
MIASTO DONG GUAN, PROWINCJA GUANGDONG, CHINY.

**Importowane do AUS:** SIHAO PTY LTD. 1 ROKEVA  
STREETEASTWOOD

NSW 2122 Australia

**Importowane do USA:** Sanven Technology Ltd. Suite 250, 9166 Anaheim  
Miejsce, Rancho Cucamonga, CA 91730

<b>EC</b>	<b>REP</b>
-----------	------------

E-CrossStu GmbH  
Mainzer Landstr.69, 60329 Frankfurt am Main.

<b>UK</b>	<b>REP</b>
-----------	------------

YH CONSULTING LIMITED.  
C/O YH Consulting Limited Office 147, Centurion  
House, London Road, Staines-upon-Thames, Surrey,  
TW18 4AX



# **VEVOR**

**Upgrade · The Home Creator Way**

**DVD-OPSLAG**

**GEBRUIKERSHANDLEIDING**

**MODELNUMMER: USF00302, USF00301A**

# VEVOR

Upgrade · The Home Creator Way

## DVD Storage

**MODELNUMMER: USF00302, USF00301A**

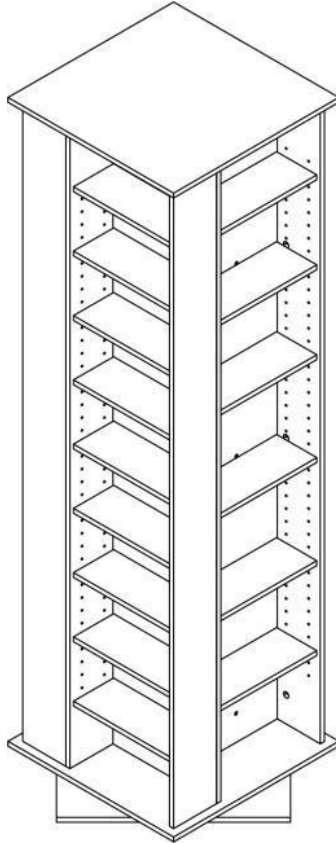

Dit is de originele handleiding. Lees alle instructies in de handleiding zorgvuldig door voordat u het product in gebruik neemt. VEVOR behoudt zich het recht voor om de gebruikershandleiding anders te interpreteren. Het uiterlijk van het product kan afwijken van het product dat u ontvangt. Wij zullen u niet opnieuw informeren over eventuele technologische of software-updates voor ons product.

## **WAARSCHUWING:**

**Lees deze handleiding aandachtig door voordat u het product gebruikt. Het niet nalezen van deze handleiding kan ernstig letsel tot gevolg hebben.**



Please read and observe carefully all the assembly instructions before beginning assembly.

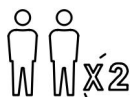

Unit should be assembled by two or more people.



**DO NOT CLIMB**

Please do not let your child climb on the product. If you have kids or animals who like to climb, we highly recommend using the wall anchors and brackets/straps that come with the package.

# **VOORZORGSMATREGELEN BIJ MONTAGE**

49. Monteer het product uitsluitend volgens deze instructies. Onjuiste montage kan gevaarlijke situaties veroorzaken.
50. Draag tijdens de montage een ANSI-goedgekeurde veiligheidsbril en stevige werkhandschoenen.
51. Zorg ervoor dat de montageruimte schoon en goed verlicht is.
52. Houd omstanders uit de buurt tijdens de bijeenkomst.
53. Monteer de onderdelen niet wanneer u moe bent of onder invloed bent

van alcohol, drugs of medicijnen.

54. De producteigenschappen gelden alleen voor correct en volledig geassembleerde producten.

55. Monteer de dvd-opslag op een vlakke, horizontale, harde en gladde ondergrond die deze veilig kan dragen.

56. Raadpleeg voor meer informatie over de onderdelen die op de volgende pagina's worden vermeld, het montageschema in deze handleiding. Pak alle onderdelen uit en sorteer ze in een schone werkruimte.

BEWAAR DEZE INSTRUCTIES

## **NEEM DE VOORZORGSMAATREGELEN IN ACHT**

**OM ERNSTIG LETSEL EN OVERLIJDEN DOOR OMKANTELEN TE  
VOORKOMEN:**

25. Dit product is geen speelgoed. Laat kinderen niet met dit product spelen of in de buurt ervan komen.

26. Overschrijd de maximale gewichtslimieten niet voordat u gaat verplaatsen.

27. Gebruik het apparaat alleen op een vlakke, harde en gladde ondergrond die een volledig gevulde dvd-opslag veilig kan dragen.

28. Gebruik uitsluitend zoals bedoeld.

Controleer het product voor elk gebruik; gebruik het product niet als onderdelen loszitten of beschadigd zijn.

## TECHNICAL SPECIFICATIONS

Model	USF00302	USF00301A
Kleur	Zwart	Diepe koffie
Productafmetingen (LxBxH)(mm)	475*475*1636	
Nettogewicht (kg)	Ongeveer 39,5	

\*Productspecificaties, uiterlijk en ontwerp kunnen zonder voorafgaande kennisgeving worden gewijzigd.

## **PACKAGE CONTENTS**

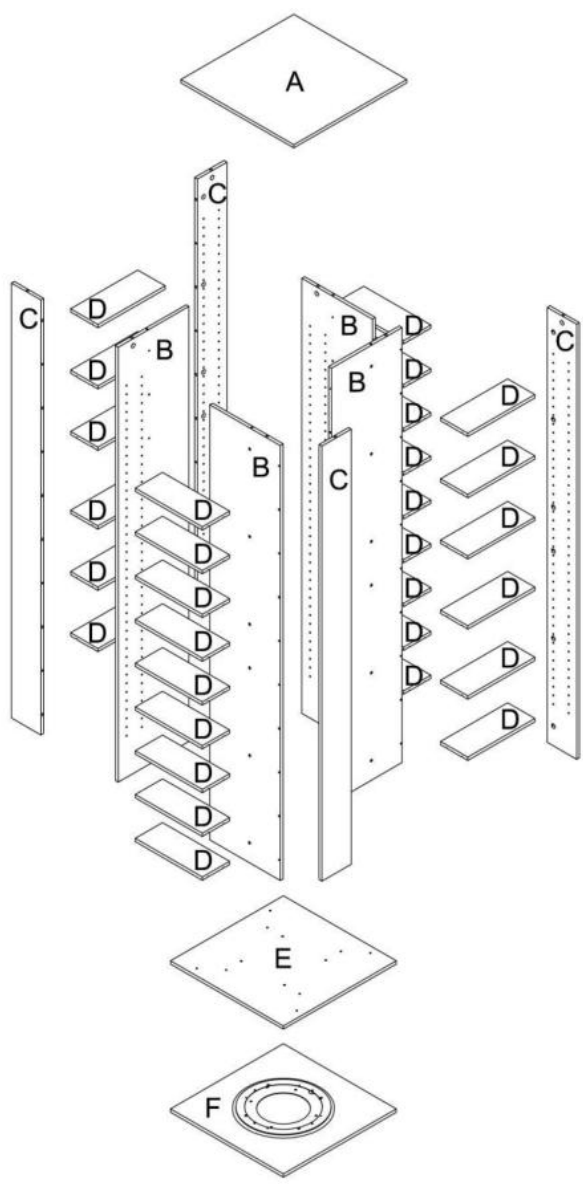

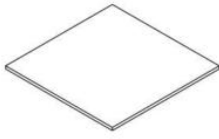

A x 1



B x 4



C x 4

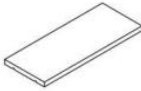

D x 30



E x 1

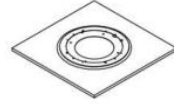

F x 1



G x 41



H x 33



I x 33



J x 121



K x 33



L x 4

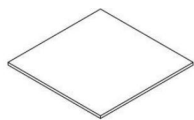

A x 1



B x 4



C x 4

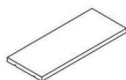

D x 30

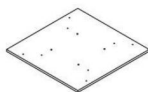

E x 1

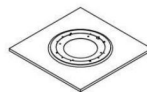

F x 1



G x 41



H x 33



I x 33



J x 121



K x 33



L x 4

### Tools needed / not included

Phillips screwdriver



# ASSEMBLY STEPS

**1**



**H x 24**



**I x 4**

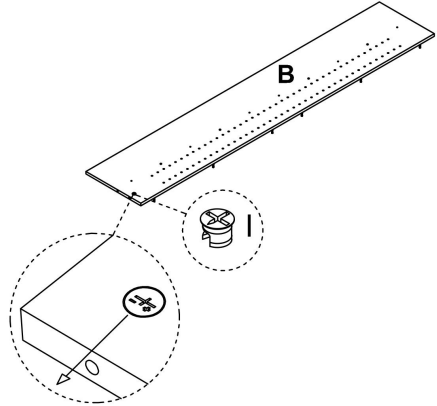
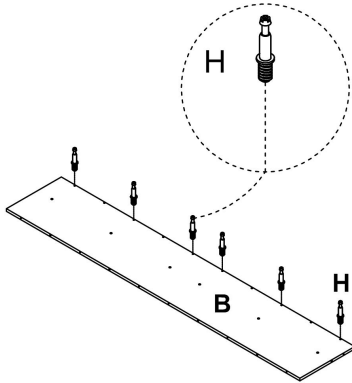

**X 4**

**2**



**K x 6**



**G x 8**

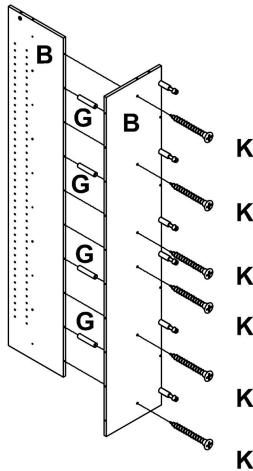

**X 2**

3



K x 12



G x 8

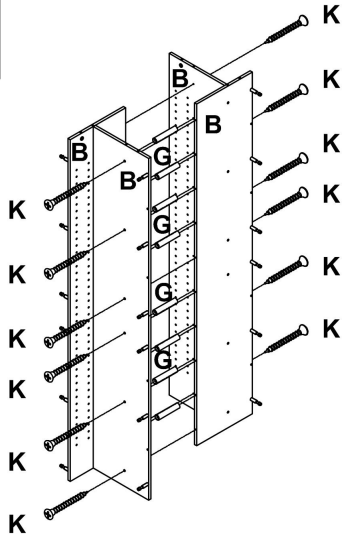

4



I x 28



G x 8

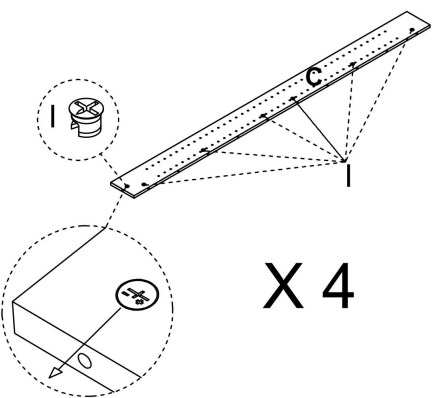
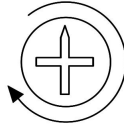

X 4

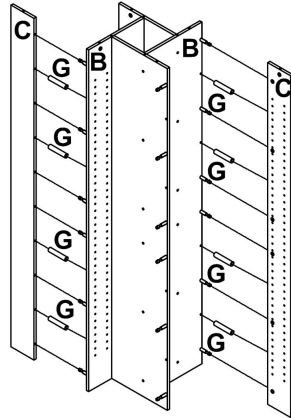

5



G x 8

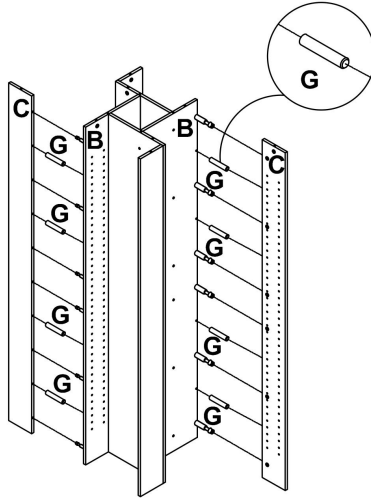
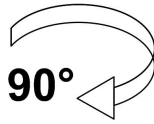
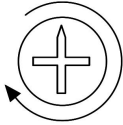

6

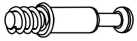

H x 8

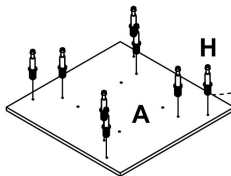
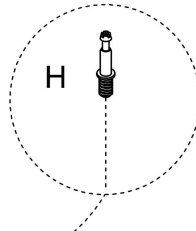

7



G x 4

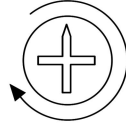
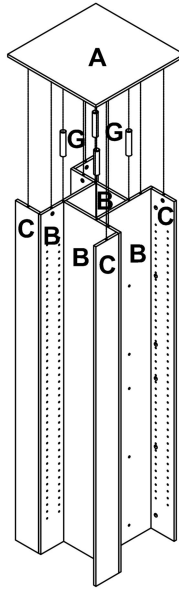

8



K x 8



G x 4

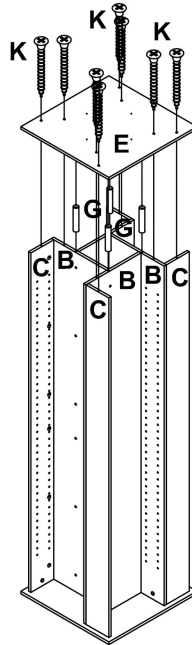

9



L x 2

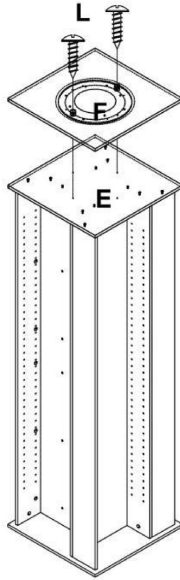

10



L x 2

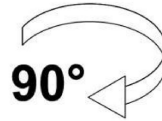
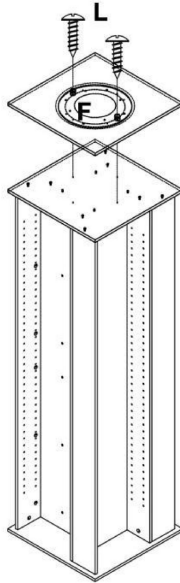

11



J x 120

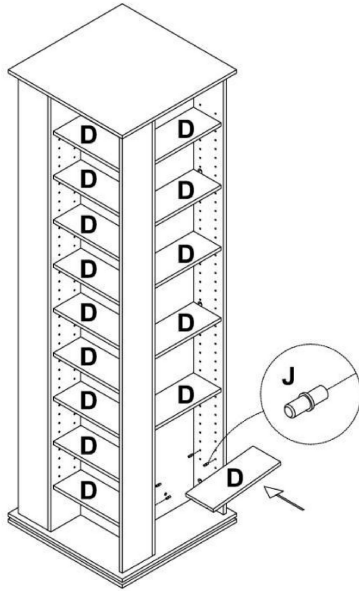

ok

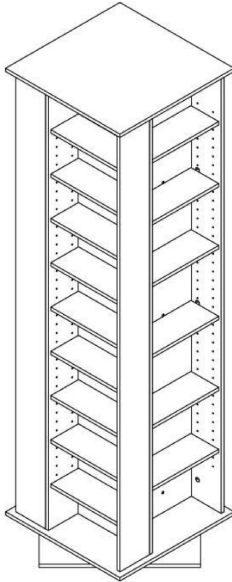

**Fabrikant:** JIN WEI WOOD CO.,LTD

**Adres:** 3# XINJU ROAD, SHANG JIAO PRECINCT, CHANG AN TOWN,  
DONG GUAN CITY, GUANGDONGPROVINCE, CHINA.

**Geïmporteerd naar Australië:** SIHAO PTY LTD. 1 ROKEVA STREET  
EASTWOOD

NSW 2122 Australië

**Geïmporteerd naar de VS:** Sanven Technology Ltd. Suite 250, 9166  
Anaheim

Plaats, Rancho Cucamonga, CA 91730

<b>EC</b>	<b>REP</b>
-----------	------------

E-CrossStu GmbH  
Mainzer Landstr.69, 60329 Frankfurt am Main.

<b>UK</b>	<b>REP</b>
-----------	------------

YH CONSULTING LIMITED.  
C/O YH Consulting Limited Office 147, Centurion  
House, London Road, Staines-upon-Thames, Surrey,  
TW18 4AX



# **VEVOR**

**Upgrade · The Home Creator Way**

**DVD-LAGRING**

**ANVÄNDARMANUAL**

**MODELLNR.: USF00302, USF00301A**

MODELL NR.: USF00302, USF00301A

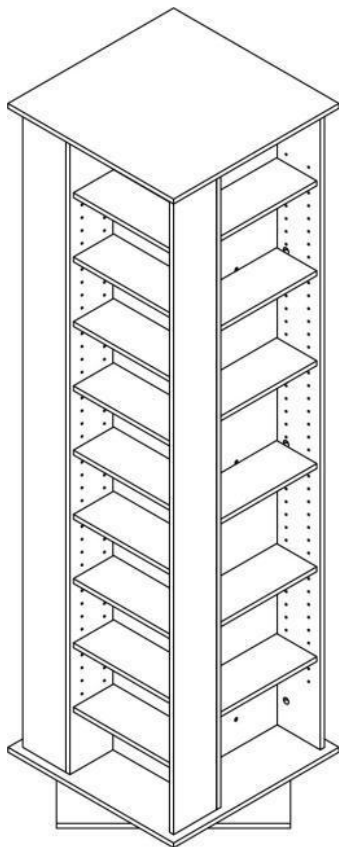

Detta är originalinstruktionerna, vänligen läs alla instruktioner noggrant innan du använder produkten. VEVOR förbehåller sig en tydlig tolkning av vår användarmanual. Produktens utseende ska vara beroende av den produkt du mottagit. Vi ber om ursäkt för att vi inte kommer att informera dig igen om det finns några teknik- eller programuppdateringar för vår produkt.

 **WARNING:**

**Läs noggrant igenom denna manual innan du använder produkten. Underlåtenhet att göra det kan leda till allvarliga skador.**



Please read and observe carefully all the assembly instructions before beginning assembly.

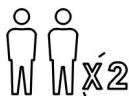

Unit should be assembled by two or more people.



DO NOT CLIMB

Please do not let your child climb on the product. If you have kids or animals who like to climb, we highly recommend using the wall anchors and brackets/straps that come with the package.

## **FÖRSIKTIGHETSÅTGÄRDER VID MONTERING**

57. Montera endast enligt dessa instruktioner. Felaktig montering kan skapa risker.
58. Använd ANSI-godkända skyddsglasögon och kraftiga arbetshandskar under monteringen.
59. Håll samlingsområdet rent och väl upplyst.
60. Håll åskådare borta från området under monteringen.
61. Montera inte när du är trött eller påverkad av alkohol, droger eller mediciner.

62. Produktegenskaperna gäller endast korrekt och fullständigt monterade produkter.

63. Montera på en plan, jämn, hård och slät yta som säkert kan bära DVD-förvaringen.

64. För ytterligare information om delarna som listas på följande sidor, se monterings-schemat i denna manual. Packa upp och separera alla delar på en ren arbetsyta.

SPARA DESSA INSTRUKTIONER

## **ANVÄND FÖRSIKTIGHETSÅTGÄRDER**

**FÖR ATT FÖRHINDRA ALLVARLIGA SKADOR OCH DÖDSFALL  
GENOM TIPPNING:**

29. Denna produkt är inte en leksak. Låt inte barn leka med eller i närheten av denna produkt.

30. Överskrid inte viktkapaciteten före flyttning.

31. Använd endast på en plan, hård och slät yta som säkert kan bära en fulladdad DVD-lagring.

32. Använd endast som avsett.

Kontrollera före varje användning; använd inte om delar är lösa eller skadade.

## TECHNICAL SPECIFICATIONS

Modell	USF00302	USF00301A
Färg	Svart	Djup kaffe
Produktmått (LxBxH)(mm)	475*475*1636	
Nettovikt (kg)	Cirka 39,5	

\*Produkter såsom specifikationer, utseende och design kan komma att ändras utan föregående meddelande.

## **PACKAGE CONTENTS**

---

---

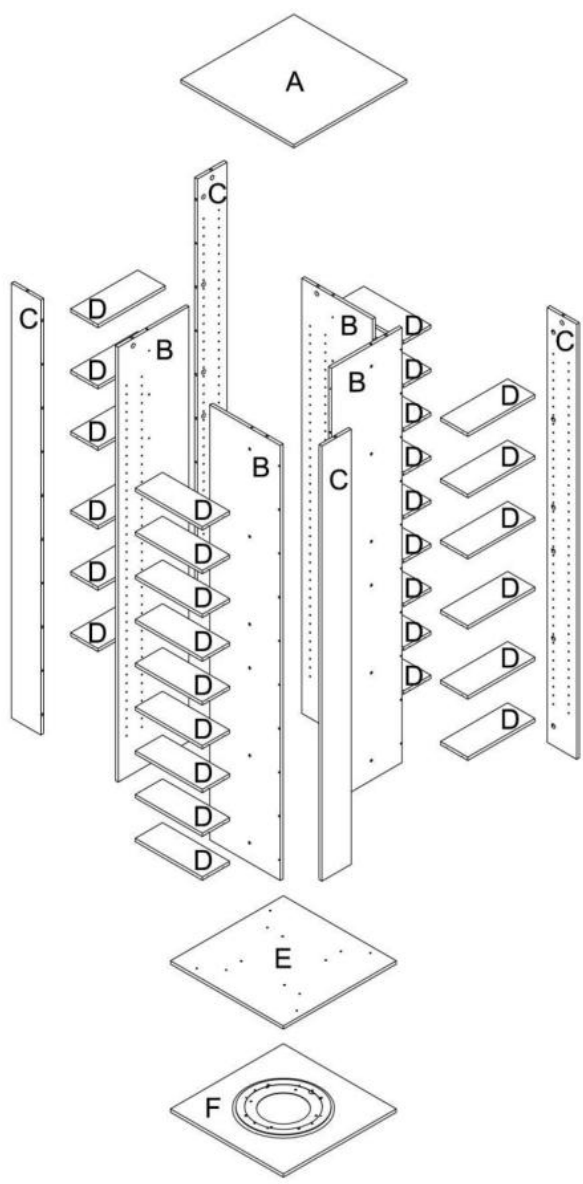

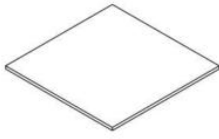

A x 1



B x 4



C x 4

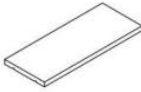

D x 30



E x 1

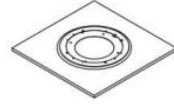

F x 1



G x 41



H x 33



I x 33



J x 121



K x 33



L x 4

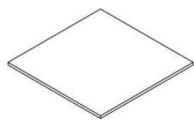

A x 1



B x 4



C x 4

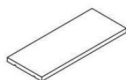

D x 30

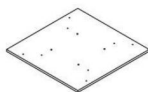

E x 1

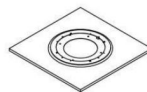

F x 1



G x 41



H x 33



I x 33



J x 121



K x 33



L x 4

### Tools needed / not included

Phillips screwdriver



# ASSEMBLY STEPS

**1**



**H x 24**



**I x 4**

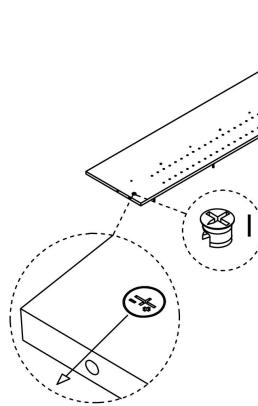
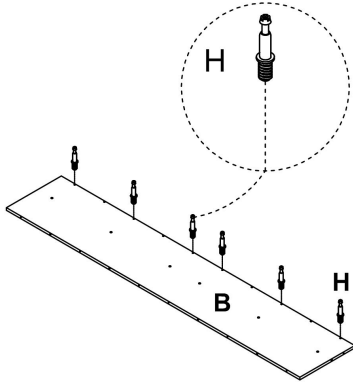

**X 4**

**2**



**K x 6**



**G x 8**

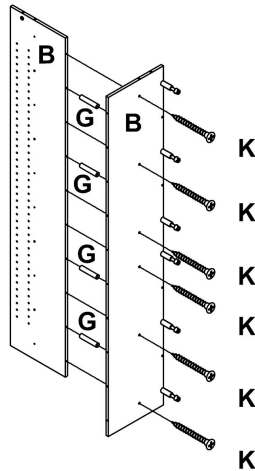

**X 2**

3



K x 12



G x 8

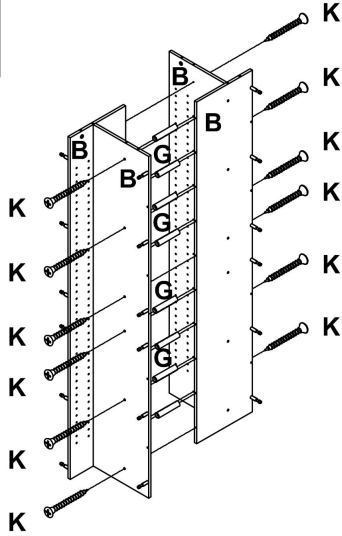

4



I x 28



G x 8

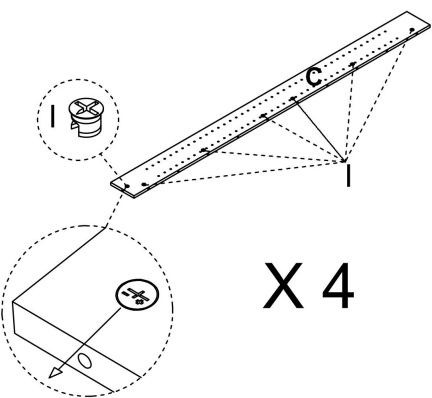
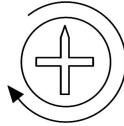

X 4

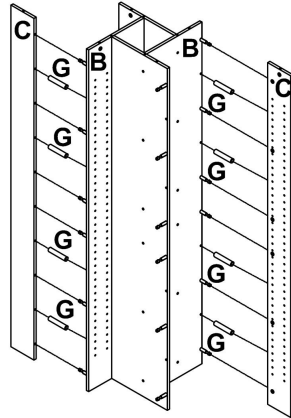

5



G x 8

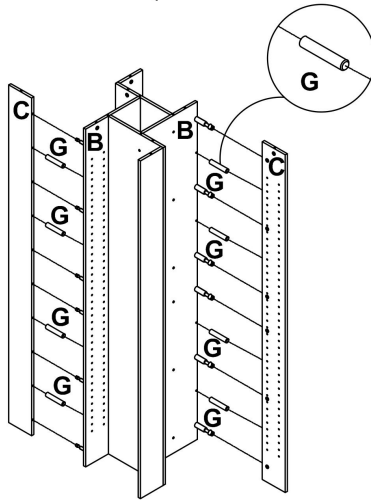
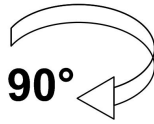
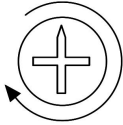

6

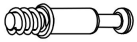

H x 8

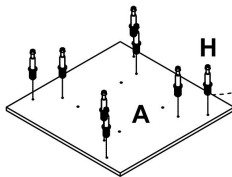
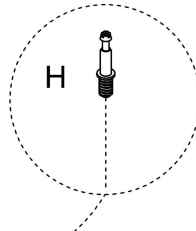

7



G x 4

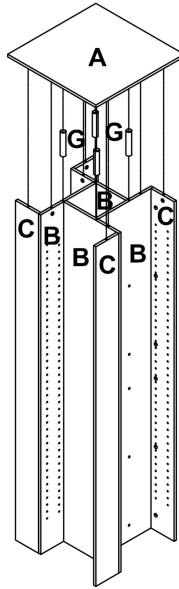

8



K x 8



G x 4

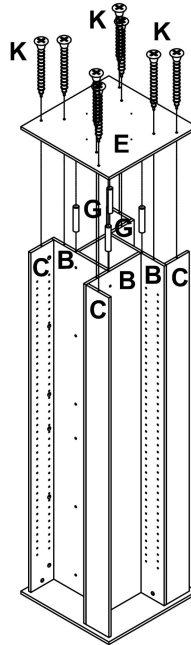

9



L x 2

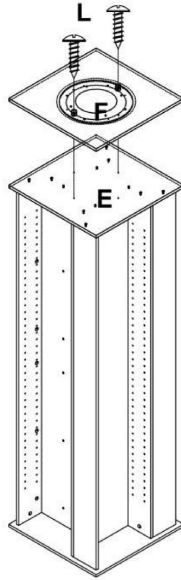

10



L x 2

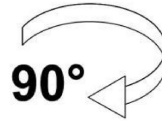
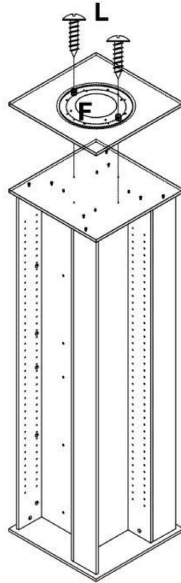

11



J x 120

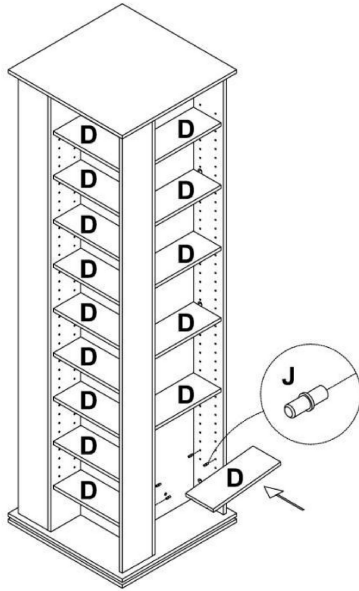

ok

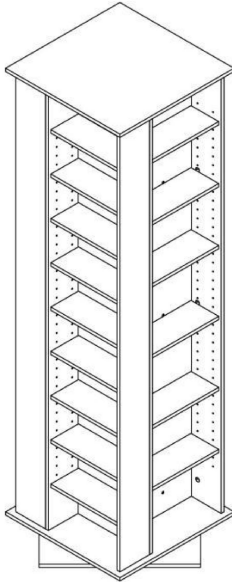

**Tillverkare:** JIN WEI WOOD CO.,LTD

**Adress:** 3# XINJU ROAD, SHANG JIAO PRECINCT, CHANG AN TOWN,  
DONG GUAN CITY, GUANGDONGPROVINCE, KINA.

**Importerad till Australien:** SIHAO PTY LTD. 1 ROKEVA  
STREETEASTWOOD

NSW 2122 Australien

**Importerad till USA:** Sanven Technology Ltd. Suite 250, 9166 Anaheim  
Plats, Rancho Cucamonga, Kalifornien 91730

<b>EC</b>	<b>REP</b>
-----------	------------

E-CrossStu GmbH  
Mainzer Landstr.69, 60329 Frankfurt am Main.

<b>UK</b>	<b>REP</b>
-----------	------------

YH CONSULTING LIMITED.  
C/O YH Consulting Limited Office 147, Centurion  
House, London Road, Staines-upon-Thames, Surrey,  
TW18 4AX

