

Assembly Instruction Sheet for Model HL403767

Package Contents

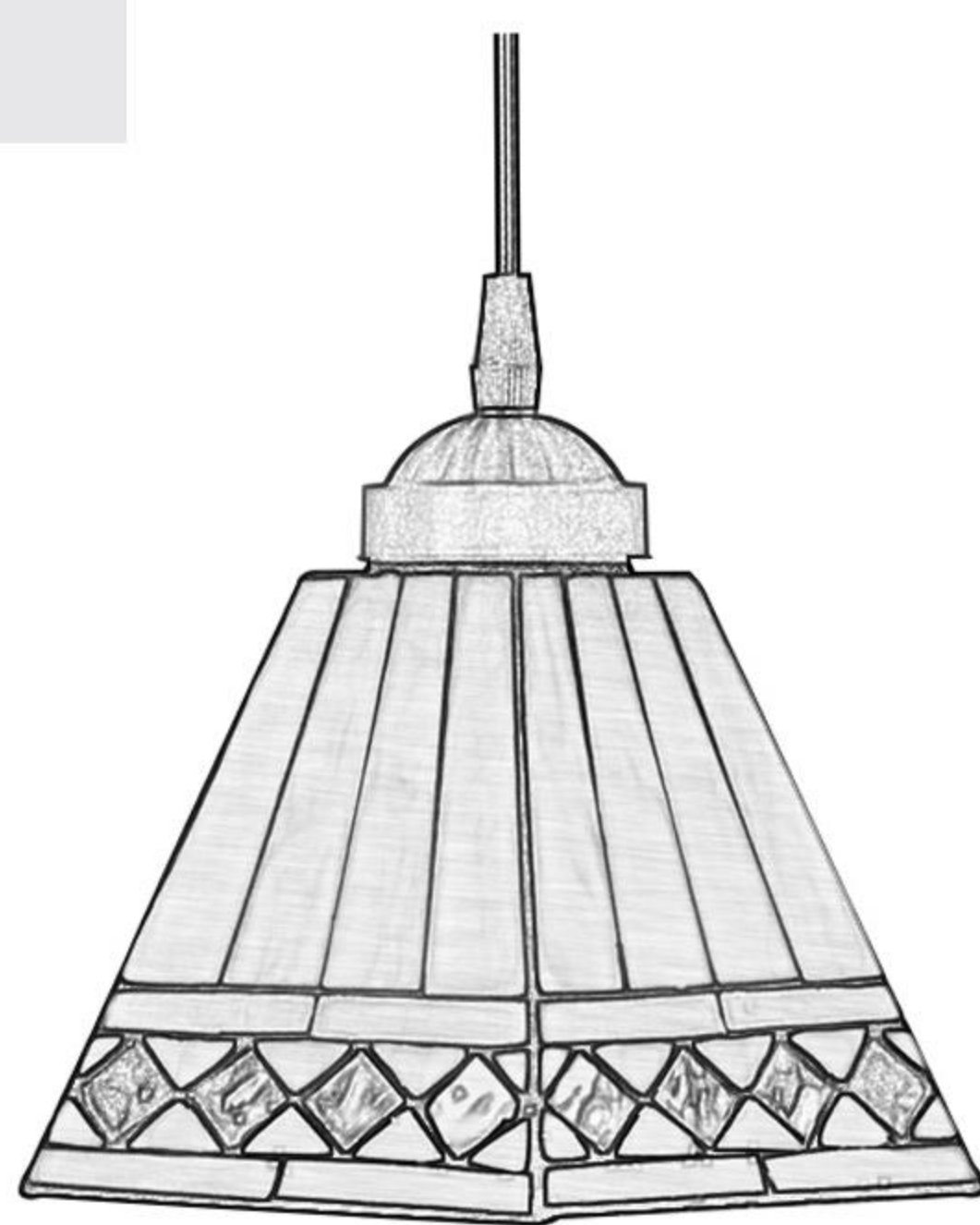

STEP 1

1. Mark the location on the ceiling with the hanging plate as a reference, and then drill holes on the ceiling.

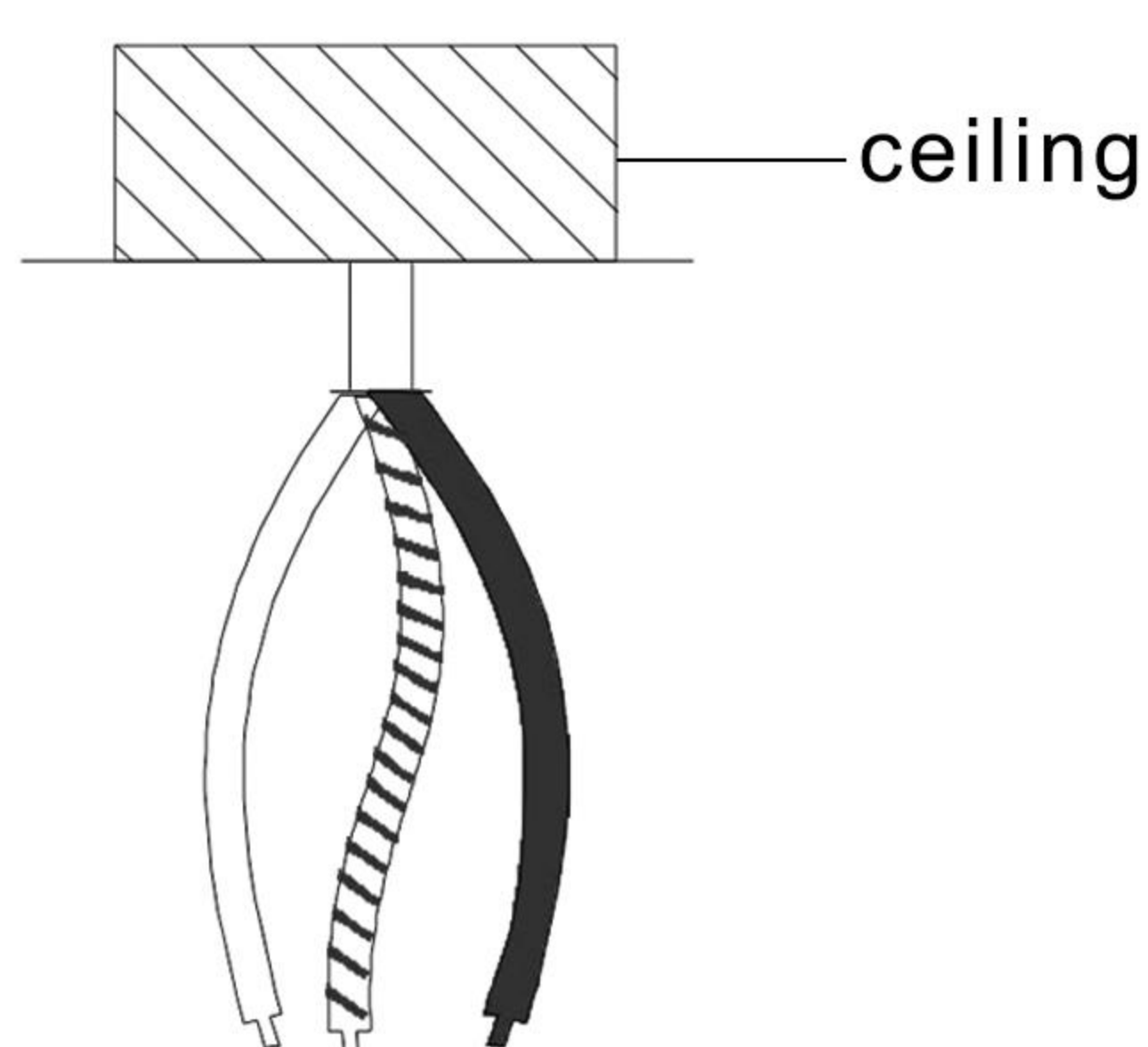

STEP 2

2. Use the mounting screws to attach the mounting plate onto the ceiling.

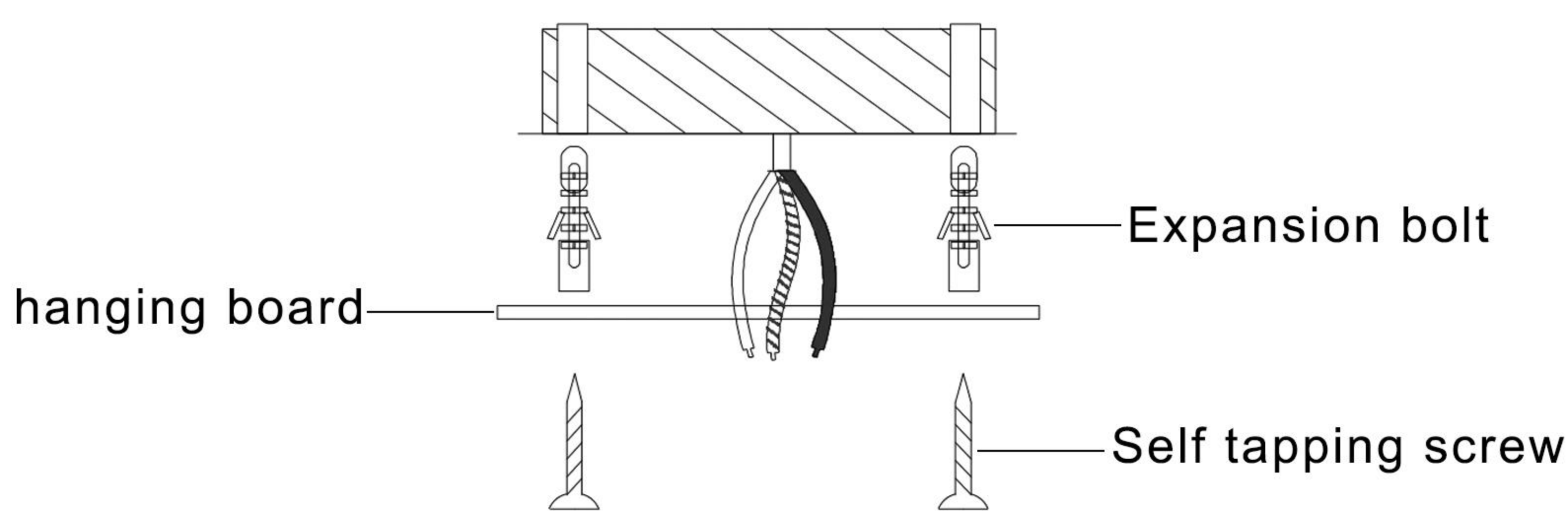

STEP 3

3. Make the electrical connection from ceiling to the fixture. Connect the ground wire to the mounting plate using the GREEN hex-head ground screw. Connect the ground wire with the ground wire from the ceiling. Then connect the live wire (fire wire) from the fixture with the live wire from the ceiling by wire connector. Connect the naught wire from the fixture with the naught wire from the ceiling by wire connector. As follow the picture.

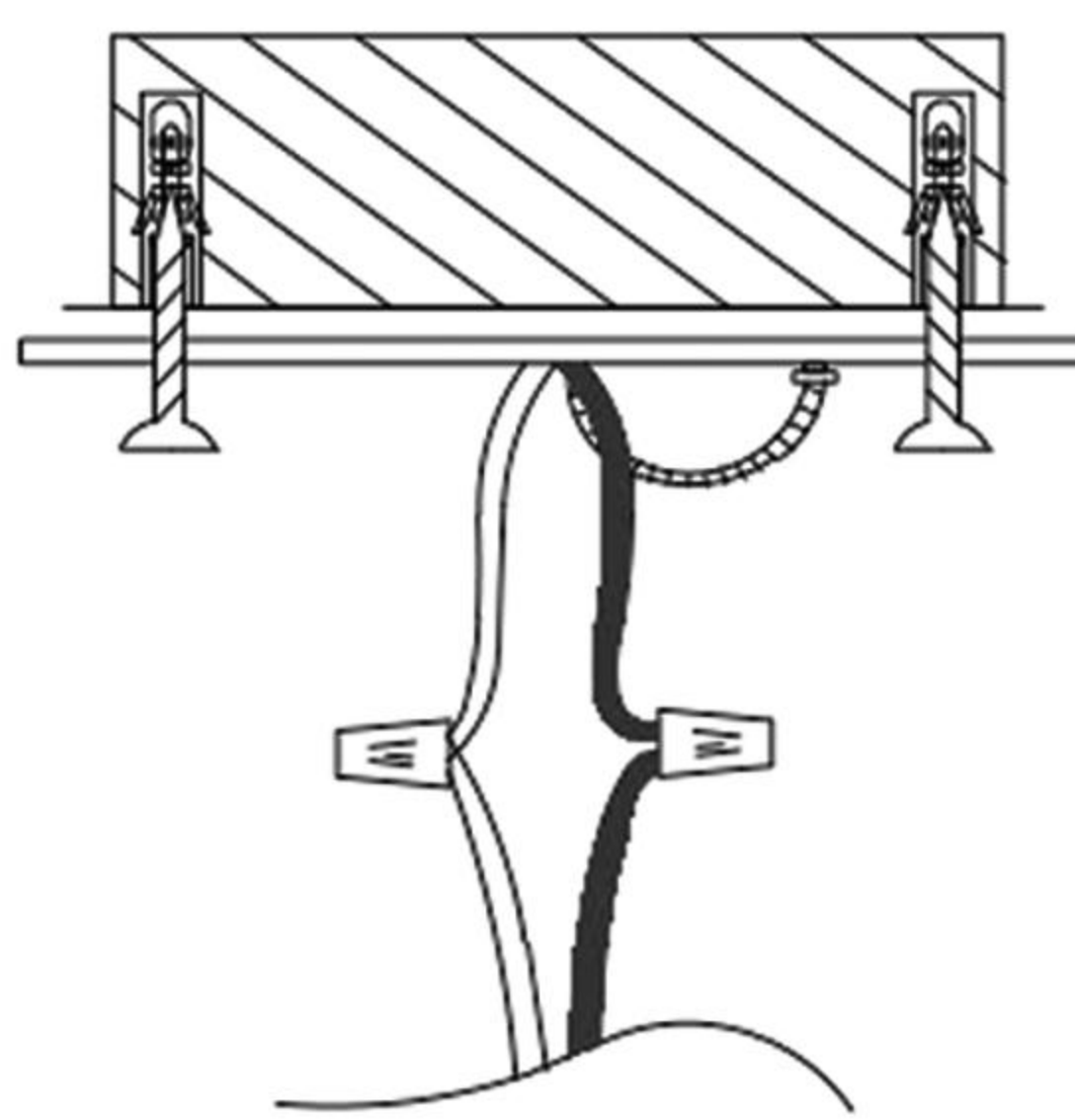

STEP 4

4. After aligning the hanging plate with the expanding bolt, place the gasket and tighten the screws.

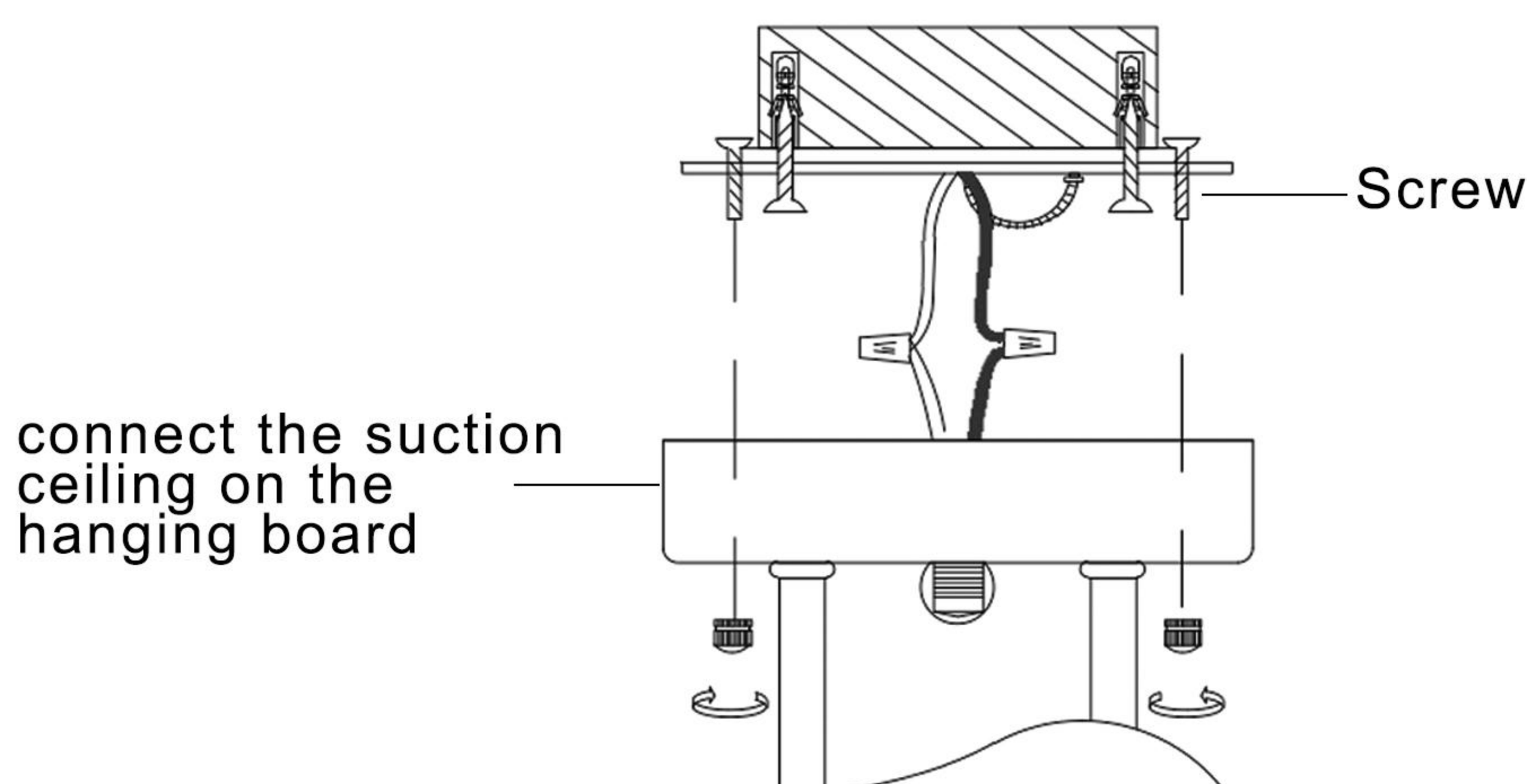

Your fixture is now assembled and ready to use.