

Installing Instructions

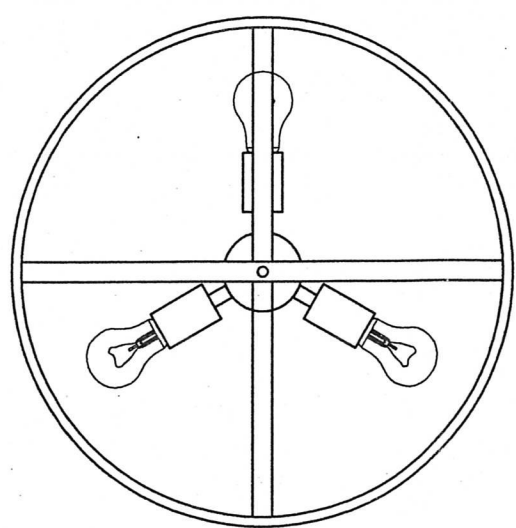
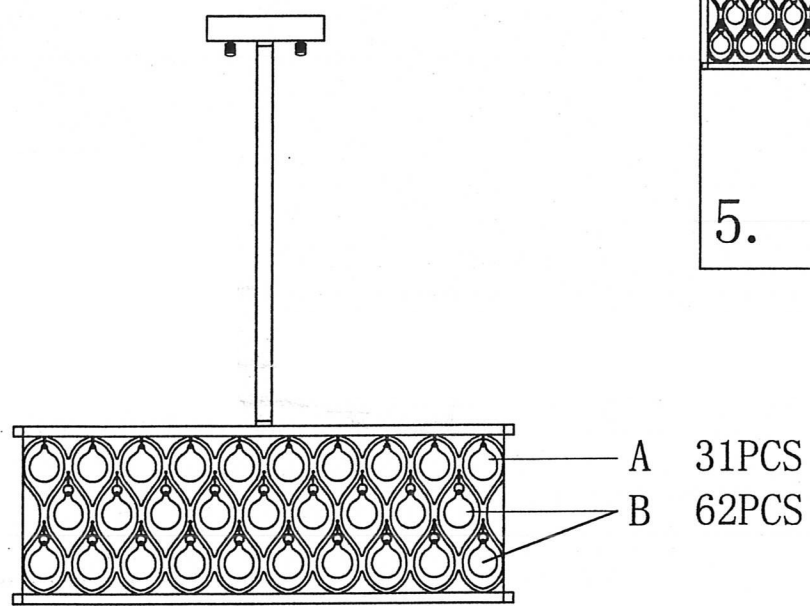
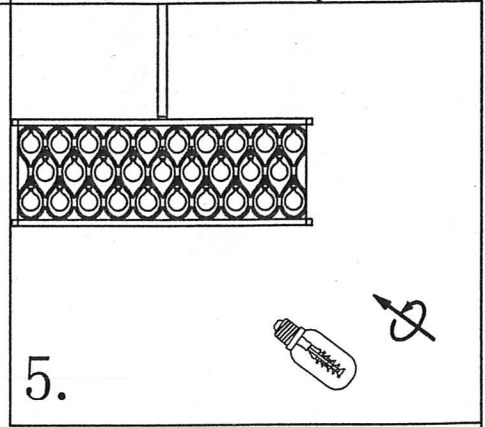
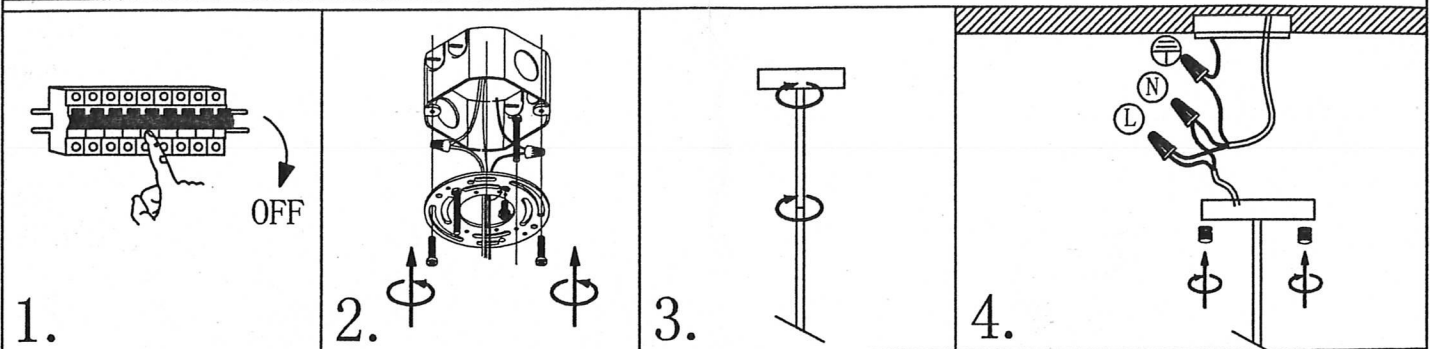

NOTE:
1: This lighting only can be use in room.
2: Do not turn switch on before Assembly.
3: If you want change bulb, please turn switch off, and after the bulb is cold.
Voltage: 110V
Bulb: E26