

# ASSEMBLY INSTRUCTIONS

- Description: Queen Headboard, Monterey Brown

Page 01 of 03

## Hardware List

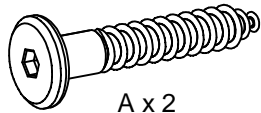

A x 2  
(M7 x 50)

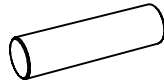

B x 4  
(Ø8 x 30)

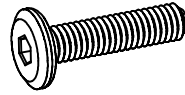

C x 4  
(M6 x 40)



D x 4  
(M6 x Ø19)

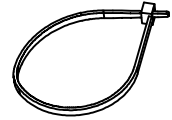

E x 2

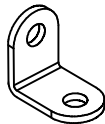

F x 2

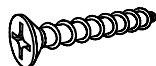

G x 2  
(M4 x 50)

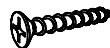

H x 2  
(M4 x 20)

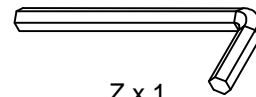

Z x 1  
(M4)

## Component List

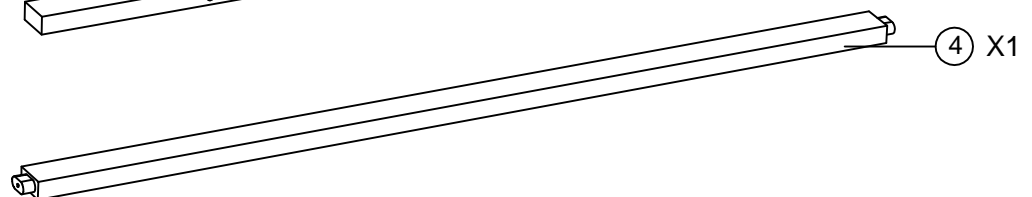
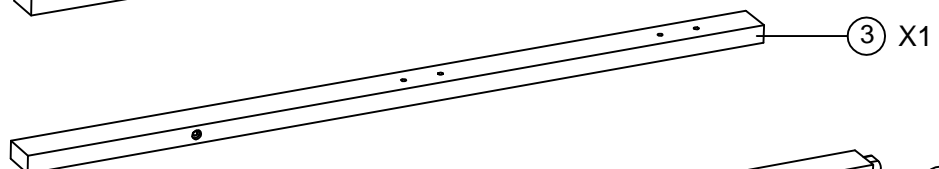
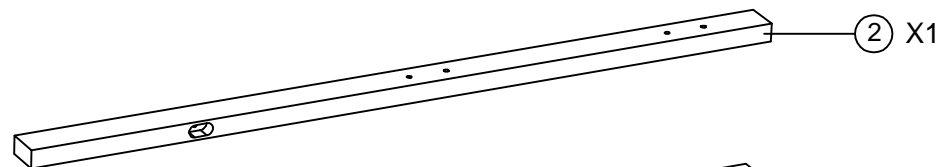
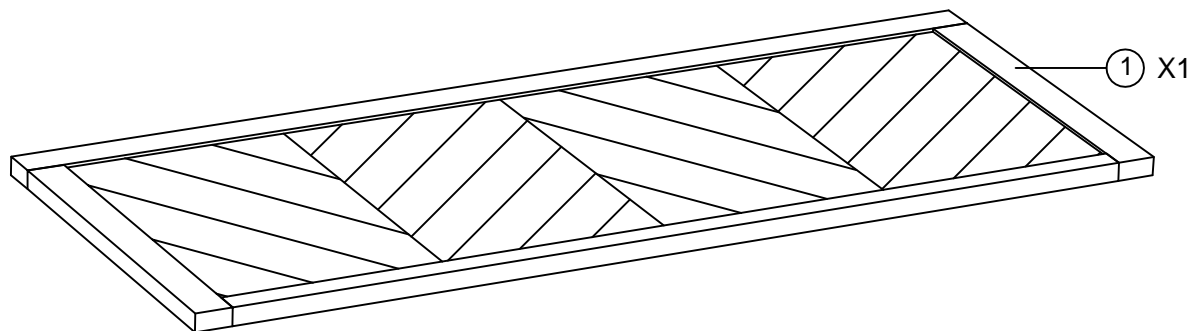

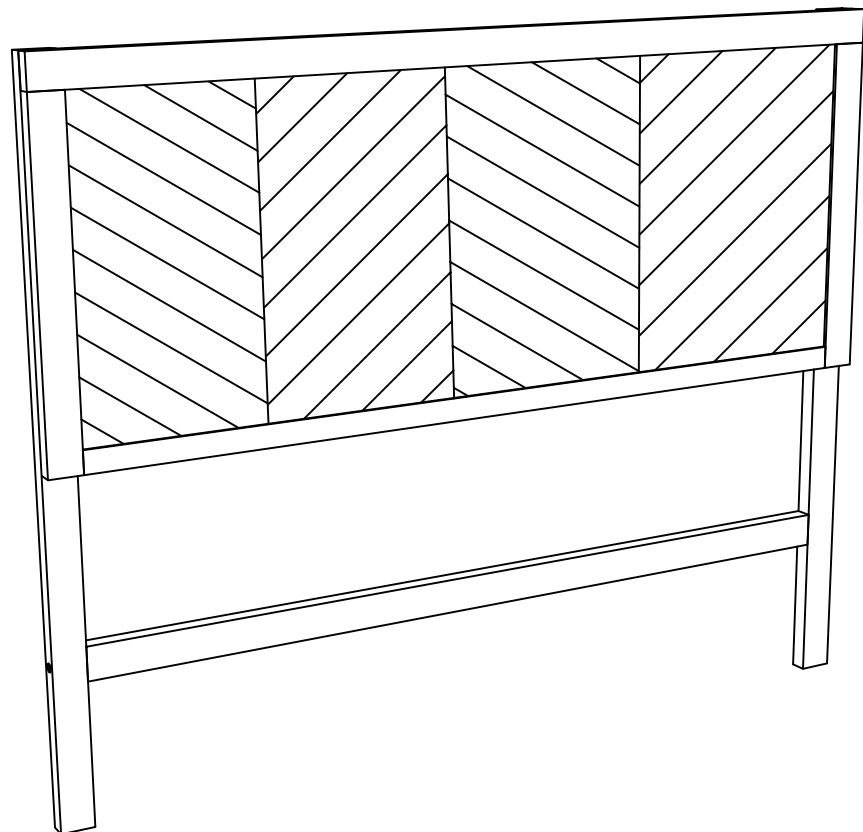
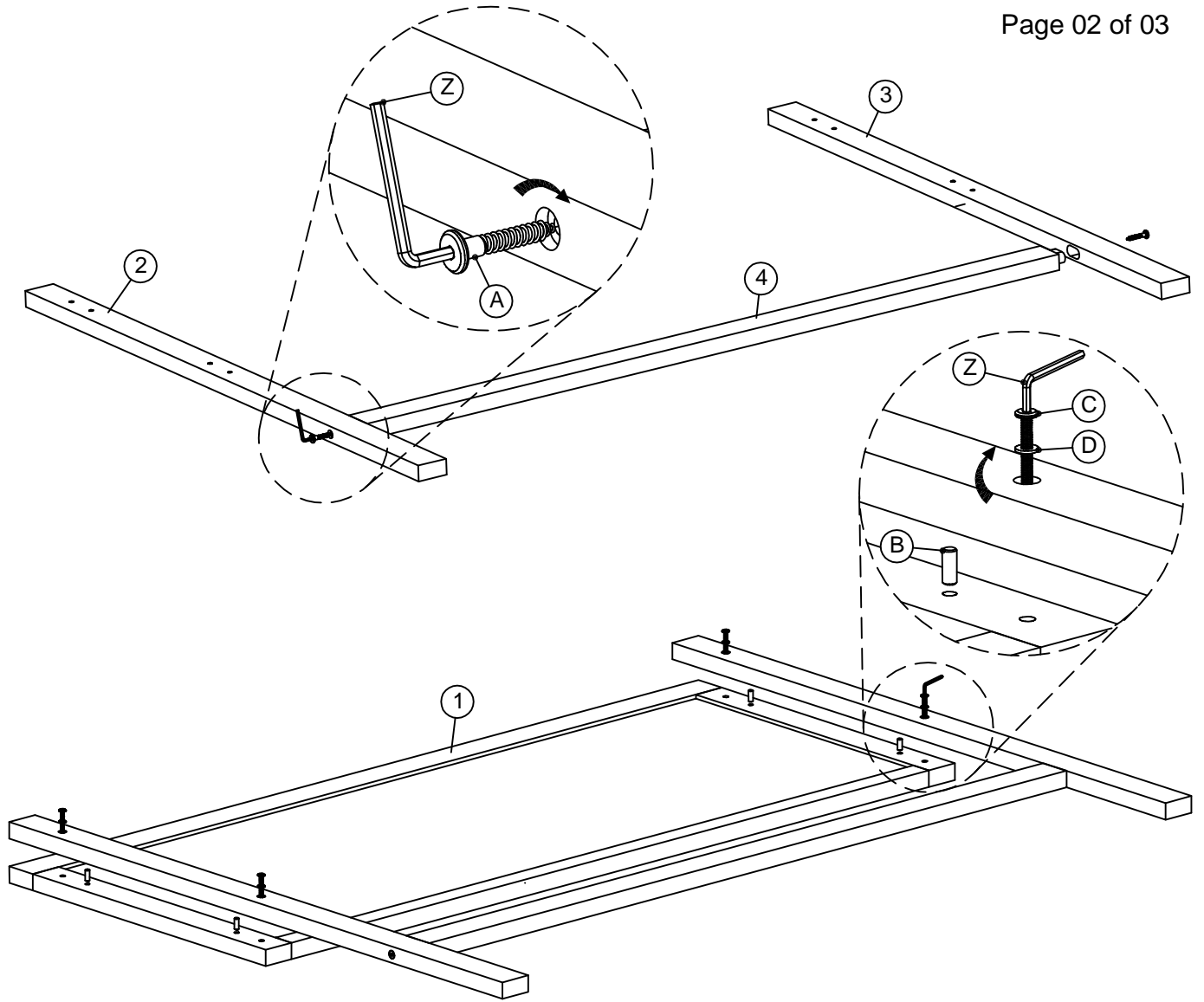

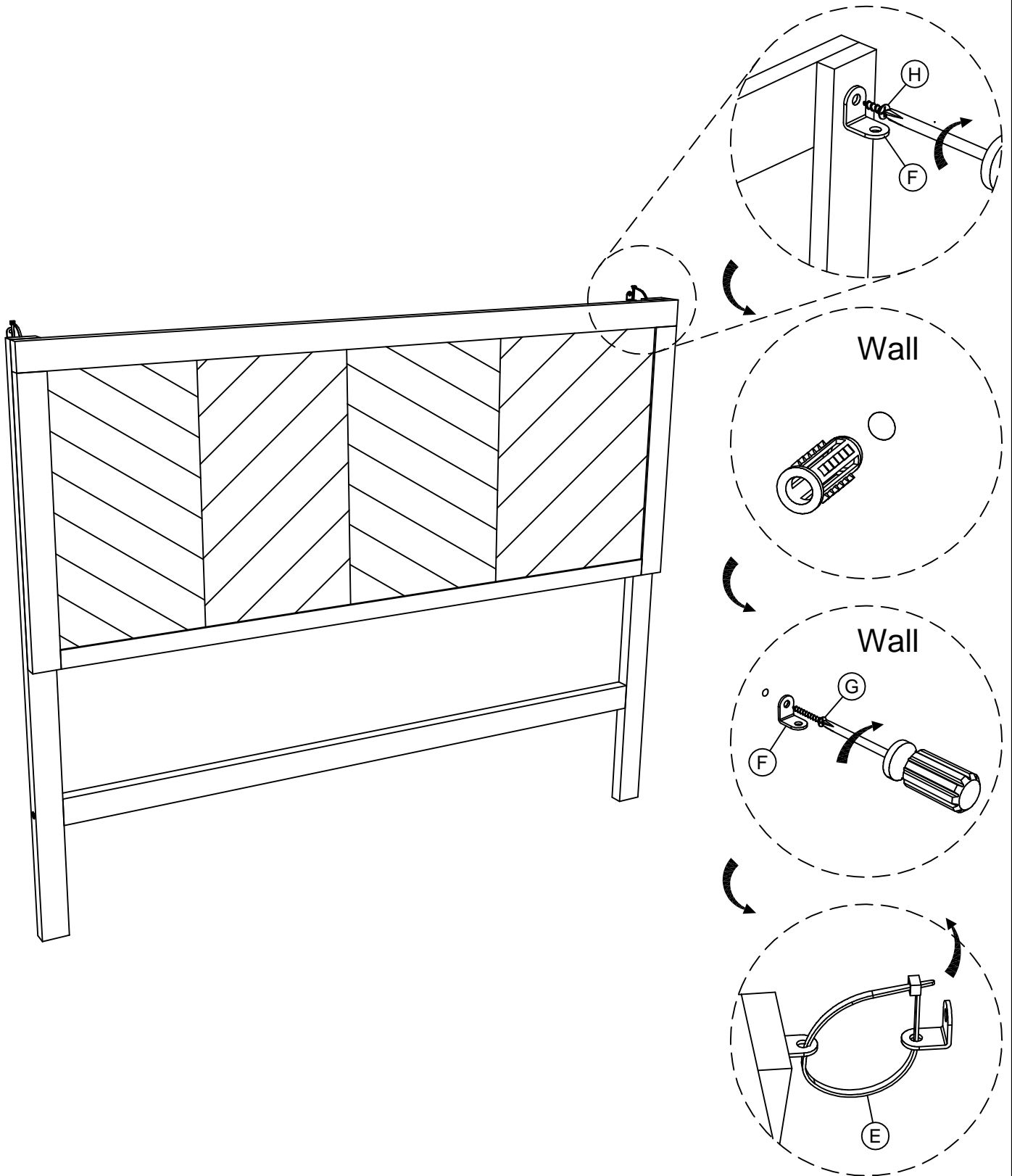

**"IMPORTANT"**

1. Screwdriver is not supplied. Please secure the unit to your wall using the appropriate tool for your wall type, there are readily available from your local DIY/ home improvement stores.
2. Before drilling into your wall check for wires or electric cables.