

Owner Manual



Weight Capacity

300 LBS



Installation:
15 minutes.

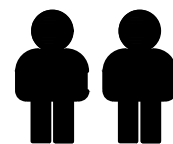

Two Person

Thank You For Choosing Our Furniture

If you have any questions or concerns,
don't hesitate to reach out to us.

NOTE:





This brochure contains
IMPORTANT safety info.
Please read and keep it
for future reference.

MAINTENANCE AND WARNINGS



Before You Start

Please follow the steps below:

-  Check the packaging for any damage, deformation, or water stains. If there is significant damage, please contact us promptly.
-  Unpack the box and compare the contents with the parts list and hardware list to ensure all components and accessories are present and complete.
-  Please read the installation instructions carefully to understand the installation steps and precautions to ensure proper installation.
-  Clean the installation area in advance and ensure the ground is level and there is enough space to avoid damaging the furniture or making installation difficult.
-  Lay a protective mat on the ground to prevent scratching the floor during installation.

After-Sales Service

- If you encounter any issues or need technical support during use, please contact our after-sales team. We offer long-term maintenance and warranty services.



Precautions

- ⚠ This product is for indoor use only. Do not expose it to outdoor elements or high-humidity environments.
- ⚠ Keep the product away from high heat or open flames to prevent fire hazards.
- ⚠ Do not allow children to climb on the product, as this may cause tipping and result in personal injury.



Safety Warnings

- ⚠ If you notice any loose or damaged parts, stop using the product immediately and contact customer service.
- ⚠ Do not attempt to disassemble or replace any components yourself, as this may affect the stability and safety of the product.

Daily Maintenance

- Regularly clean the surface with a soft cloth to prevent dust accumulation.
- Do not use cleaning agents containing acids, alkalis, or corrosive substances, as they may damage the surface. It is recommended to use neutral cleaning agents or specialized furniture cleaners.
- Avoid exposing furniture to humid environments for extended periods. Use a dehumidifier or desiccant during humid weather.
- Avoid direct contact of furniture with water. If water is accidentally spilled, wipe it dry immediately.
- Avoid placing excessively heavy objects on the furniture: ensure the weight is within a reasonable load-bearing range.
- Avoid using sharp or rough items on the furniture surface to prevent scratches. Handle items gently when moving them.

Explosive view

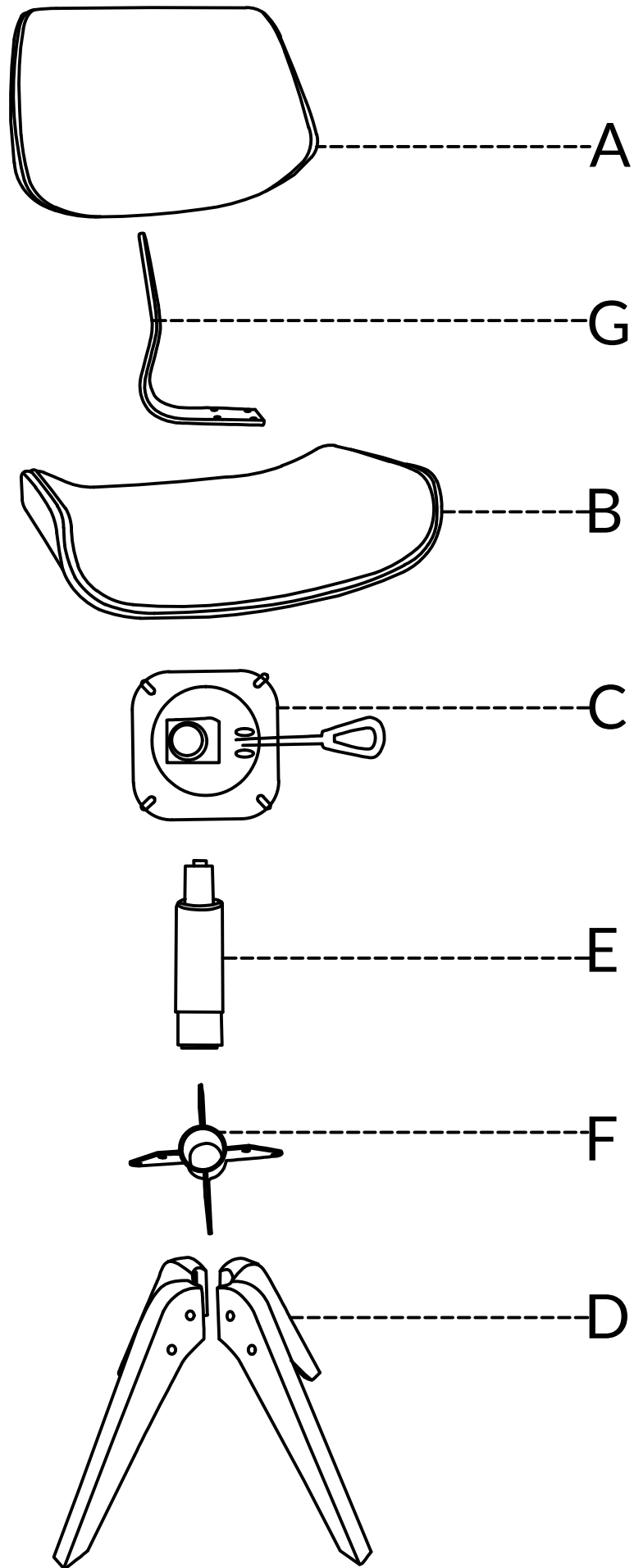

Parts list

A x1 Back

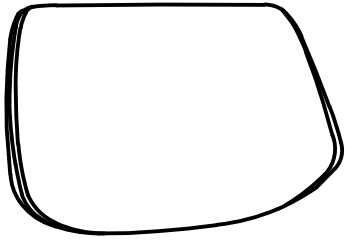

B x1 Seat cushion

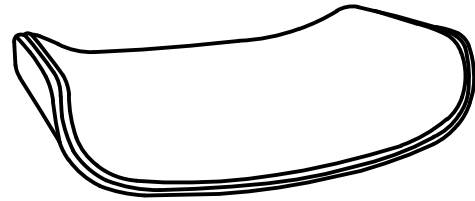

C x1 Regulator

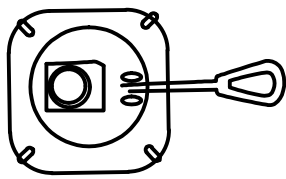

D x4 Legs



E x1 Gas lift

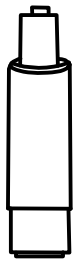

F x1 Central axis

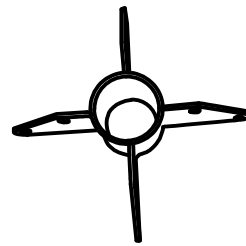

G x1 Connecting rod



Hardware List

①x1 Wrench



M6

②x4+1 Screw

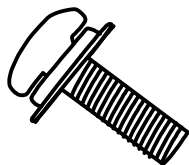

M6X20mm

③x4+1 Screw

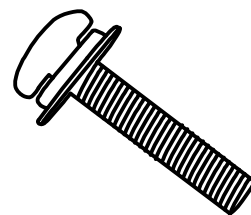

M6X30mm

④x8+1 Screw

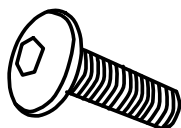

M6X20mm

⑤x3+1 Screw

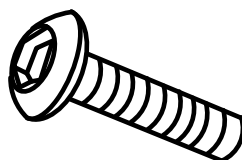

M6X30mm

⑥x8+1 Through nut



M6X20mm



⑦x1 Wrench

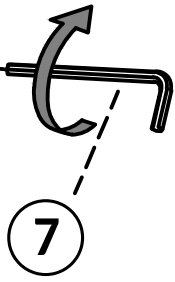
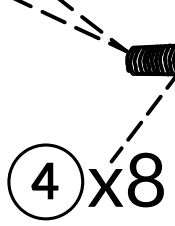
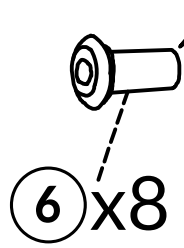
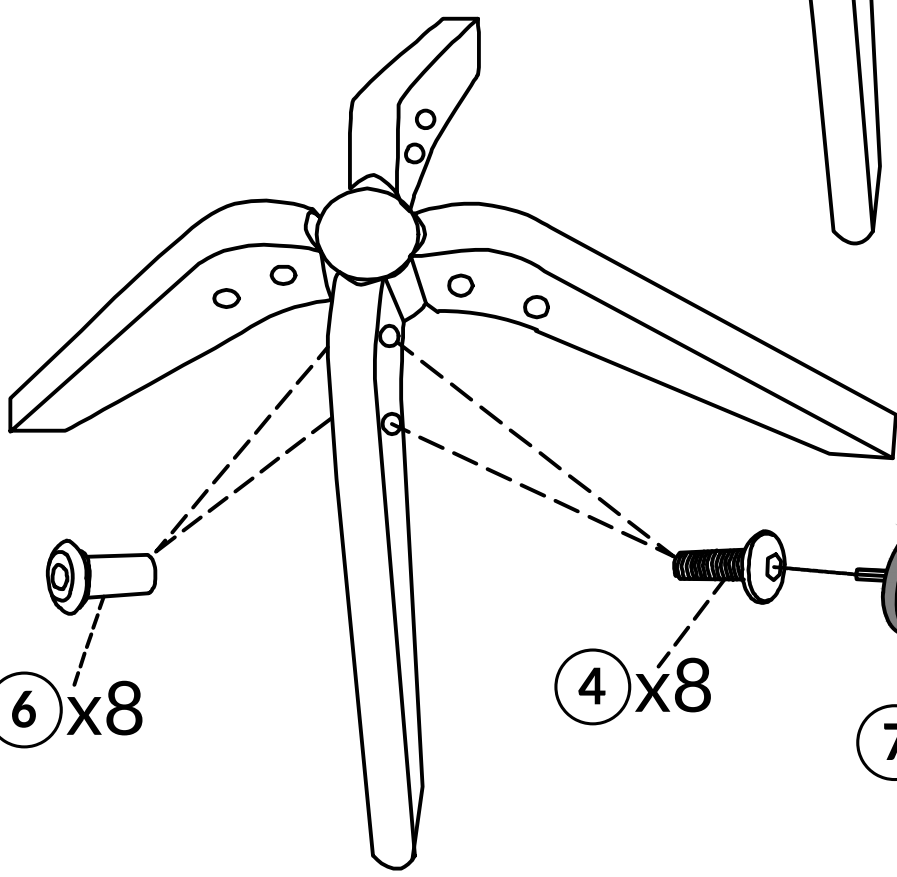
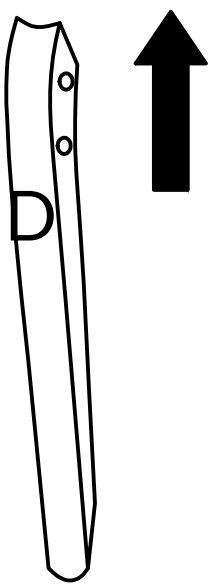
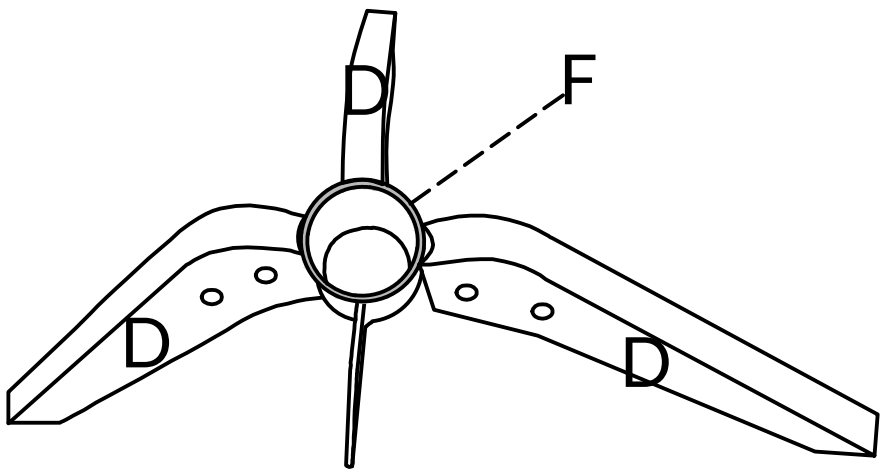

M5

Step 1



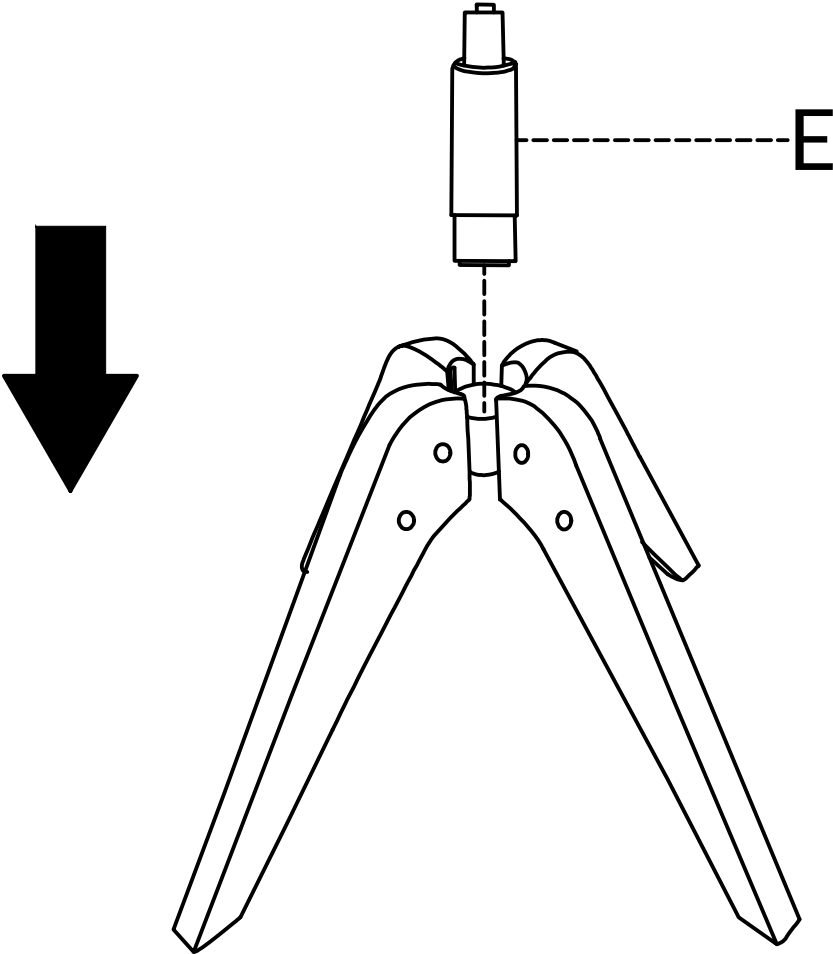

④x8	⑥x8	⑦x1
		
M6X20mm	M6X20mm	M5

Step 2



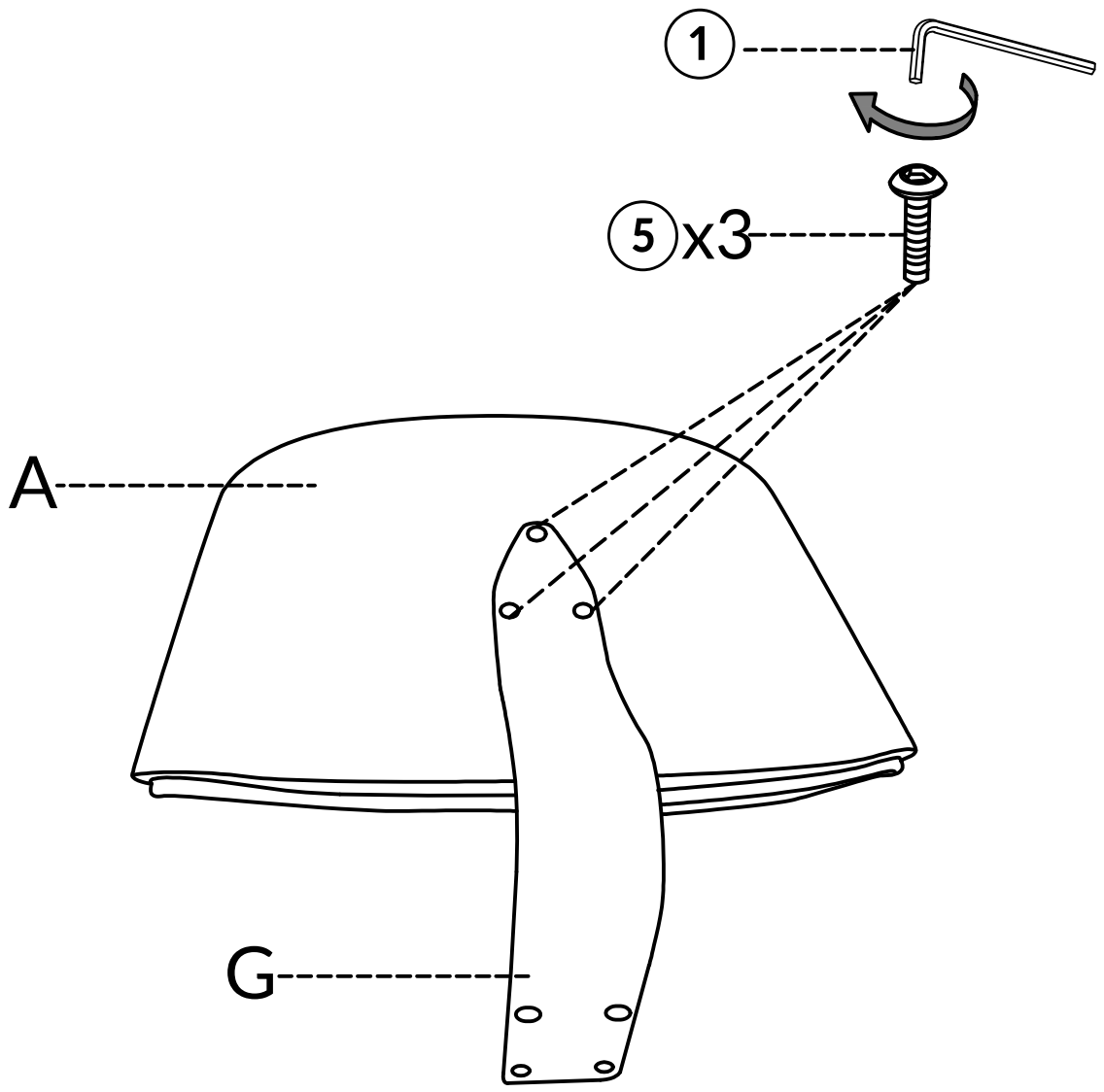

Step 3

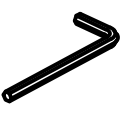

⑤x3	①x1
	
M6X30mm	

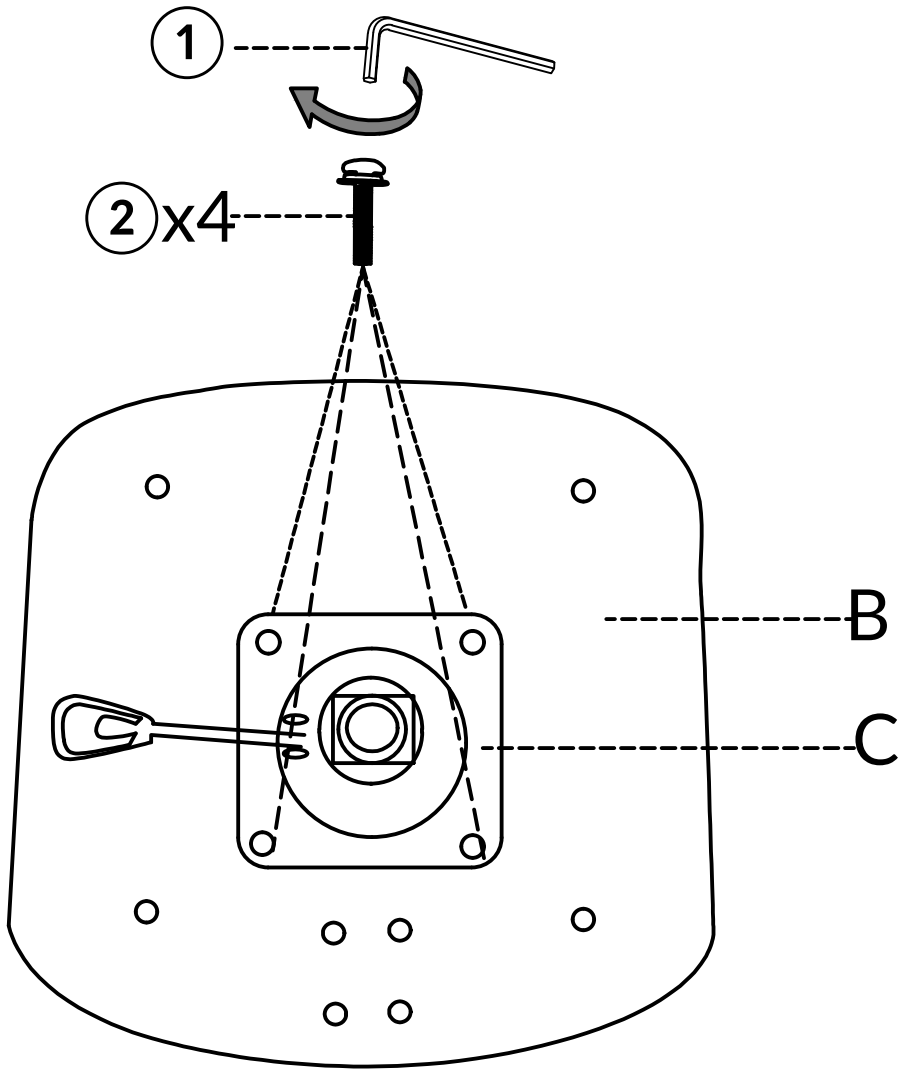
Step 4





②x4	①x1
	
M6X20mm	

Step 5

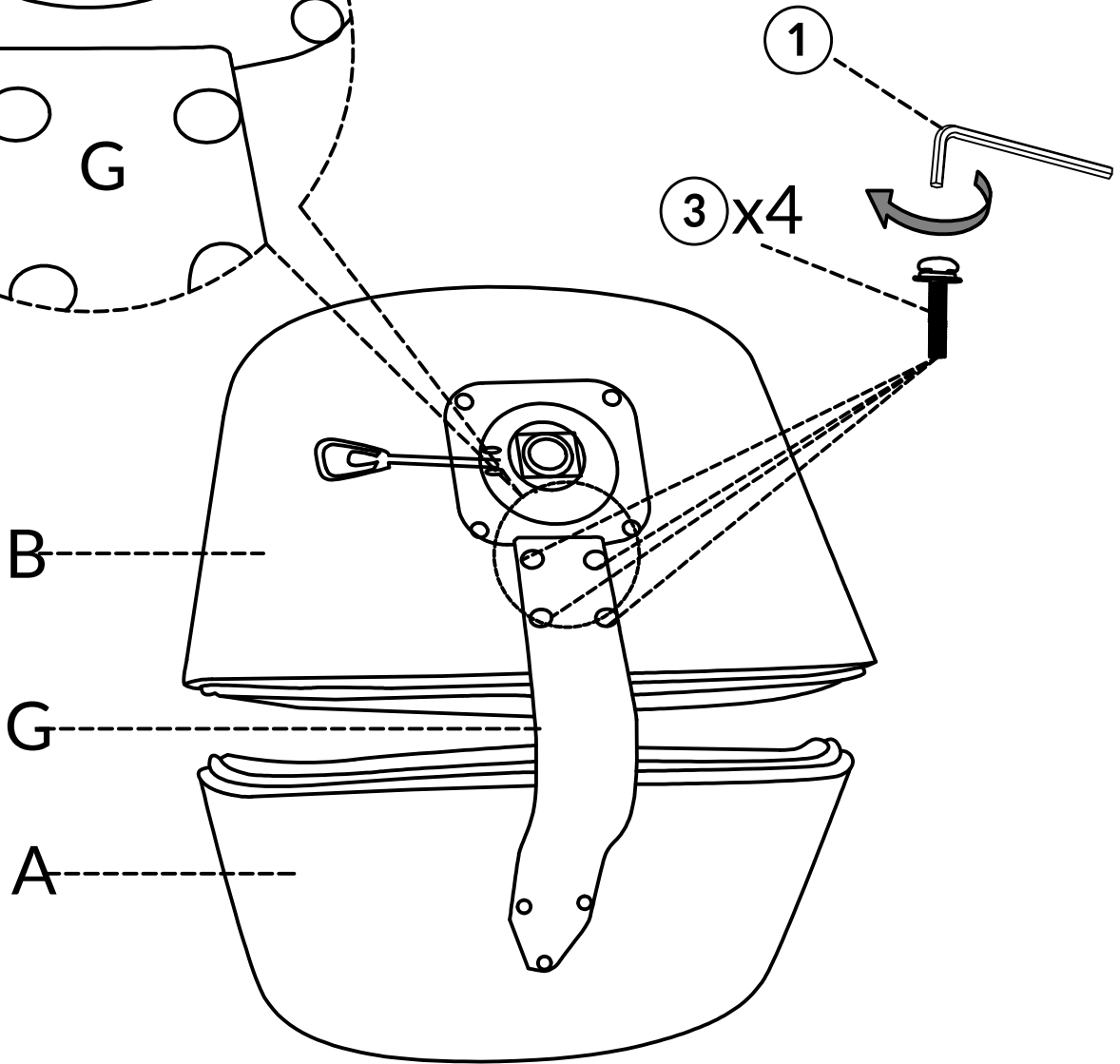
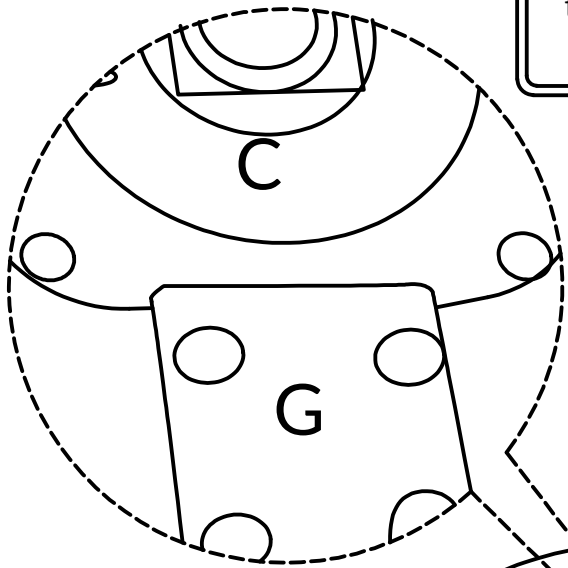
!
Press the steel plate onto the pallet



③x4	①x1
	
M6X30mm	

Step 6



If backrest A is crooked,
loosen the screws connecting
backrest A and G, level it, and
then tighten the screws again.

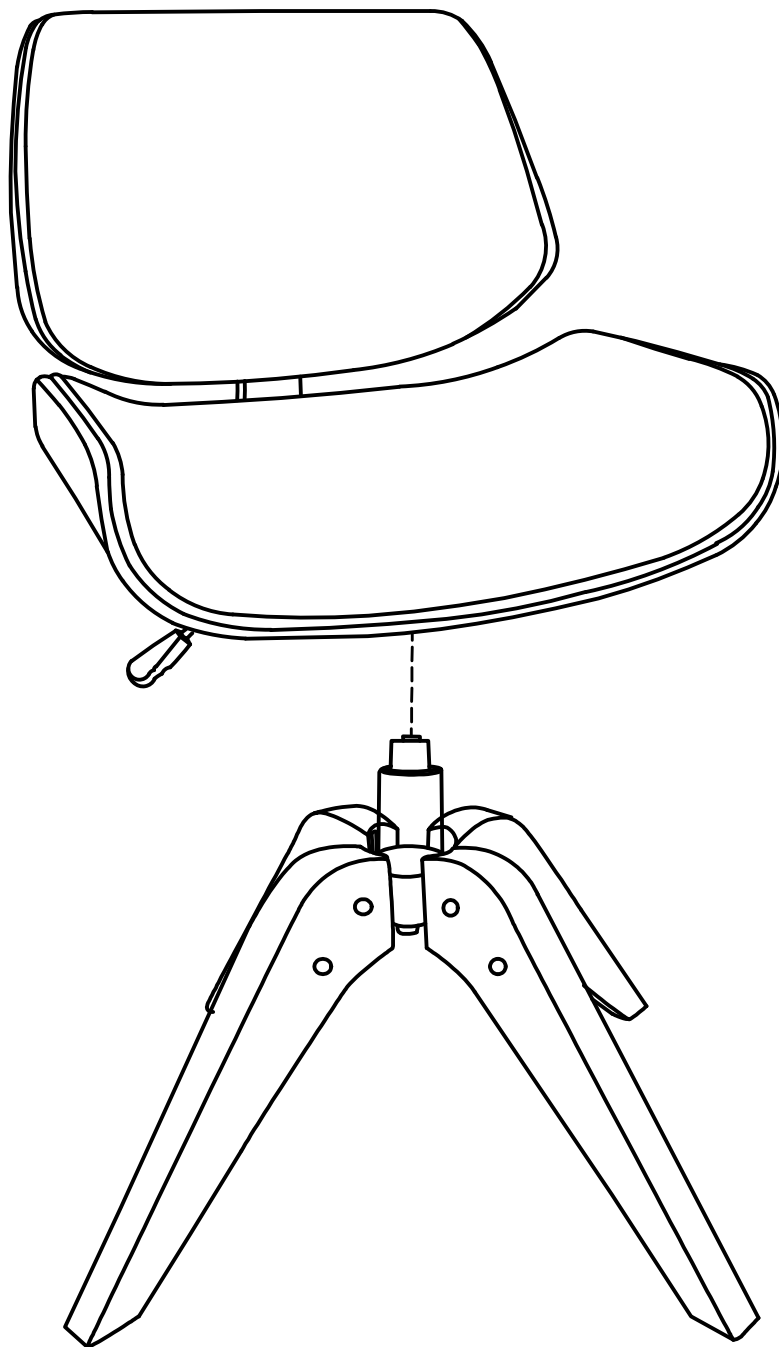

Step 7

Adjust the chair height by pulling lifting lever.

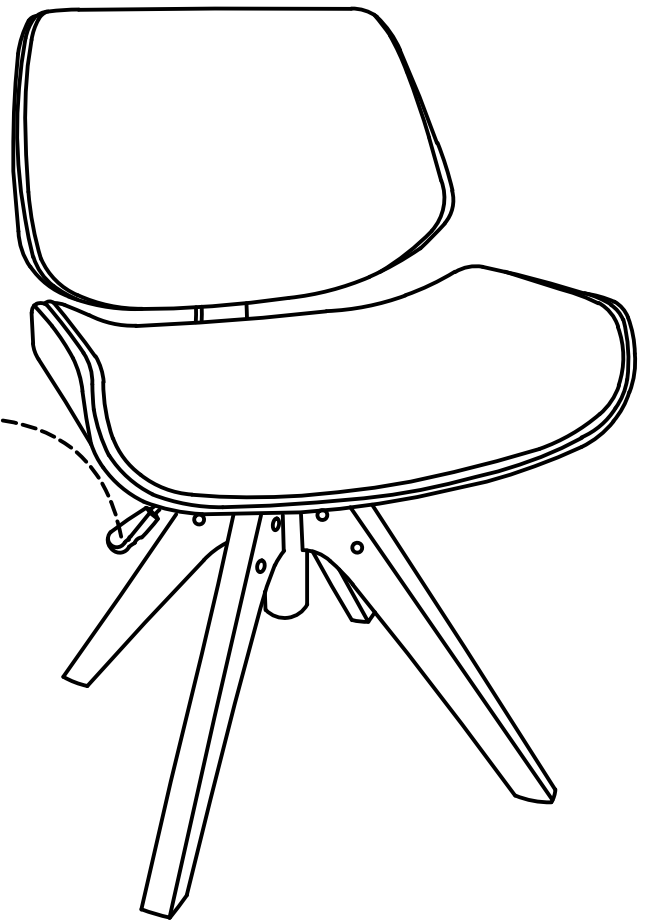
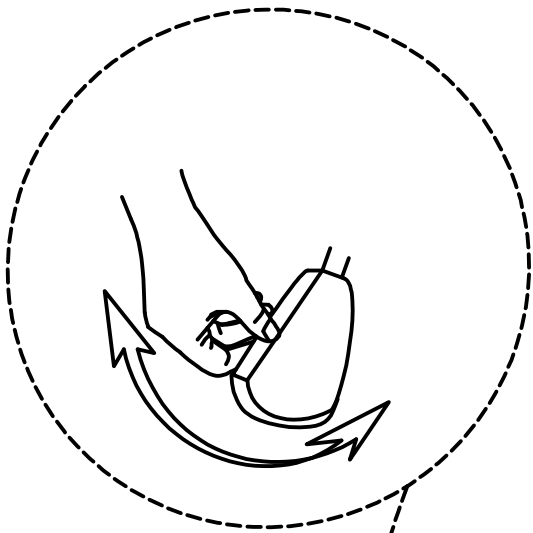

WARRANTY

- We strive to offer quality products, and we also try our best to satisfy every customer who orders from us with products or services as needed.
- Replacement parts can be purchased from our company if available.
- For returns, please check the return policy with the retailer or marketplace where you purchased the item.

We appreciate your purchase.
Brighten your life with our furniture!