











# Assembly Instructions

**Caution : You must read this before you proceed**

## Care & Maintenance

- ⊘  ● Not for commercial use. For residential use only.
- ⊘  ● Prolonged exposure to rain may cause rusting which can stain floors.
- ⊘  ● Do not put hot items directly on furniture surface.
- ⊘  ● Do not clean furniture with harsh cleansers or polish.
- ✓  ● To obtain the longest lifespan of your outdoor products, minimizing exposure to direct sunlight is recommended.
- ⊘  ● Children should not climb or jump on the furniture.
- ⊘  ● Do not write on furniture without a padded barrier to protect the surface.
- ✓  ● To obtain the longest lifespan of your outdoor products, avoid extended and lengthy exposure to rain, snow, and direct sunshine. Whenever possible cover the product and /or place under patio or awnings.
- ⊘  ● Stains may be removed with mild soap solution and damp cloth.
- ✓  ● Keep away from sources of ignition.
- ✓  ● Dust and pick-up spills using a clean, non-colored, lint-free cloth.

**Please look in swivel chair for hardware packs and legs.  
Sets often ship in multiple boxes and may arrive a day or two apart.**

# Swivel Chair

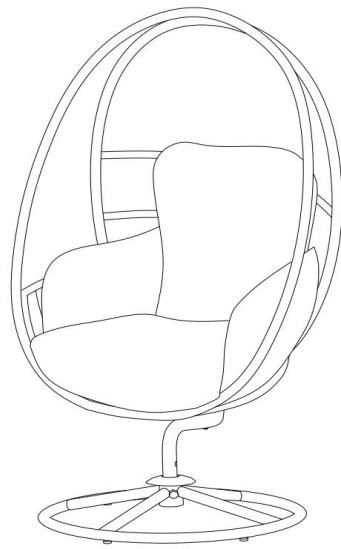





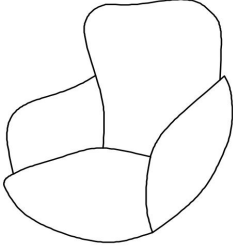

## Parts List

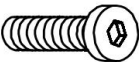
Label	Picture	Description	QTY
A	A line drawing of a single, curved metal pole. It has a small rectangular tab at the top end and a slightly wider, flared base at the bottom end.	Pole	1
B	A line drawing of a swivel base. It consists of a central vertical post that fits into a circular plate. The plate has four radial spokes extending to the outer edge, which is slightly raised to form a rim. Small feet are visible at the bottom of the rim.	Base	1
C	A line drawing of the basket frame, showing the oval shape and the internal grid structure of the basket.	Basket Frame	1
D	A line drawing of a curved, crescent-shaped section of the basket frame, showing the grid pattern.	Basket Front Part	1

E		Cushion	1
---	-----------------------------------------------------------------------------------	---------	---

## Hardware

Label	Picture	Description	QTY
①		Bolt (M6*15mm)	3
②		Bolt (M6*35mm)	7
③		Bolt (M6*55mm)	2
④		Washer (M6)	10
⑤		Bolt (M8*15mm)	2
⑥		Allen Wrench S4	1
⑦		Allen Wrench S6	1

## Assembly Preparation

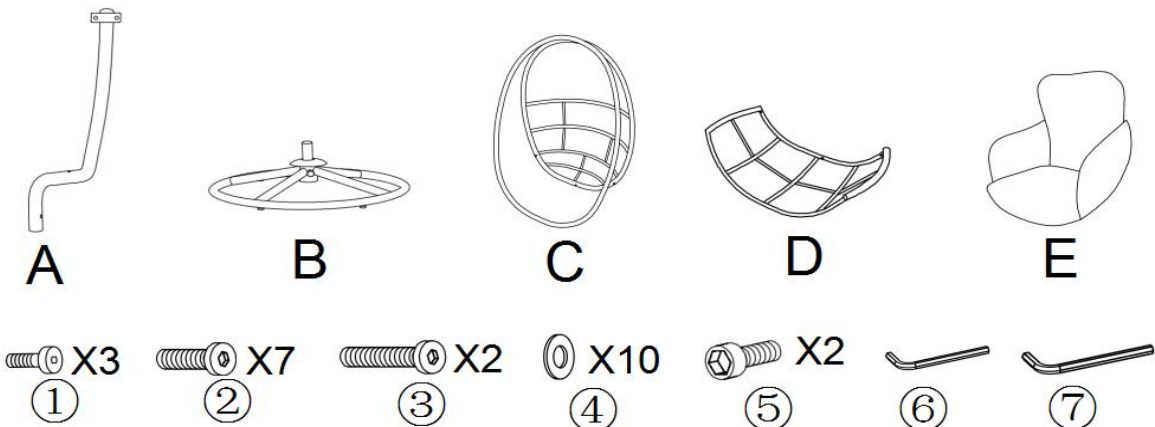
Before Beginning Assembly:	 <p>The diagram shows the following components and hardware requirements:</p> <ul style="list-style-type: none"> <li><b>A:</b> A long, curved metal arm with a small hook at the top.</li> <li><b>B:</b> A circular base plate with a central hub and four radial spokes.</li> <li><b>C:</b> A circular mesh backrest.</li> <li><b>D:</b> A curved mesh seat cushion.</li> <li><b>E:</b> A cushioned seat.</li> </ul> <p>Hardware quantities for each component:</p> <ul style="list-style-type: none"> <li><b>A:</b> 3 bolts (①)</li> <li><b>B:</b> 7 bolts (②)</li> <li><b>C:</b> 2 bolts (③)</li> <li><b>D:</b> 10 washers (④)</li> <li><b>E:</b> 2 bolts (⑤)</li> <li><b>Assembly:</b> 1 Allen Wrench S4 (⑥) and 1 Allen Wrench S6 (⑦).</li> </ul>						
----------------------------	--------------------------------------------------------------------------------------------------------------------------------------------------------------------------------------------------------------------------------------------------------------------------------------------------------------------------------------------------------------------------------------------------------------------------------------------------------------------------------------------------------------------------------------------------------------------------------------------------------------------------------------------------------------------------------------------------------------------------------------------------------------------------------------------------------------------------------------------	--	--	--	--	--	--



- Read instructions, cover to cover-



- Have 2 adults on hand for assembly-



- Do not assemble on flooring or carpet-



- Assemble on a clean non-marring surface (packing foam)-



- Save all packaging until finished-

## Assembly Steps

### Overview

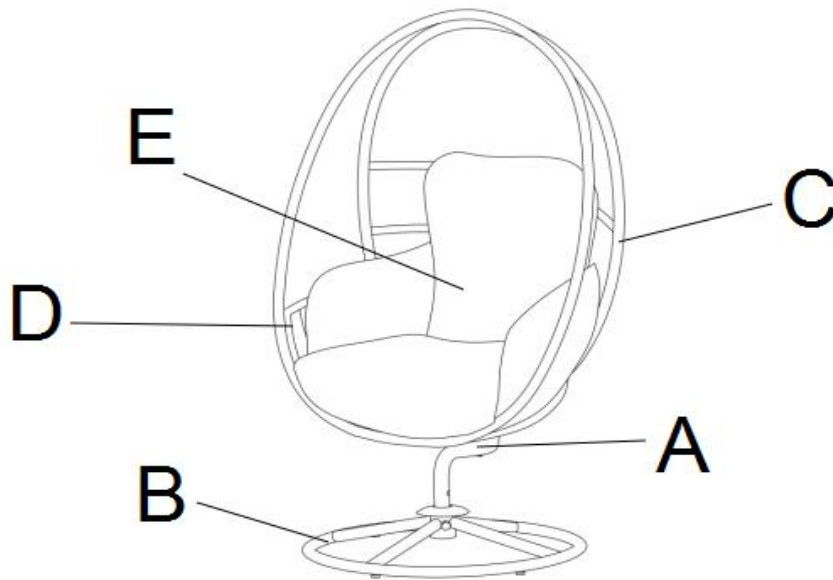

This swivel chair has multiple parts and may require up to 10 minutes to assemble. To give you an overview of the various parts, the above picture is to help you put the various parts into perspective. Please read through the instructions below to familiarise yourself with the parts and steps before assembly.

### Step 1

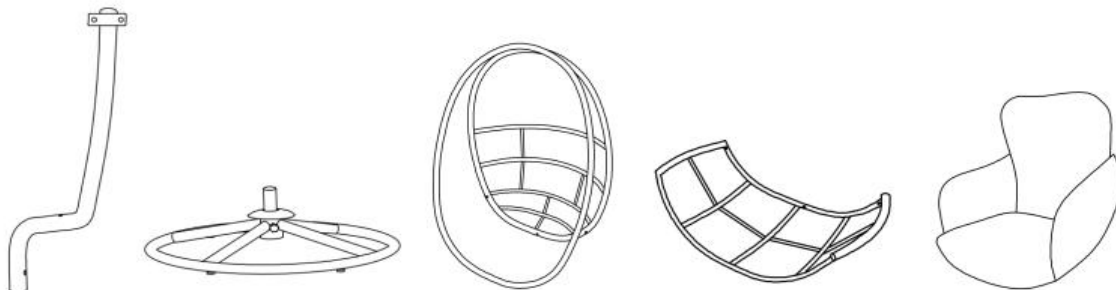

Unpack and place all parts on a clean, soft surface.

## Step 2

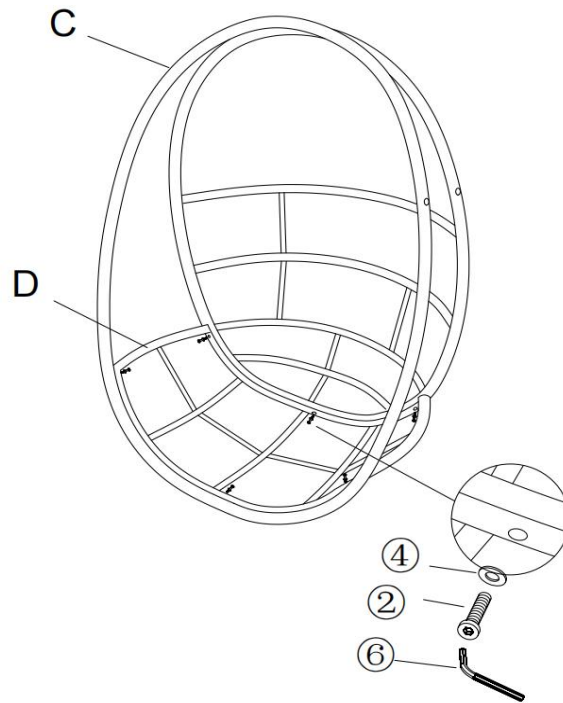

Place the Basket Frame(C) and Basket Front Part(D) on a clean, non-marring surface. Attach Basket Frame(C) and Basket Front Part(D) using Washer(④), and Bolts(②) with Allen Wrench(⑥). Fully tighten the Bolts.

## Step 3

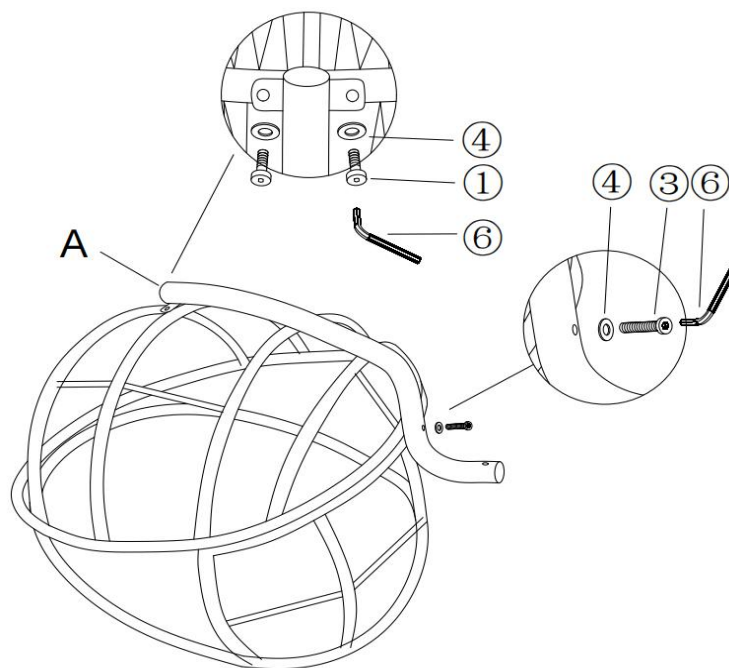

Attach Pole (A) and Basket Frame(C) using Washer(④), and Bolts(①) with Allen Wrench(⑥) and using Washer(④), and Bolts(③) with Allen Wrench(⑥). Fully tighten the Bolts.

## Step 4

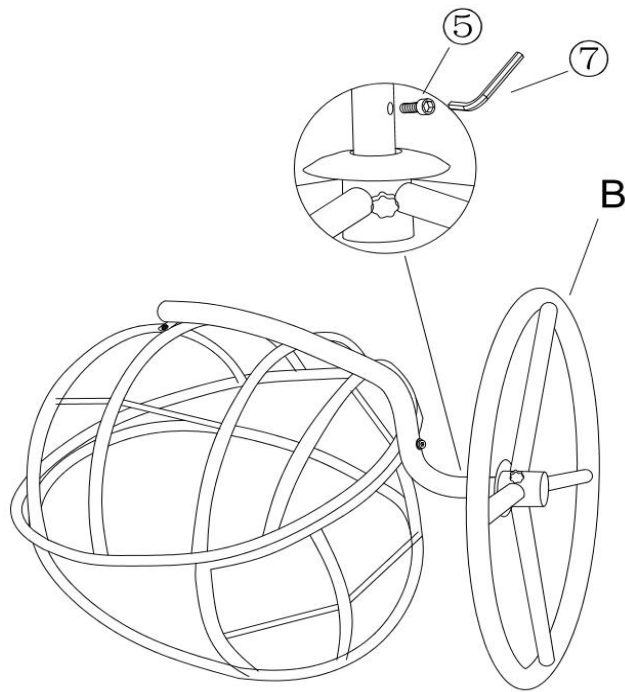

Attach Pole (A) and Base(B) using Bolts(⑤) with Allen Wrench(⑦).  
Fully tighten the Bolts.

## Step 5

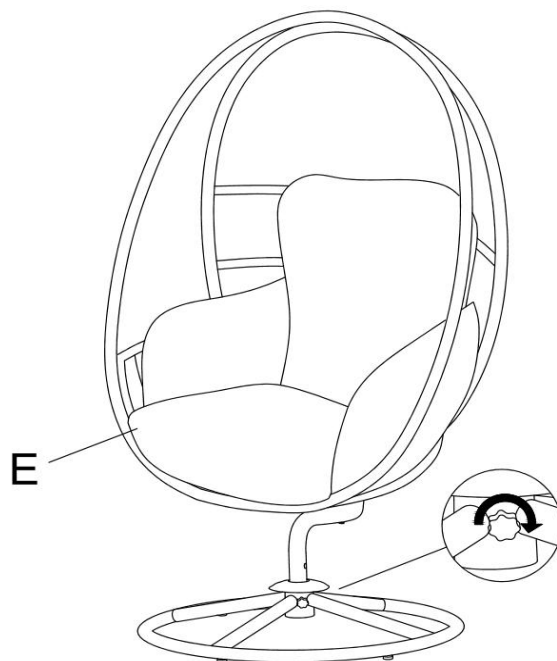

Put Cushion(E) and fix the cushion to the chair using belt of the cushion.  
The screw of the base can be controlled the speed of the swiveling.