











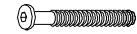

ASSEMBLY INSTRUCTION

COUNTER HEIGHT CHAIR

PART LIST				HARDWARE LIST			
1	Chair Back		1pc	A		Bolt Ø1/4" x 3"L	4pcs
2	Seat Frame With Cushion		1pc	B		Bolt Ø1/4" x 2-3/8"L	4pcs
3	Front Leg LSF		1pc	C		Bolt Ø1/4" x 1-1/2"L	3pcs
4	Front Leg RSF		1pc	D		Lock Washer (Ø1/4")	11pcs
5	Side Stretcher LSF		1pc	E		Flat Washer (Ø1/4")	11pcs
6	Side Stretcher RSF		1pc	F		Allen Key (4mm)	1pc
7	Front Stretcher		1pc	G		Screw (#8 x 1-1/2"L)	6pcs

Step 1

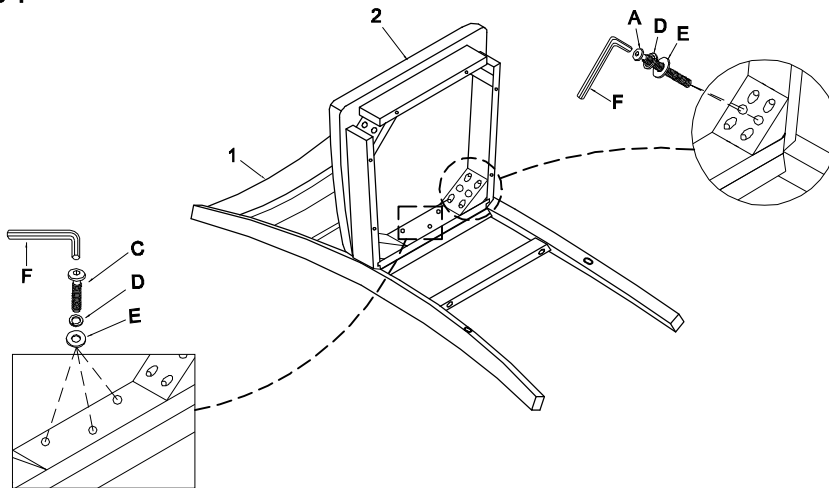

Completed

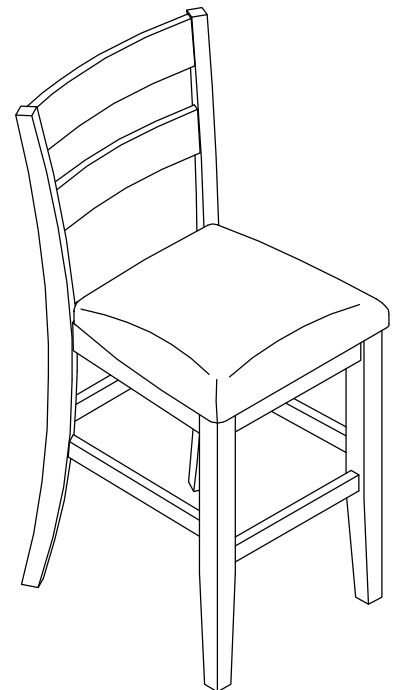

Step 2

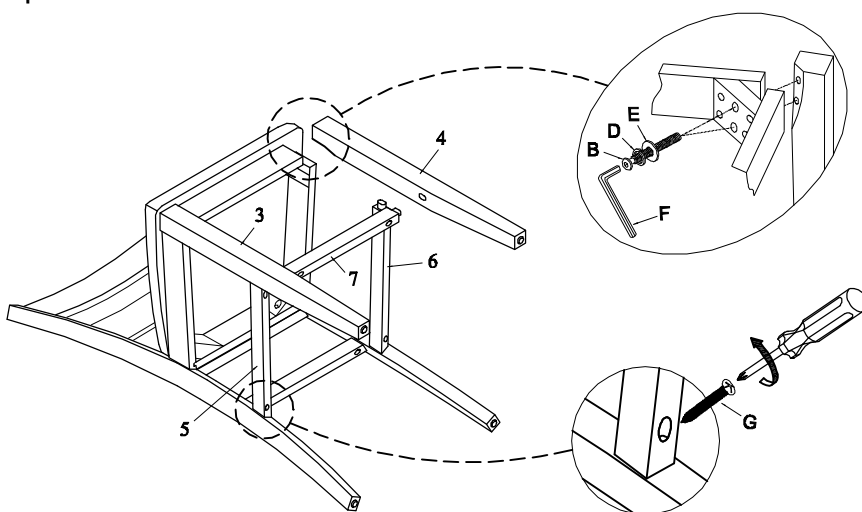

For items use on wooden floor, hard surfaces or carpets, it is recommended to Install protective pads under all legs and supports to avoid/prevent from damages/scratches and discoloration.