

Assembly Instructions

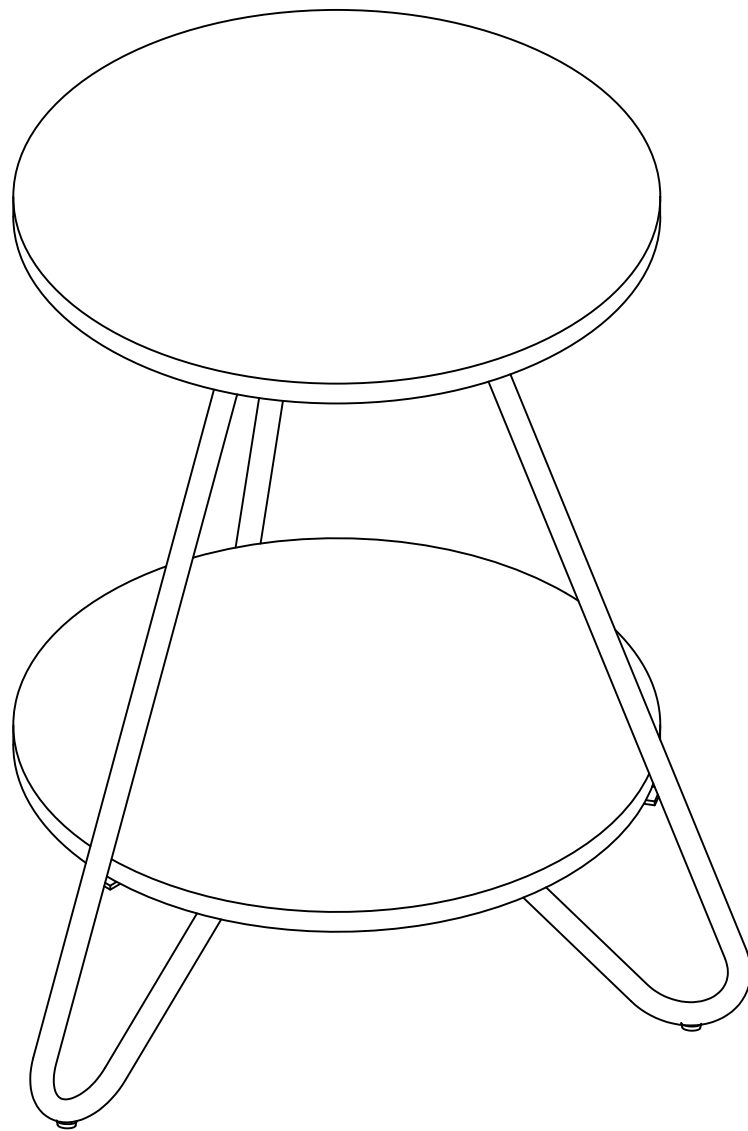

Multifunctional Computer Desk

Assembly Instructions:

1. Carefully read these instructions and keep them for future reference.
 2. Refer to the parts list for guidance and ensure that you have all the pieces before starting the assembly process, if anything is missing, damaged, incorrect, contact us **FIRSTLY BEFORE** assembling.
 3. When assembling, place all parts on a soft, clean, and flat surface, such as a carpet, to prevent any scratches.
 4. To avoid misalignment of the holes, Please don't full tighten the screws until you ensure all parts in place.
-

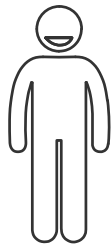

X2

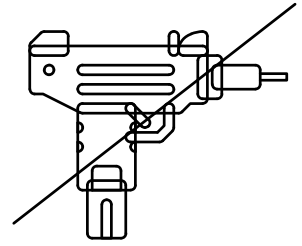
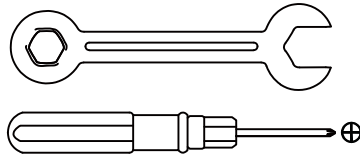

When using the electric screwdriver ,
Reduce the power and torque to avoid damaging the furniture

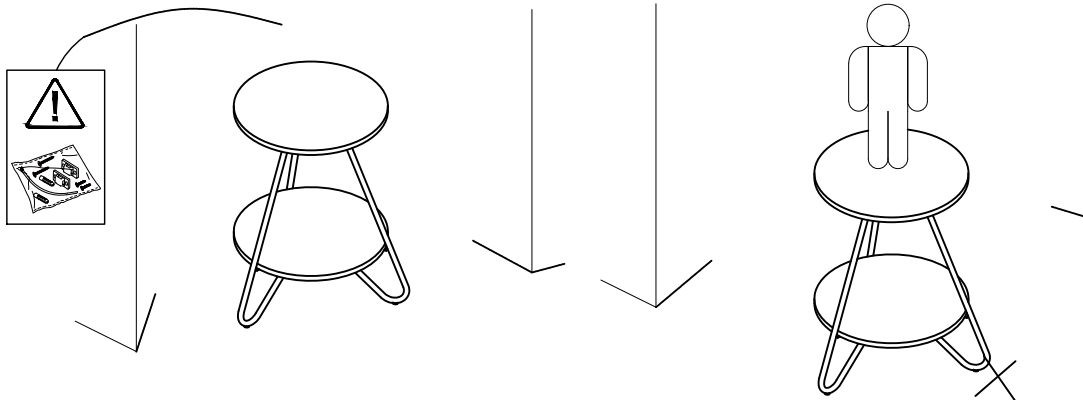
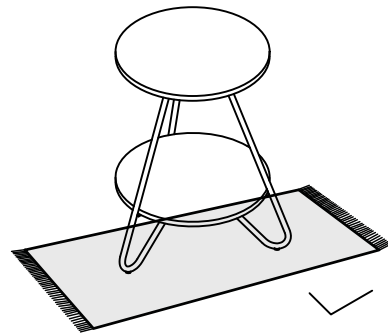
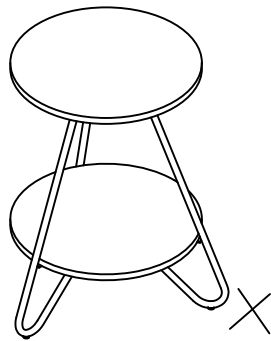
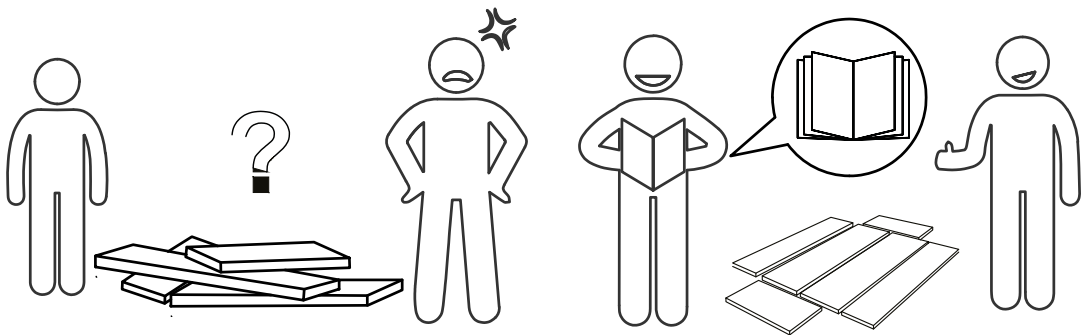

the risk of tip-over.

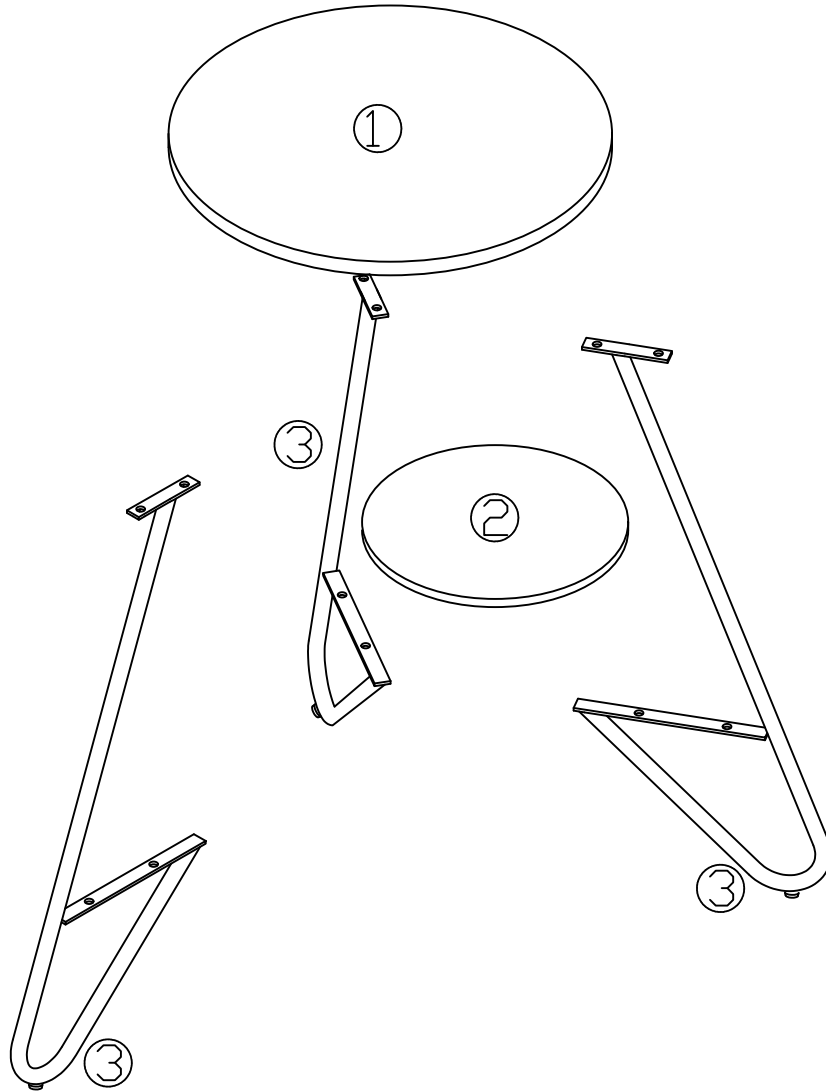

! Caution

Make sure all parts are included. Most board parts are labeled or stamped on the raw edge.

Contact us for free replacement if having damaged or missing parts.

Parts & Hardware List

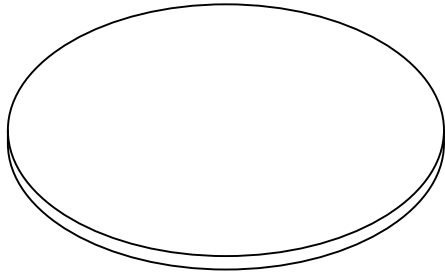

① 1PC

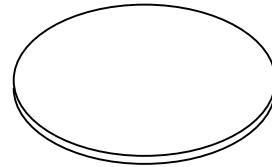

② 1PC

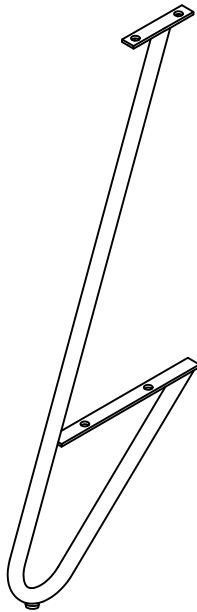

③ 3PCS

Hardware List

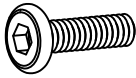
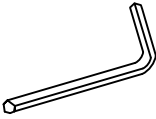
<p>A</p> <p>M6 ×12mm</p>  <p>12PCS</p>	<p>B</p>  <p>1PC</p>
---	---

①

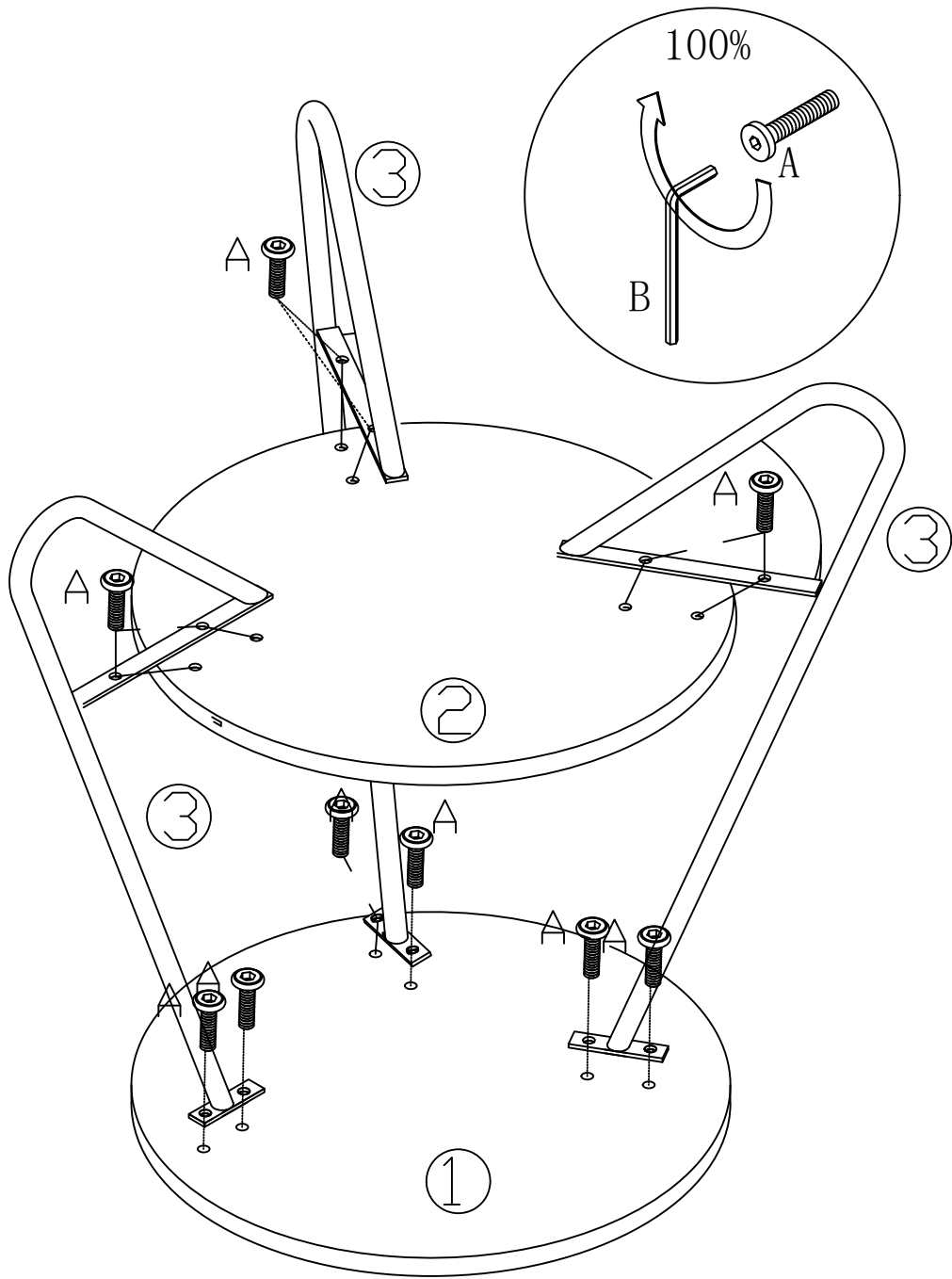

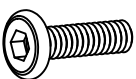
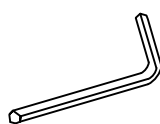
<p>A</p> <p>M6 × 12mm</p>  <p>12PCS</p>	<p>B</p>  <p>1PC</p>
--	---

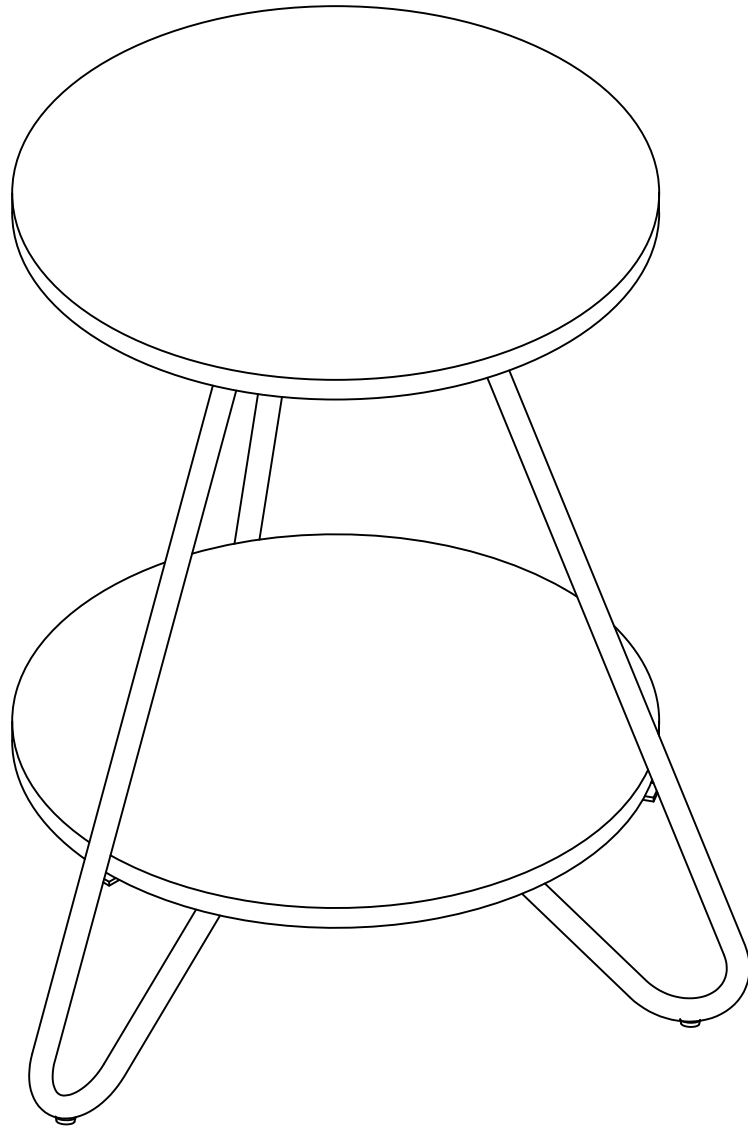

**We genuinely appreciate your purchase of our product.
Any problem (installation or damage caused by shipping),**



No heartburn,
when we handle
the return

Our way



Replacement/Refund



You

Their way



Re-package item



Schedule pick-up



Track package



Replacement



You
