

# Assembly Instruction

## Accent Chair









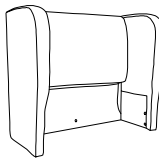

**Legs and hardware are stored in the chair seat, please take out for assembly.**

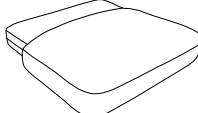
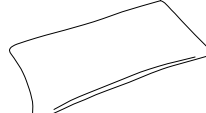
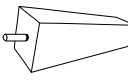
**Note: Do not use power tools for assembly. Power tools increase the risk of over tightening which lead to splitting or cracking the wood.**

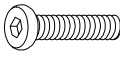
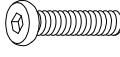
**Do not tighten bolts until completely assembled.**

### Component list

No	Drawing	Qty	Description
A		1	Chair back
B		1	Chair Seat
C		1	Seat Cushion
D		1	Lumbar Pillow (22"*11")
E		4	Wooden Legs 7.08"*2.36"*1.46"
F		4	Gasket Ø1.85"
G		4	Bolts (Colored) 5/16"*55mm
H		1	Bolts(black) 5/16"*70mm
I		5	Flat Washers Ø22*Ø8*2mm
J		5	Lock Washers 5/16"*13*1.5mm
K		1	Allen Wrench M5*70*70mm

# Step #1

LEGS AND HARDWARE ARE STORED IN THE CHAIR SEAT

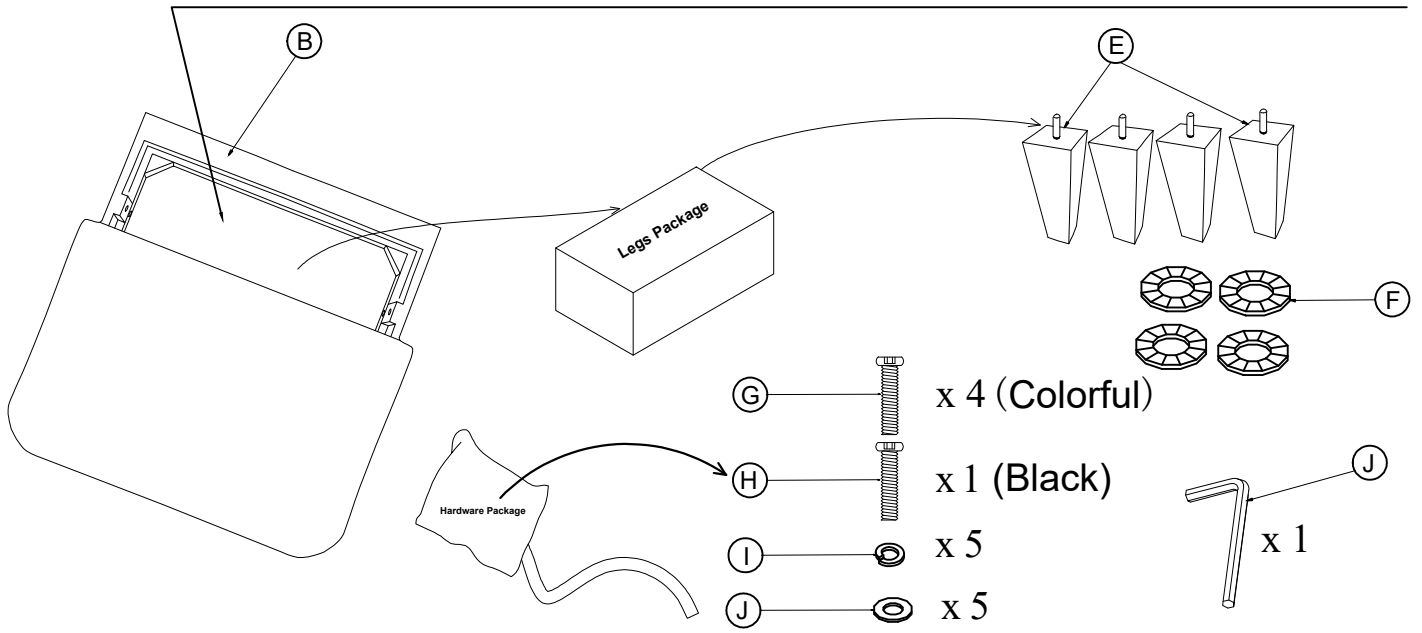

# Step #2

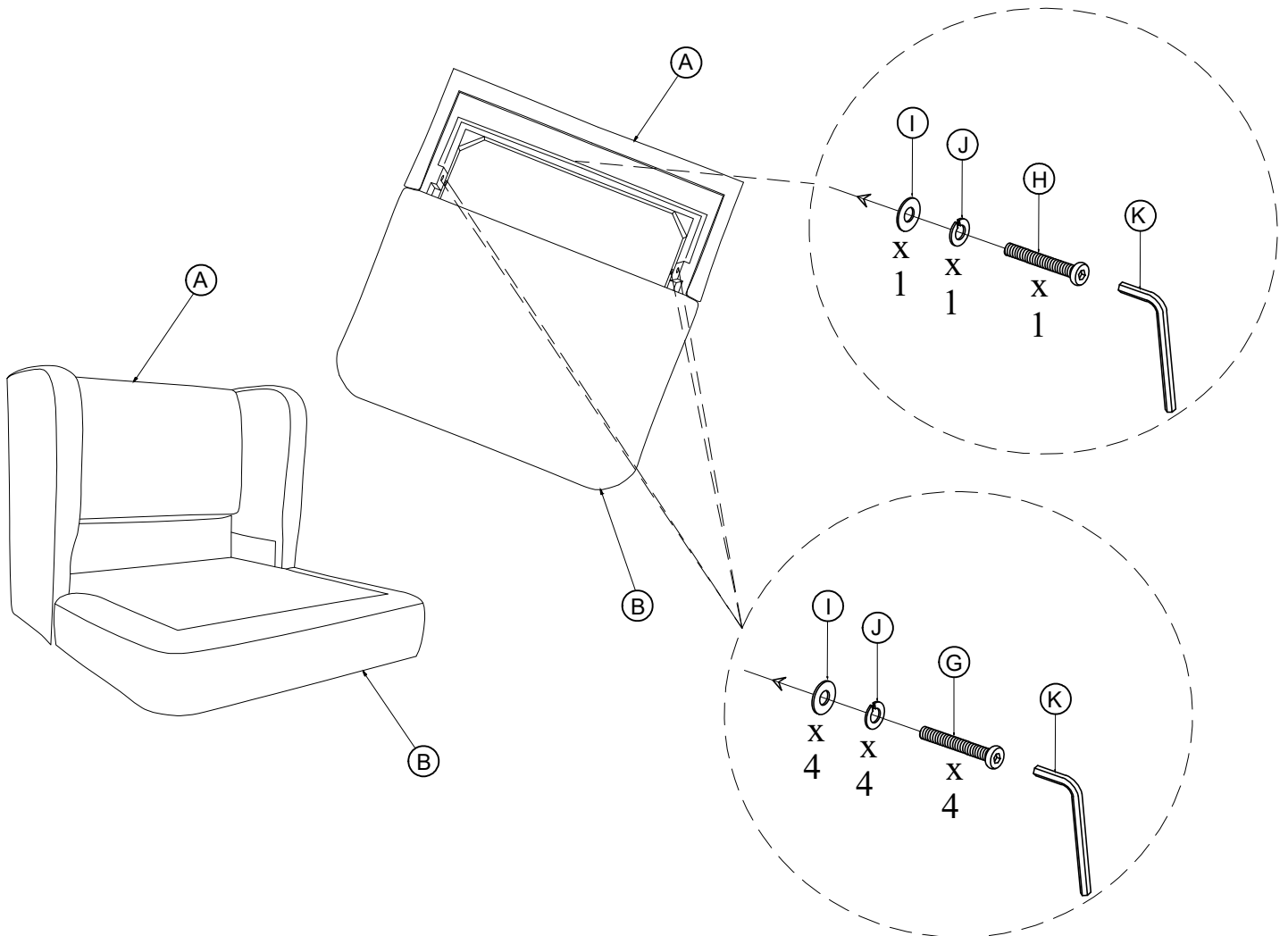

### Step #3

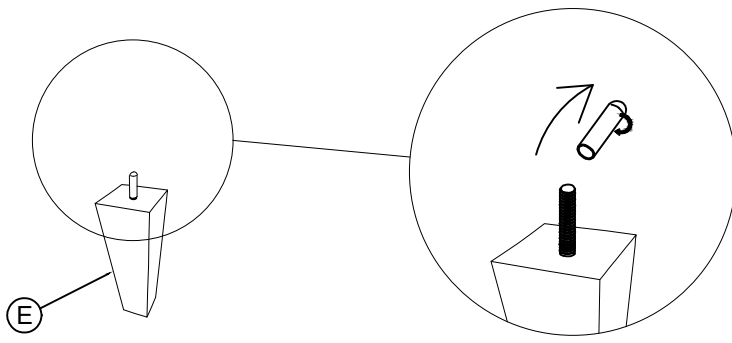

### Step #4

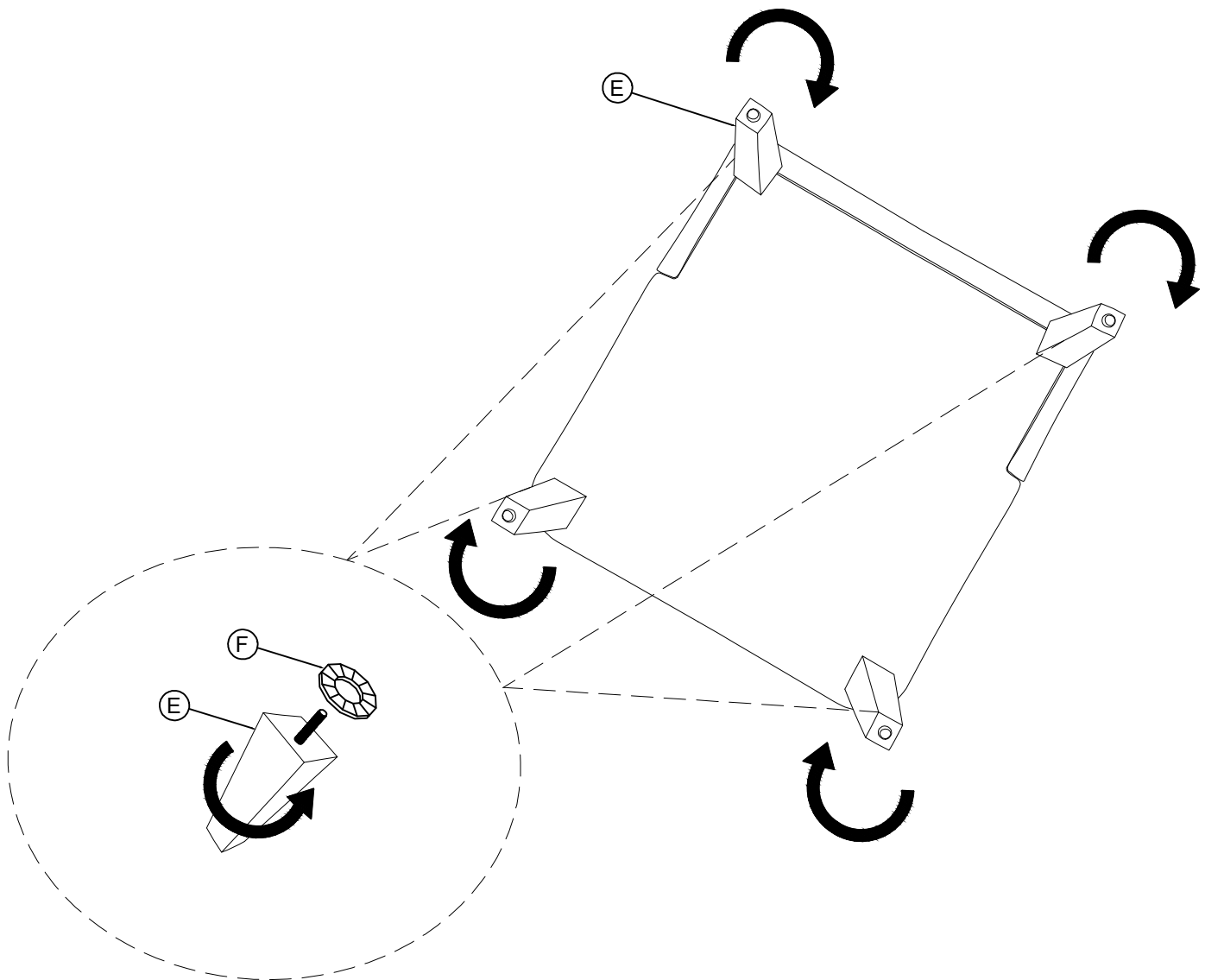

## Step #5

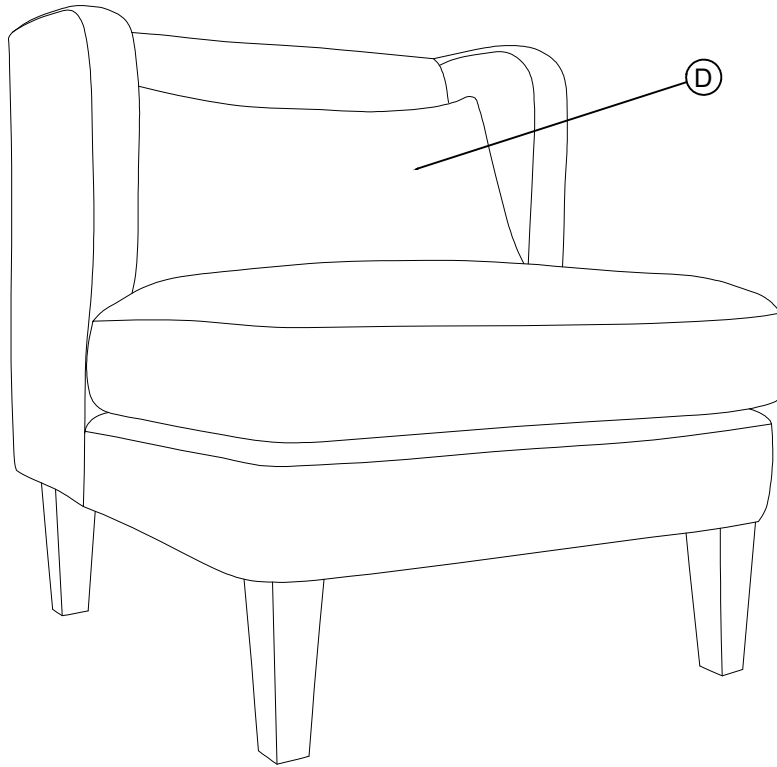

## Care Instruction for Corduroy Furniture:

In order to maintain the original appearance of your Corduroy Furniture, please follow below simple care procedures:

- Avoid exposing furniture directly to sunlight or heating and air conditioning outlets. Sunlight and or exposure to heating and air conditioning outlets will fade/damage Corduroy.
- Vacuum or wipe with a soft cloth to remove dust.
- Hardware may loosen over time. Periodically check to make sure all connection are tight, Re-tighten if necessary



For items use on wooden floor, hard surfaces or carpets, it is recommended to Install protective pads under all legs and supports to avoid/prevent from damages/scratches and discoloration.