

# MANUAL INSTRUCTION

**2 Pieces Outdoor Half-Moon Sectional  
Patio Furniture Set**

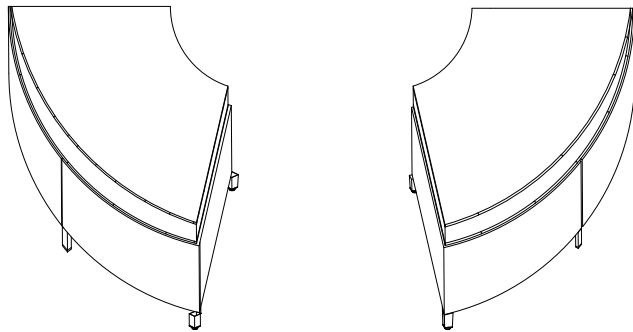

## **ATTENTION**

1. This patio furniture sofa set comes with 1 box, please check the parts list and hardware list carefully to make sure you've received all parts.
2. Be sure not to overtighten during installation, and never tighten all screw components until they are all installed on each seat.
3. If there are any missing parts, please contact us with-the missing part and the missing part number, we'll resend them to you ASAP.
4. If there are any damaged parts, please contact us with clear picture or clear video, we'll offer you the best solution after confirming it.

## **⚠️ WARRANTY AND RETURN**

- We offer 1 year warranty and free replacement for all damaged or defective parts you received. Check the condition of your package once upon the delivery.
- If you have any questions, please contact our customer service immediately.

## TOOLS REQUIRED



ALLEN WRENCH  
(WITH THE PRODUCT)



DO not use machine



2 Persons  
Assembly



Minimum  
60 Minutes  
For Assembly

## How To Cover Holes & Repair Broken Wicker

You can use two pieces PE wicker to cover the hole, and repeat the steps to cover all the holes. These PE wicker can also be used to repair the scratch or broken wicker.



Step 1



Step 2



Step 3



Step 4

# PARTS

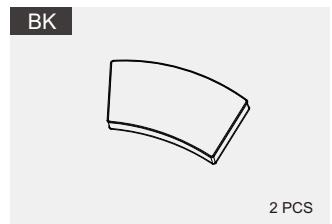
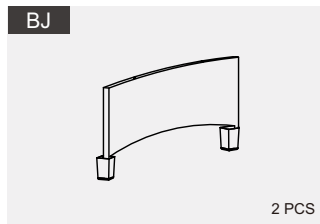
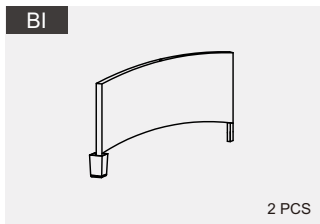
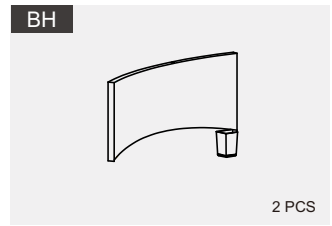
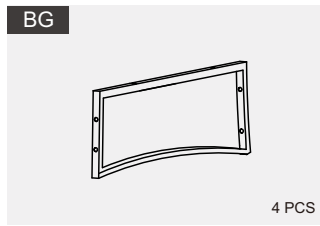
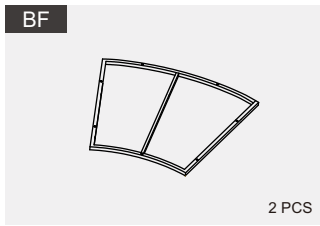

# HARDWARE

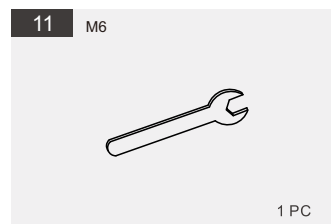
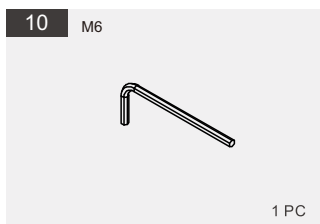
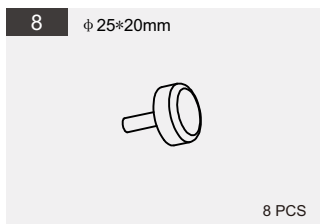
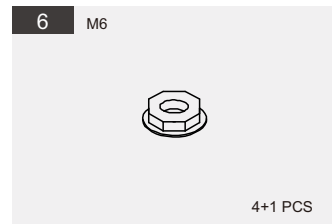
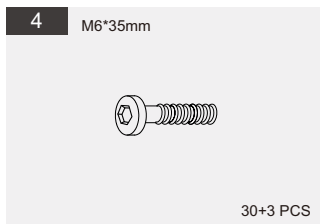
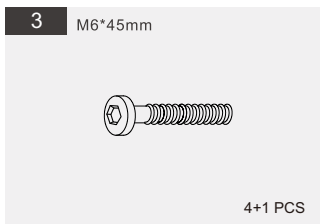

13





2 PCS

# PRODUCT ASSEMBLY Sector Bracket Assembly

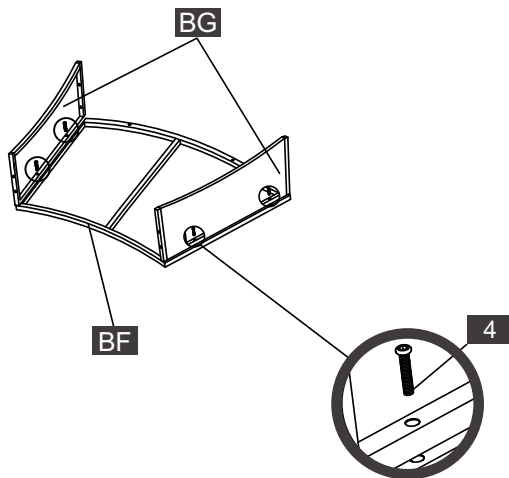
**1**





DO not use machine

PART	NO.	QTY.	PART	NO.	QTY.
	BF	1		4	4
	BG	2			

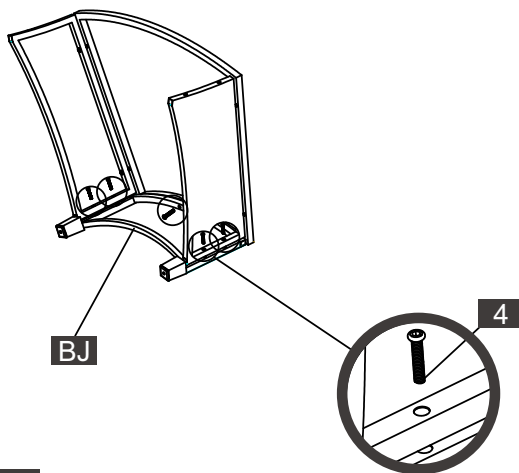
**2**





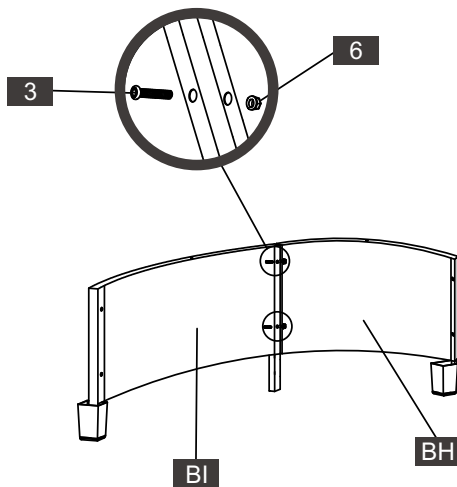

PART	NO.	QTY.
	BJ	1
	4	5

# I PRODUCT ASSEMBLY Sector Bracket Assembly

**3**



DO not use machine

PART	NO.	QTY.	PART	NO.	QTY.
	BI	1		3	2
	BH	1		6	2

**4**

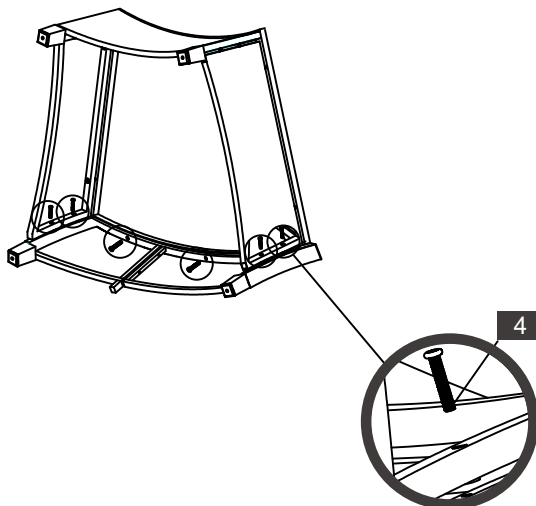

PART	NO.	QTY.
	4	6

# PRODUCT ASSEMBLY

## Sector Bracket Assembly

5



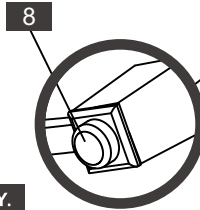
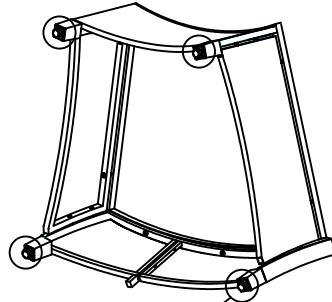

DO not use machine

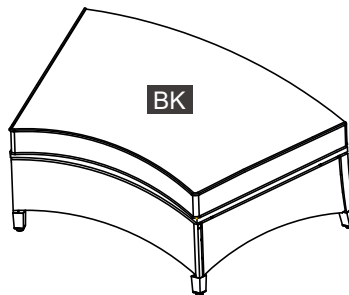

PART	NO.	QTY.
	8	4

6



PART	NO.	QTY.
	BK	1

# PRODUCT ASSEMBLY

## Sector Bracket Assembly

7



DO not use machine

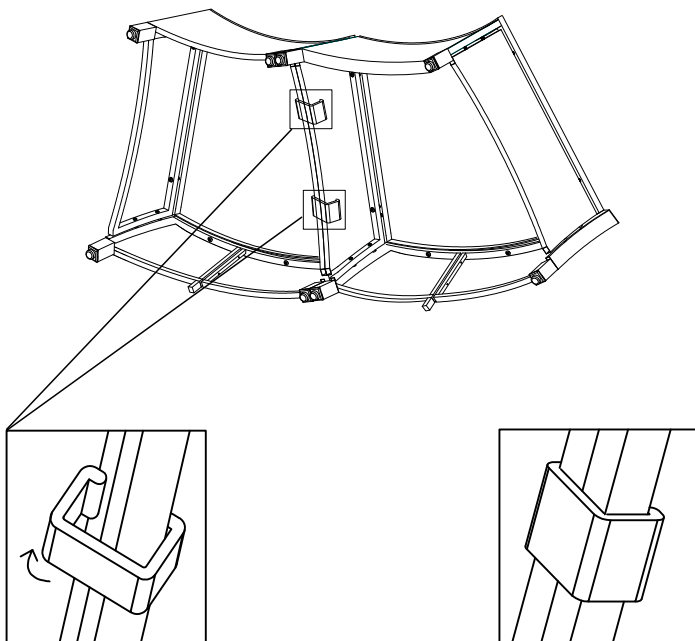

U-Shaped Connector x 2

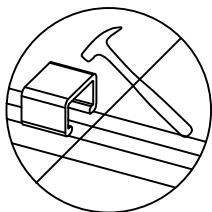

Notice:  
Do not use tools such as hammers;  
You can scald it with hot water to soften it.

PART	NO.	QTY.
	13	2

# PRODUCT ASSEMBLY

## Sector Bracket Assembly

8



DO not use machine

