

Owner's Manual And Assembly Instructions

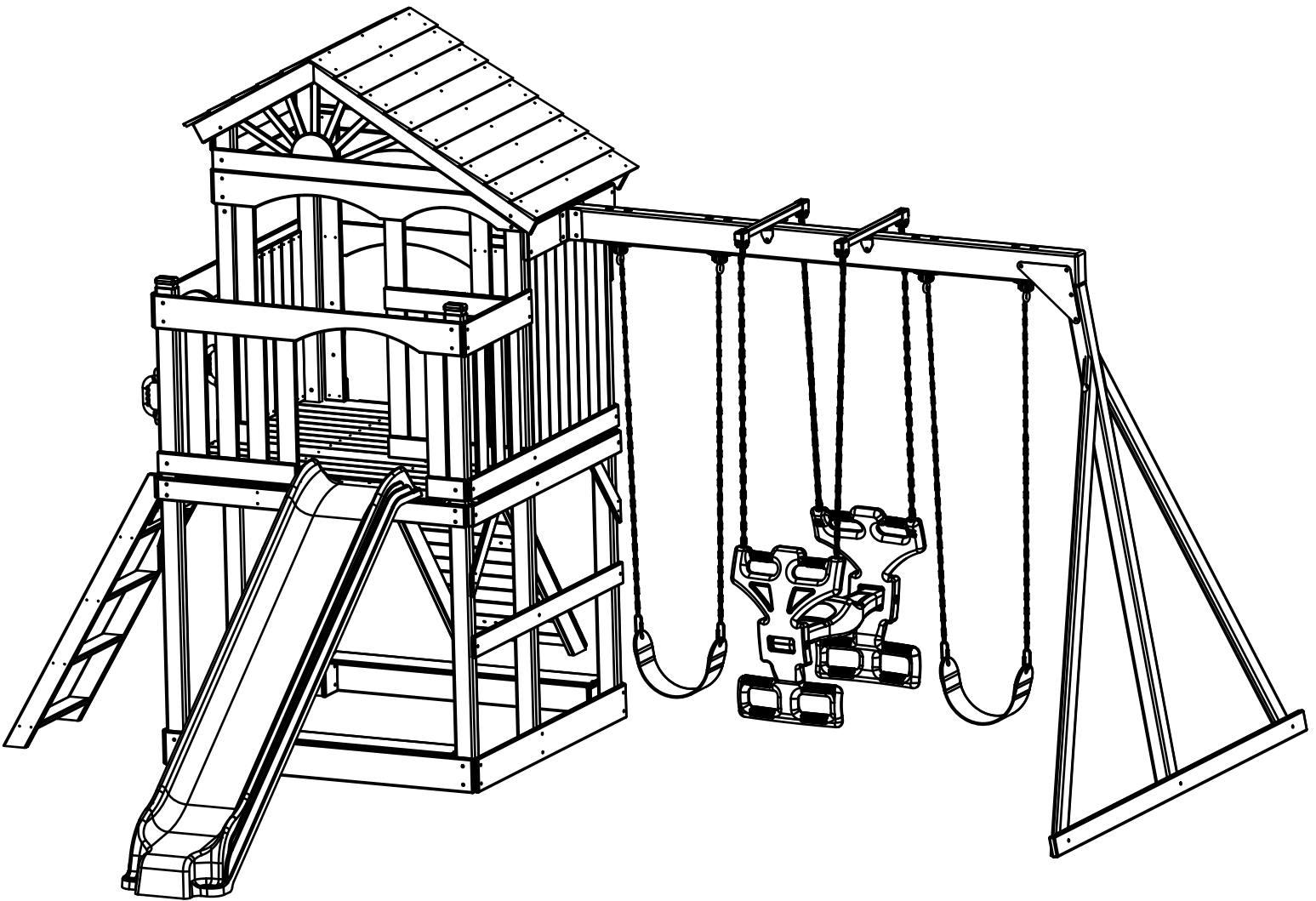

Timber Valley

Model: 3512



●.....●

**Thank you for purchasing a
Creative Cedar Designs
Playcenter. We hope it will
bring you and your children
many years of safe and
enjoyable backyard fun.**

●.....●

Table of Contents

Letter to Customer	2
Positioning Your Playcenter	3
Tools Required for Assembly	3
Helpful Installation Hints	4
Suggested Playground Surfacing	5
Operating Instructions	6
Maintenance Instructions	7
Disposal Instructions	7
CPSC Information Sheet	8
Assembly Instructions	9
Limited Warranty	42
Warranty Claim Procedure	43
Customer Registration Card	44

●.....●

**Your owner's manual should be read carefully
before starting assembly.**



STOP...PLEASE READ!!

IF YOU HAVE ANY QUESTION OR ARE MISSING A PART, PLEASE DO NOT CONTACT THE RETAILER THAT YOU PURCHASED THIS PRODUCT FROM. PLEASE VISIT www.creativecedardesigns.com

OR CONTACT US DIRECTLY AT OUR OFFICE, 1-888-363-4967

WE WILL ANSWER YOUR QUESTIONS, OR HELP WITH WHAT YOU NEED.

For more efficient service, please log onto our website at

www.creativecedardesigns.com

and fill out a request for missing or damaged parts. A completed product registration is also necessary for all warranty claims.

For all international customers, please visit the following website for information on all warranty issues including where to obtain replacement parts.

www.creativecedardesigns.com

Dear Customer:

Thank you for purchasing a Creative Cedar Designs Playcenter. We hope it will bring you and your children many years of safe and enjoyable fun. Creative Cedar Designs equipment is recommended for use by **children 3 to 10 years of age**. Creative Cedar Designs structures are **not intended for public use**. **Creative Cedar Designs does not warranty any of its residential structures subjected to commercial use.**



WARNING: This symbol points out important safety instructions which, if not followed, could endanger the personal safety of yourself and your children and/or damage your property. You **MUST** read and follow all instructions in this manual before attempting to use this playcenter.



WARNING: Children must **NOT** use this playcenter until unit has been completely assembled and inspected by an adult to insure set has been properly installed.

Please follow all recommendations below. **Failure to do so may result in the warranty being void and/or safety violations that could result in serious injury.** The following information has been provided to help you in your installation, continued satisfaction, and safe operation of your Creative Cedar Designs purchase.

Always keep the safety of your children in mind as your play structure is being built and as your children play on the set. Before your children play on the set please review the Operation Instructions with them to help ensure their safety.

PLEASE RETAIN THESE INSTRUCTIONS FOR FUTURE REFERENCE. KEEP THEM IN A SAFE PLACE WHERE YOU CAN REFER TO THEM AS NEEDED. IN ORDER TO PROVIDE YOU WITH THE MOST EFFICIENT SERVICE, IT IS REQUIRED THAT YOU PROVIDE US WITH THE PART NUMBERS WHEN ORDERING PARTS.

Please do **NOT** return the playcenter to the retailer from which it was purchased, without first contacting Customer Service.

General Information:

Please take time and fill out the information below. This information will be needed for warranty issues.

Date of Purchase: _____ **Date stamped on box:** _____

Manufacturer: Creative Cedar Designs **Retailer:** _____
PO Box 4901 _____
Chattanooga, TN 37405 _____

E-mail: custservice@creativecedardesigns.com

Website: www.creativecedardesigns.com

Unit Type:

Unit Name: Timber Valley Play Set

Revision Date: 12/13/2020

Unit Model Number: 3512

Maximum Fall Height: 6'-5"











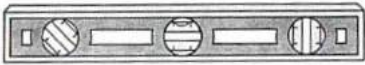

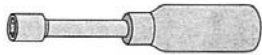
The instructions and owner’s manual for your new Playcenter should be read in its entirety before assembly, to minimize problems and safety issues. We recommend reading the owner’s manual thoroughly after you have identified all of the parts for your Playcenter as discussed in the Helpful Installations Hints section below.

Positioning Your Play center

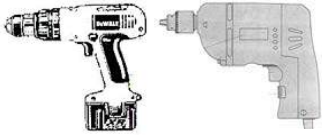
1. The Playcenter is designed to be installed on a level surface **by an Adult with an Adult helper**. Try to place in a flat area of your yard to minimize ground preparation.
2. Choose a level location for the equipment. This can reduce the likelihood of the play set tipping over and loose-fill surfacing material washing away during heavy rains.
3. Place the equipment not less than 6 ft from any structure or obstruction such as a fence, garage, house, overhanging branches, laundry lines, or electrical wires.
4. Provide enough room so that the children can use the equipment safely. For example, for structures with multiple play activities, a slide should not exit in front of a swing.
5. It is a good idea to place your Playcenter in an area that is convenient for adults to watch children at play.
6. Create a site free of obstacles that could cause injuries – such as low overhanging tree branches, overhead wires, tree stumps and/or roots, large rocks, bricks and concrete. We have additional suggestions in the Suggested Playground Surfacing Section.
7. Do not build your playset on top of surfacing material.
8. Locate bare metal platforms and slides out of direct sunlight to reduce the likelihood of serious burns. A slide that faces north will receive the least direct sunlight.
9. Separate active and quiet activities from each other. For example, locate sandboxes away from swings or use a guardrail or barrier to separate the sandbox from the movement of the swings.

Tools Required for Installation:

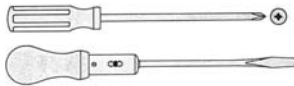
(These are the tools that are generally required for assembly of our playsets. These tools are not included in the playset purchase.)

			
Level 24"	Open End Wrenches (7/16" & 1/2")	Nut Drivers (1/2" & 9/16")	
			
Tape Measure	3/8" Drive Ratchet, (1/2" & 9/16") Std Socket & Deep Well	Claw Hammer	
			
3/8" Drill	Drill Bits (1/8", 5/16" & 3/8")	Drill attachments (3/8" Socket Driver Torque head screw)	Ladder
			
An Adult w/an Adult helper	Screw Drivers (Phillips & Straight)	Rubber Mallet (Optional)	

Helpful Installation Hints

1. Depending on your experience, assembly of this Play set should take approximately 6 to 12 hours after inventory of parts. Therefore, we recommend you set aside a full day for assembly.
2. Identify all of the parts for your Playcenter. Empty each box and lay out boards so you can see each part. Your instruction book will have detailed drawings that will make it easy for you to recognize individual parts. Keep all hardware and metal parts separate from wooden pieces.
3. After everything is laid out, check carefully to ensure all parts are present. Make sure there are no broken boards.
4. Find an area to sort your hardware. It is best to open the hardware on a solid surface so that you do not lose any pieces in the grass. This will save time and familiarize you with all the different pieces in the hardware bag.
5. Important note: Wood has some natural defects such as knots, surface cracks, etc... We reject parts that are structurally defective. We use a high quality lumber in our structures; however, you should inspect each part for splinters or rough spots and sand them smooth to prevent injury.
6. After steps 1 thru 4 have been completed, read all the way through the instructions completely. Reading instructions after you have studied the parts will help you understand more clearly the installation process, and help to eliminate unnecessary mistakes.
7. Pay close attention to the diameter and length of each bolt and screw.
8. Swing hangers should be buried past the threads, so that the loop is against the swing beam. Creative Cedar Designs is not responsible for incorrect installations of swing hangers. Failure to properly install swing hangers may cause severe injury.
9. Never tighten hardware completely at first. It helps to have some adjustment for bolt alignment while you are attaching parts together. After everything is square, tighten each joint.
10. After the main unit is assembled it is critical that the floor is level and square. If the main frame is not level, the walls and floor will be out of square.
11. After you complete installation, make sure every bolt, screw, and nut is tight, and every board is secure. Wood will expand and contract with the seasons. Check all bolt connections and swing hangers every two weeks.
12. Place the set on level ground, not less than 6ft from any structure or obstruction such as a fence, garage, house, overhanging branches, laundry lines, or electrical wires.

READ! VERY IMPORTANT!

If you are missing parts or have questions regarding the installation of our quality product PLEASE call us directly at our offices (1-888-363-4967). Our trained staff will be happy to assist you.

Customer service hours:

**Monday thru Friday 9am to 4pm
Eastern Standard Time.**

E-mail: custservice@creativecedardesigns.com

Suggested Playground Surfacing

- ❑ Playground equipment should never be placed on hard surfaces such as concrete or asphalt.
- ❑ Do not install loose fill surfacing over hard surfaces such as concrete or asphalt.
- ❑ Shredded bark mulch, wood chips, fine sand and fine gravel, are added as shock absorbing materials after assembly. If used properly these materials can absorb some of the impact of a child’s fall.
- ❑ All surface material should extend a minimum of 6 feet in all directions around the play area.
- ❑ Do not apply playground surfacing until after the unit is completely constructed. Playset should not be built on top of surfacing.
- ❑ Use containment, such as digging out around the perimeter and/or lining the perimeter with landscape edging.
- ❑ Installation of rubber tiles or poured-in-place surfaces (other than loose-fill materials) generally require a professional and are not “do-it-yourself” projects.
- ❑ Shall use Playground Surfacing Materials (other than loose-fill material) which comply to the safety standard ASTM F1292 Standard Specification of Impact Attenuation of Surfacing Materials within the Use Zone of Playground Equipment.

The following chart explains the fall height in feet from which a life threatening head injury would not be expected
Critical Heights in feet (m) of Tested Materials

Material	Uncompressed Depth			Compressed Depth
	6" (152mm)	9" (228mm)	12" (304mm)	to 9" (228mm)
Wood Chips	7' (2.13m)	10' (3.05m)	11' (3.35m)	10' (3.05m)
Double-Shredded bark mulch	6' (1.83m)	10' (3.05m)	11' (3.35m)	7' (2.13m)
Engineered Wood Fibers	6' (1.83m)	7' (2.13m)	>12' (3.66m)	6' (1.83m)
Fine Sand	5' (1.52m)	5' (1.52m)	9' (2.74m)	5' (1.52m)
Coarse Sand	5' (1.52m)	5' (1.52m)	6' (1.83m)	4' (1.22m)
Fine Gravel	5' (1.52m)	7' (2.13m)	10' (3.05m)	6' (1.83m)
Medium Gravel	5' (1.52m)	5' (1.52m)	6' (1.83m)	5' (1.52m)
Shredded Tires*	10-12' (3.0-3.6m)	N/A	N/A	N/A

*This data is from tests conducted by independent testing laboratories on a 6-inch depth of uncompressed shredded tire samples produced by four manufacturers. The tests reported critical heights, which varied from 10 feet to greater than 12 feet. It is recommended that persons seeking to install shredded tires as a protective surface request test data from the supplier showing the critical height of the material when it was tested in accordance with ASTM F1292.

Operating Instructions:



NOTE: Your children's safety is our #1 concern. Observing the following statements and warnings reduces the likelihood of serious or fatal injury. Please review these safety rules regularly with your children.

1. This Playcenter is designed for the use of 6 occupants, who have a combined weight **not exceeding** 420 pounds, 4 occupants on the swing area, who have a combined weight of 350 pounds, for a total unit capacity of 10 occupants who have a combined total weight of 770 pounds.
(this weight is not including the sand box area)
2. On-site adult supervision is **required**.
3. Instruct children **not** to walk close to, in front of, behind, or between moving swings or other moving playground equipment.
4. Instruct children to sit in and **never** stand on swings
5. Instruct children **not** to twist the chains and ropes and not to loop them over the top support bar, since this may reduce the strength of the chain or rope.
6. Instruct children **not** to jump from swings or other playground equipment in motion.
7. Instruct children to **not push** empty seats. The seat may hit them and cause serious injury.
8. Instruct and teach children to sit in the center of the swings with their full weight on the seats.
9. Instruct children **not** to use the equipment in a manner other than intended.
10. Instruct children to **always** go down slides feet first. Never slide headfirst.
11. Instruct children to **look** before they slide to make sure no one is at the bottom.
12. Instruct children to **never** run up a slide, as this increases their chances of falling.
13. The parents should have the children **dress appropriately** with well-fitting shoes. Loose clothing such as scarves and ponchos should not be worn. Always take off, tie up or tuck in cords and drawstrings on children's clothing. These things can get caught on playground equipment and strangle a child.
14. Instruct children **not** to climb when the equipment is wet.
15. Instruct children to **never** jump from a fort deck. They should always use the ladder, ramp or slide.
16. Instruct children to **never** crawl on top of a fort roof.
17. Verify that any suspended climbing ropes, chain, or cable are secured at both ends and that they cannot be looped back on it.
18. Instruct children **not** to attach items to the playground equipment that are not specifically designed for use with the equipment, such as, but not limited to, jump ropes, clothesline, pet leashes, cables, and chain as they may cause a strangulation hazard.
19. Instruct children to **never** wrap their legs around swing chain.
20. Instruct children to **never** slide down the swing chain.

Maintenance Instructions:

1. Check all nuts and bolts twice monthly during the usage season and tighten as required. (But not so tight that you crack the wood) We recommend you check the swing beam and hardware every two weeks due to wood expansion and contraction. It is particularly important that this procedure be followed at the beginning of each season.
2. Remove plastic swing seats and take indoors or do not use when the temperature drops below 32 °F.
3. Oil all metallic moving parts monthly during the usage period.
4. Check all coverings for bolts and sharp edges twice monthly during usage season to be certain they are in place. Replace when necessary. It is especially important to do this at the beginning of each new season.
5. Check swing seats, ropes, cables and chains monthly during usage season for evidence of deterioration. Replacement should be made of any swing seat that has developed cracks in the plastic seats or has exposed metal in the edges of the swing seat. If there are already exposed metal inserts on the edge of the seat, immediately remove the seats and chains to prevent serious injury. Ropes, cables and chains should be removed and replaced if excessive wear is found. Contact Creative Cedar Designs for replacement parts.
6. For rusted areas on metallic members such as monkey bars, hand supports, brackets, etc., sand and repaint, using a non lead-based paint meeting the requirements of Title 16 CRF Part 1303.
7. Inspect wood parts monthly. The grain of the wood sometimes will lift in the dry season causing splinters to appear. Light sanding may be necessary to maintain a safe playing environment. If you are treating your Playcenter with stain regularly, it will help prevent severe checking/splitting and other weather damage.
8. We have applied a waterborne transparent stain to your unit. This is done for color only. Once or twice a year, depending on your climate conditions, you must apply some type of protection (sealant) to the wood of your unit. Prior to the application of sealant, lightly sand any “rough” spots on your set. Please note this is a requirement of your warranty.
9. Creating and maintaining the Playcenter on a level location is very important. As your children play, your Playcenter will slowly dig its way into the soil, and it is very important that it settles evenly. Make sure the play set is level and true once each year or at the beginning of each play season.
10. Rake the surface periodically to prevent compaction and maintain appropriate depths.

Disposal Instructions:

When the Playcenter use is no longer desired, it should be disassembled and disposed of in such a way that no unreasonable hazards will exist at the time the unit is discarded.

APPENDIX A

Information on Playground Surfacing Materials:

The following information is from the *United States Consumer Product Safety Commission's Information Sheet for playground surfacing material*. Also see the following website for additional information: <https://www.cpsc.gov/PageFiles/122146/324.pdf>

X3. SECTION 4 OF THE CONSUMER PRODUCT SAFETY COMMISSION 'S OUTDOOR HOME PLAYGROUND SAFETY HANDBOOK⁹

X3.1.1.1 Maintain a minimum depth of 9 inches of loosefill materials such as wood mulch/chips, engineered wood fiber (EWF), or shredded/recycled rubber mulch for equipment up to 8 feet high; and 9 inches of sand or pea gravel for equipment up to 5 feet high. NOTE: An initial fill level of 12 inches will compress to about a 9- inch depth of surfacing over time. The surfacing will also compact, displace, and settle, and should be periodically refilled to maintain at least a 9 - inch depth.

X3.1.2 Use a minimum of 6 inches of protective surfacing for play equipment less than 4 feet in height. If maintained properly, this should be adequate. (At depths less than 6 inches, the protective material is too easily displaced or compacted.) NOTE: Do not install home playground equipment over concrete, asphalt, or any other hard surface. A fall onto a hard surface can result in serious injury to the equipment user. Grass and dirt are not considered protective surfacing because wear and environmental factors can reduce their shock absorbing effectiveness. Carpeting and thin mats are generally not adequate protective surfacing. Ground level equipment-such as a sandbox, activity wall, playhouse or other equipment that has no elevated play surface-does not need any protective surfacing.

X3.1.3 Use containment, such as digging out around the perimeter and/or lining the perimeter with landscape edging. Don ' t forget to account for water drainage.

X3.1.3.1 Check and maintain the depth of the loose-fill surfacing material. To maintain the right amount of loose- fill materials, mark the correct level on play equipment support posts. That way you can easily see when to replenish and/or redistribute the surfacing.

X3.1.3.2 Do not install loose fill surfacing over hard surfaces such as concrete or asphalt.

X3.1.4 Poured-In-Place Surfaces or Pre-Manufactured Rubber Tiles -You may be interested in using surfacing other than loose-fill materials-like rubber tiles or poured-in-place surfaces.

X3.1.4.1 Installations of these surfaces generally require a professional and are not "do-it-yourself" projects.

X3.1.4.2 Review surface specifications before purchasing this type of surfacing. Ask the installer/manufacture for a report showing that the product has been tested to the following safety standard: ASTM F 1292 Standard Specification for Impact Attenuation of Surfacing Materials within the Use Zone of Playground Equipment. This report should show the specific height for which the surface is intended to protect against serious head injury. This height should be equal to or greater than the fall height-vertical distance between a designated play surface (elevated surface for standing, sitting, or climbing) and the protective surfacing below of your play equipment.

X3.1.4.3 Check the protective surfacing frequently for wear.

X3.1.5 Placement—Proper placement and maintenance of protective surfacing is essential. Be sure to:

X3.1.5.1 Extend surfacing at least 6 feet from the equipment in all directions.

X3.1.5.2 For to-fro swings, extend protective surfacing in front of and behind the swing to a distance equal to twice the height of the top bar from which the swing is suspended.

X3.1.5.3 For tire swings, extend surfacing in a circle whose radius is equal to the height of the suspending chain or rope, plus 6 feet in all directions.

Timber Valley Play Set Assembly Instructions

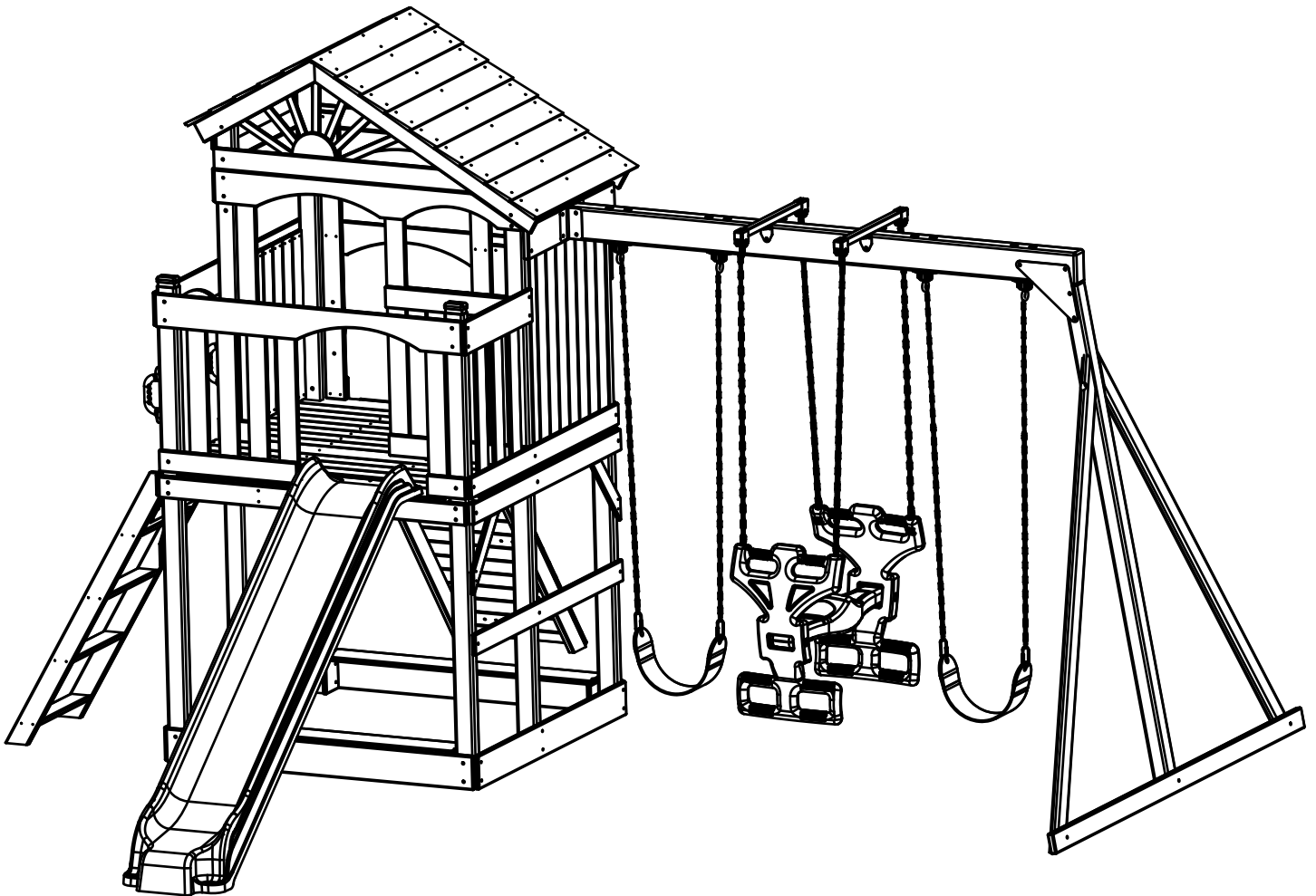

WARNING: CHOKING HAZARD
Unassembled parts may be a choking hazard to children 3 years and younger



CAUTION: Adult Assembly Required.
Hardware contains small pieces with sharp points. Keep parts out of the reach of children until assembled. Parts of this product can present dangers if improperly assembled.



CAUTION: The plastic bags that contain the hardware may present a choking hazard to small children. Please keep these bags and all plastic bags out of the reach of children. Do not allow children to play with them and dispose of them immediately when empty.

Basic Setup Dimensions

Place the set on level ground, not less than 6ft (1.83M) from any structure or obstruction such as a fence, garage, house, overhanging branches, laundry lines or electrical wires.

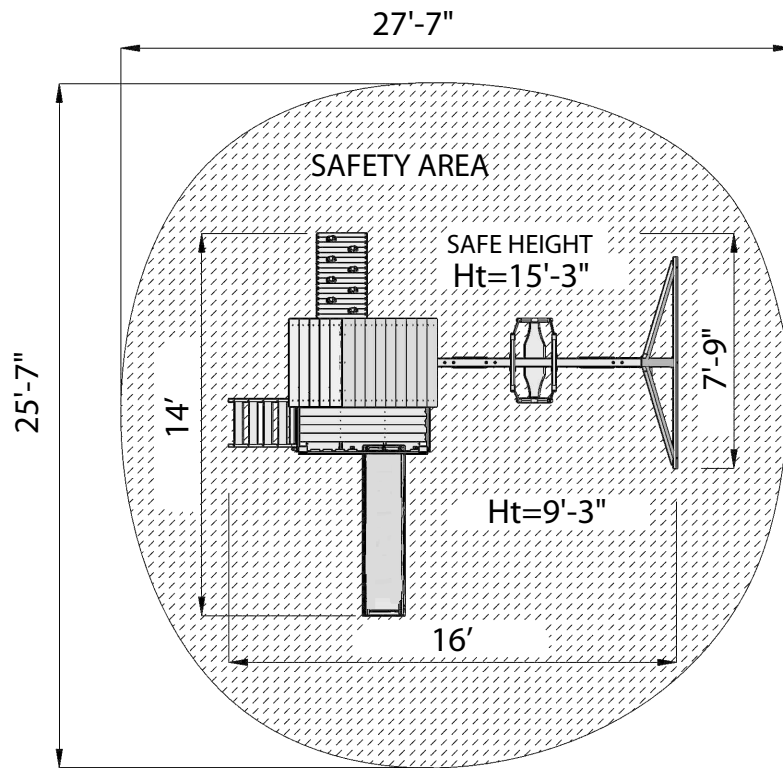

Important Assembly Notes

- 1) While assembling unit, take time before and after each phase to make sure Fort is level. If fort is not level, assembly will be difficult and improper assembly may result. Extra care must be taken to assure the fort is square on the phases that include this symbol in Fig i.
- 2) When installing a board on the small face of a 2x4, pre-drilling the attachment hole is **REQUIRED**. Just place the board where attachment is needed and by using the holes in the board as a guide, drill holes into the 2x4 with a $\frac{1}{8}$ " drill bit $1\frac{1}{4}$ " deep. Failure to Pre-drill may result in board splitting

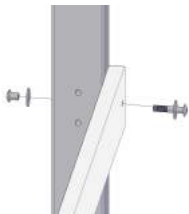
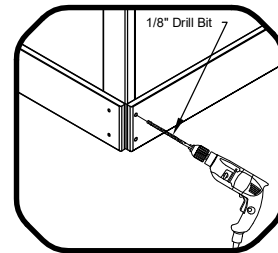
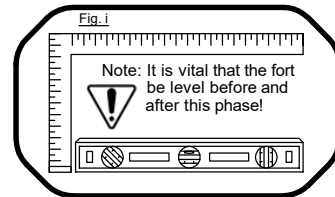

- 3) Whenever a T-nut is used, follow these directions. Place t-nut in pre-drilled hole. Tap in with hammer. Place bolt with split and flat washers in the] opposite side. Hand tighten to make sure the bolt is in the t-nut. Secure with socket. **DO NOT Over Tighten.**

- 4) Pay close attention to the "Items needed" and "Hardware needed" sections of each phase. They can be a valuable aid when sorting your wood and hardware. Assembly will be made easier if items are sorted by phase.
- 5) Pay close attention to make sure you are using the correct hardware in the correct places. Using incorrect hardware may result in improper assembly.
- 6) Read the steps of each phase thoroughly. The written steps may include important information not shown in the illustrations.

Parts Identification

Wood Components

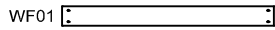

(2) Sandbox board-A 1x6x54

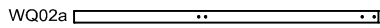

(1) Upright-A 3x4x78 3/4

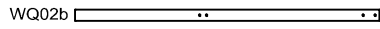

(1) Upright-B 3x4x78 3/4

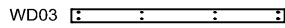

(2) End Floor Support 5/4x4x54

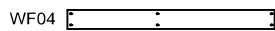

(2) Sandbox Board-B 1x6x52 13/16

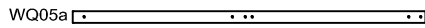

(1) Upright-C 3x4x89 5/16

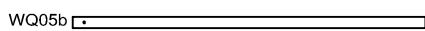

(1) Upright-D 3x4x89 5/16

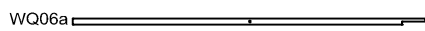

(1) Upright-E 3x4x89

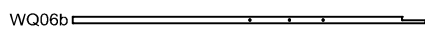

(1) Upright-F 3x4x89

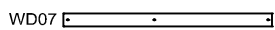

(2) Floor Joist 5/4x4x52 13/16

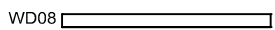

(2) Floor Support 1x4x52 3/4

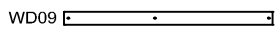

(2) First Floor Guardrail 1x4x52 13/16



(4) Sandpit Seat Support 1x6x4 1/2

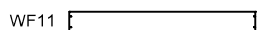

(2) Sandbox Seat 1x6x47 1/4

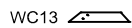

(4) Platform Support 1x3x15 5/16

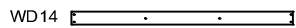

(11) Floor Board-A 1x4x56 1/8

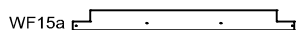

(1) Floor Board-B 1x4x56 1/8

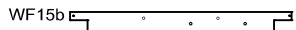

(1) Floor Board -C 1x4x56 1/8

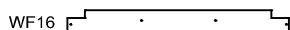

(1) Floor Board-D 1x6x56 1/8

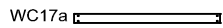

(1) Wall Slat-A 1x3x37

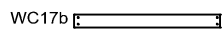

(7) Wall Slat-B 1x4x37



(2) Slide Support Board 11/16 X 3 1/2 X 12



(2) Top Double Arch Board 1x6x54

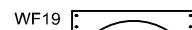

(1) Top Arch Board 1x6x31

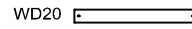

(1) Top Brace 1x4x31



(2) Playhouse Arched Guardrail-A 1x6x54



(4) Tower Surrounded Board 1x4x24 3/8

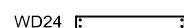

(25) Playhouse Wall Slat-A 1x4x27 9/16

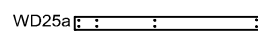

(1) Playhouse Wall Slat-B 1x4x46 3/4

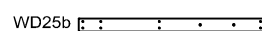

(2) Playhouse Wall Slat-C 1x4x46 3/4

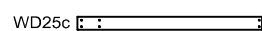

(1) Playhouse Wall Slat-E 1x4x46 3/4

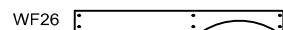

(1) Playhouse Arched Guardrail-B 1x6x52 13/16



(1) Gazebo Guardrail 1x6x23 29/32

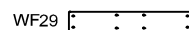

(1) Swing Attached Board 5/4x6x31

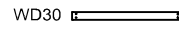

(1) Playhouse Wall Slat-D 1x3x27 9/16

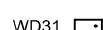

(3) Tower Surrounded Board-C 1x4x6 27/32

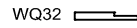

(2) Upright-G 3x4x15 29/32

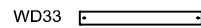

(1) Tower Surrounded Board-D 1x4x31

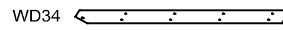

(1) Ladder Rail(Left) 5/4x4x54 3/8

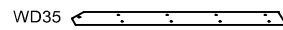

(1) Ladder Rail(Right) 5/4x4x54 3/8

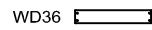

(4) Ladder Step 1x6x23 29/32

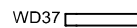

(1) Ladder Block 1x4x20

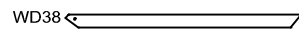

(2) Rockwall Rail 5/4x4x59 3/4

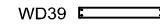

(8) Rock Board-A 1x4x21

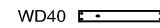

(8) Rock Board-B 1x4x21

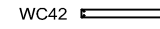

(1) Rock Board-C 1x3x21

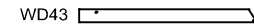

(2) Sunburst Frame-A 1x4x45

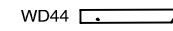

(2) Sunburst Frame-B 1x4x25

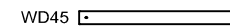

(2) Sunburst Frame-C 1x4x45 7/16

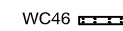

(2) Roof Brace Fixed 1x3x11 7/16



(2) Sunburst DecoBoard 1x4x4 7/8

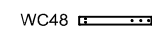

(2) Sunburst Trim-A 1x2x18 5/16

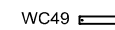

(4) Sunburst Trim-B 1x3x9 27/32

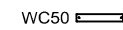

(4) Sunburst Trim-C 1x3x11 13/16



(1) Roof Beam-A 2x2x31

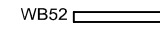

(1) Roof Beam-B 1x2x19 7/8

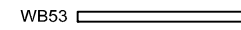

(1) Roof Beam-C 1x2x40 15/16

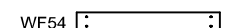

(12) Roof Board-A 1x6x36 5/16

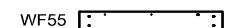

(2) Roof Board-B 1x6x36 5/16

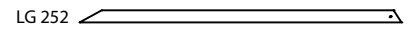

(2) Swing Leg-A 2x4x82 1/2

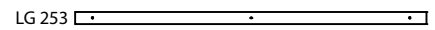

(1) Swing Ground Support 2x4x89

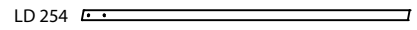

(1) Swing Leg-B 3x4x83

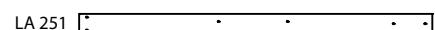

(1) Swing Beam 4x6x89 1/2

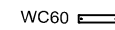

(4) Sunburst Trim-D 1x3x13

Parts Identification

Accessories

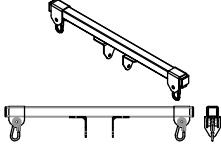

(1 - PAIR) GLIDER SUPPORT ASSEMBLY - BP020



(1) ID-TAG
w/ HARDWARE



(4) SWING HANGER
KC 003
w/ HARDWARE



(2) 4 COUNT BAGS CLIMBING ROCKS
BP011-GYBR w/ HARDWARE



(14) GREEN L-BRACKET
M003



(2) GREEN ANGLE BRACKET
M005

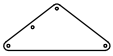

(2) 100° TRIANGLE PLATE - M100

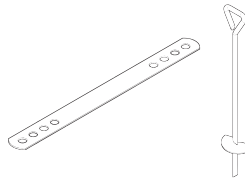

(2) ANCHOR 4-PACK
BP001-B
w/ HARDWARE

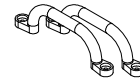

(1 - PAIR) SAFETY HANDLE
w/ WOOD SCREWS
BP 007-Y

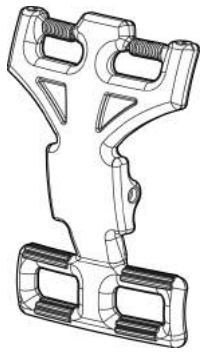

(2) GLIDER ARM



(1) GLIDER SEAT

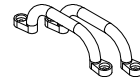

(1 - PAIR) SAFETY HANDLE
w/ T-NUTS
BP 007T-Y



(4) CHAIN w/ EYE BOLT

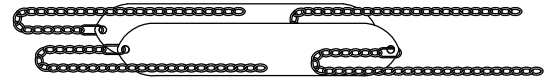

(2) ULTIMATE SWING SEAT
BP014-Y

(1) GLIDER - BP 018-GY
w/ HARDWARE



(1) 8' SLIDE

Hardware Identification

2 1/2" Wood Screws



1 3/4" Wood Screws



1 1/8" Wood Screws



7/8" Wood Screws

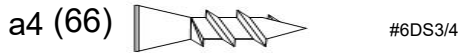

5/16" x 3 1/2" Hex Head Screws



5/16" x 1 3/4" Hex Head Screws



1" Truss Head Screws

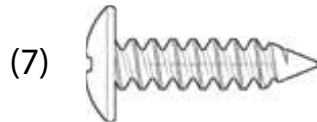

5/8" Tapping Screws

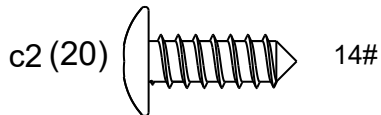

5/16" x 4 1/4" Hex-Head Bolt

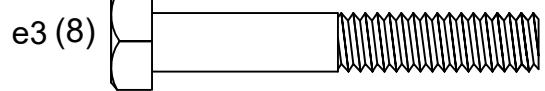

5/16" x 2 3/4" Hex-Head Bolt

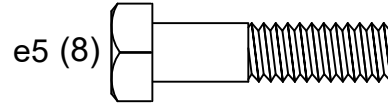

5/16" x 2 1/2" Hex-Head Bolt

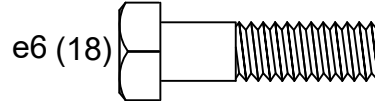

5/16" x 1 3/4" Hex-Head Bolt

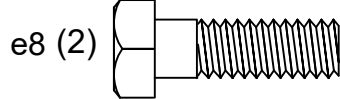

5/16" x 1" Hex-Head Bolt

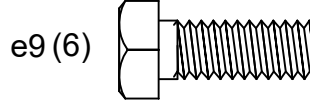

1/4" x 2" Button Head Bolts

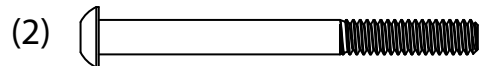

Hardware Identification

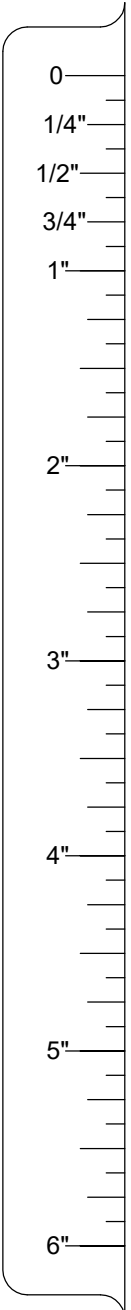
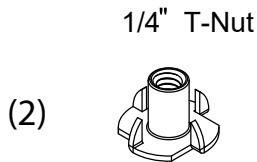
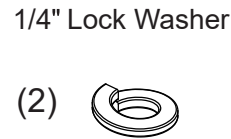
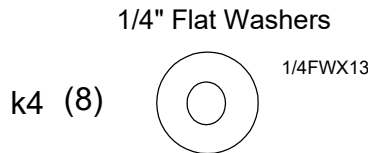
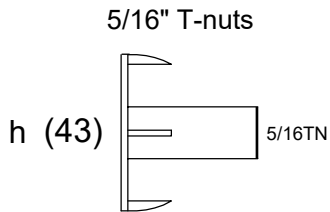
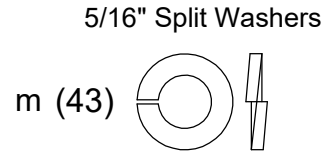
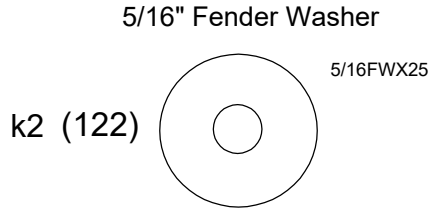
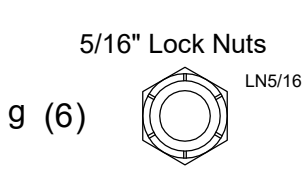
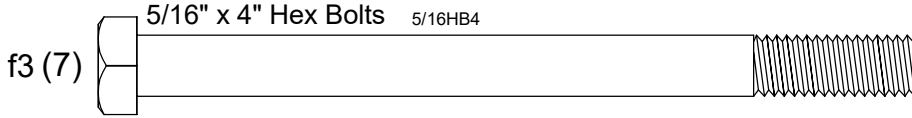

Measuring hardware

It is very important that you get the right hardware in the correct place when assembling the unit. You can compare the hardware to the hardware identification page.

NOTES:

- 1) Do not include bolt head when measuring length of bolt.
- 2) Include full length of deck screw when measuring.

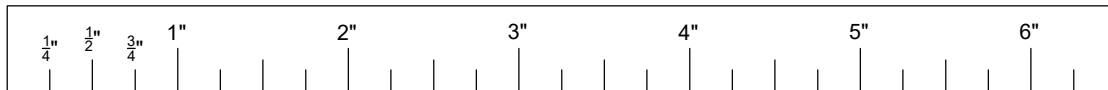
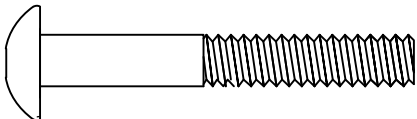

Quick Overview of Parts

FRONT

RIGHT

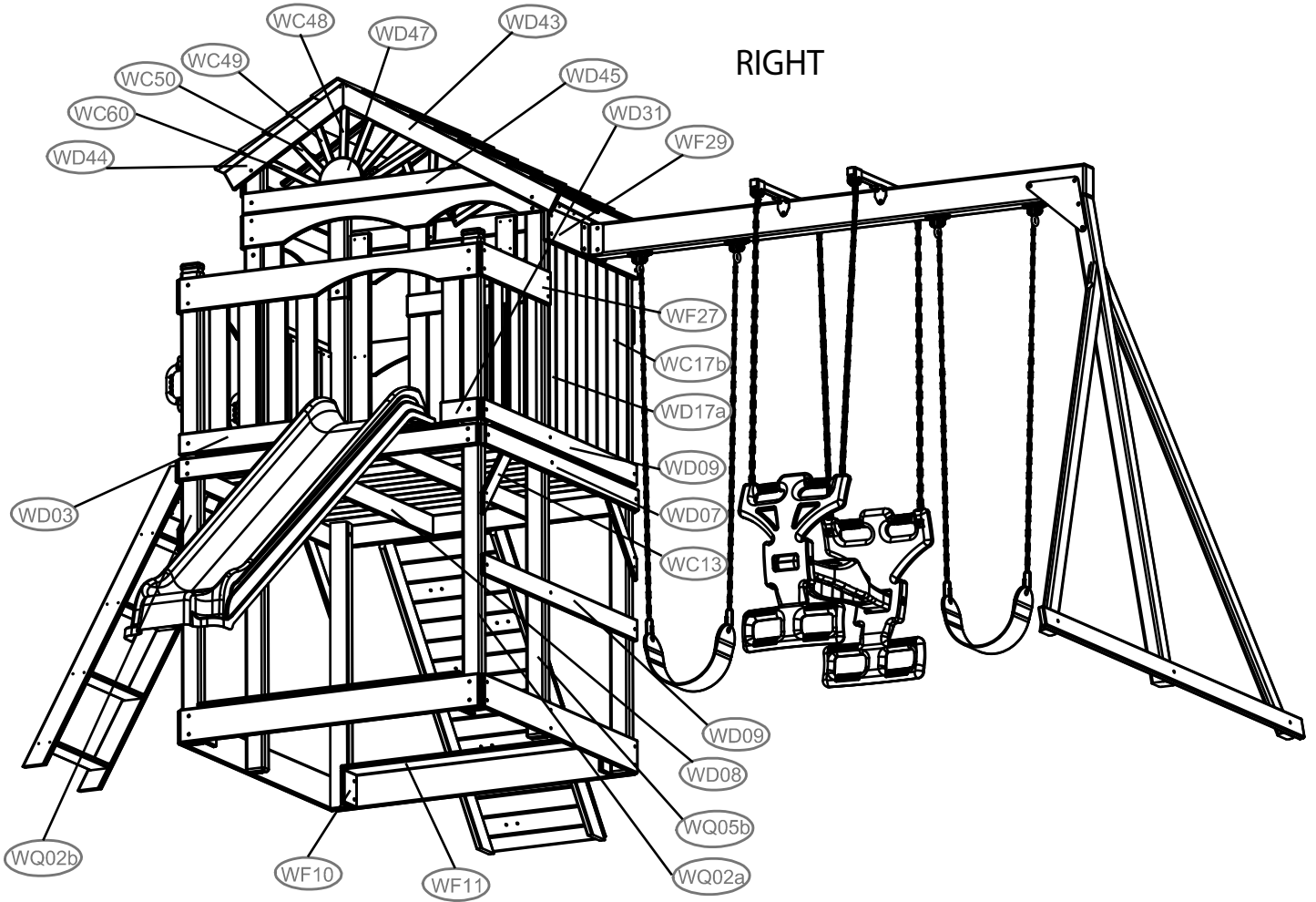

Quick Overview of Parts

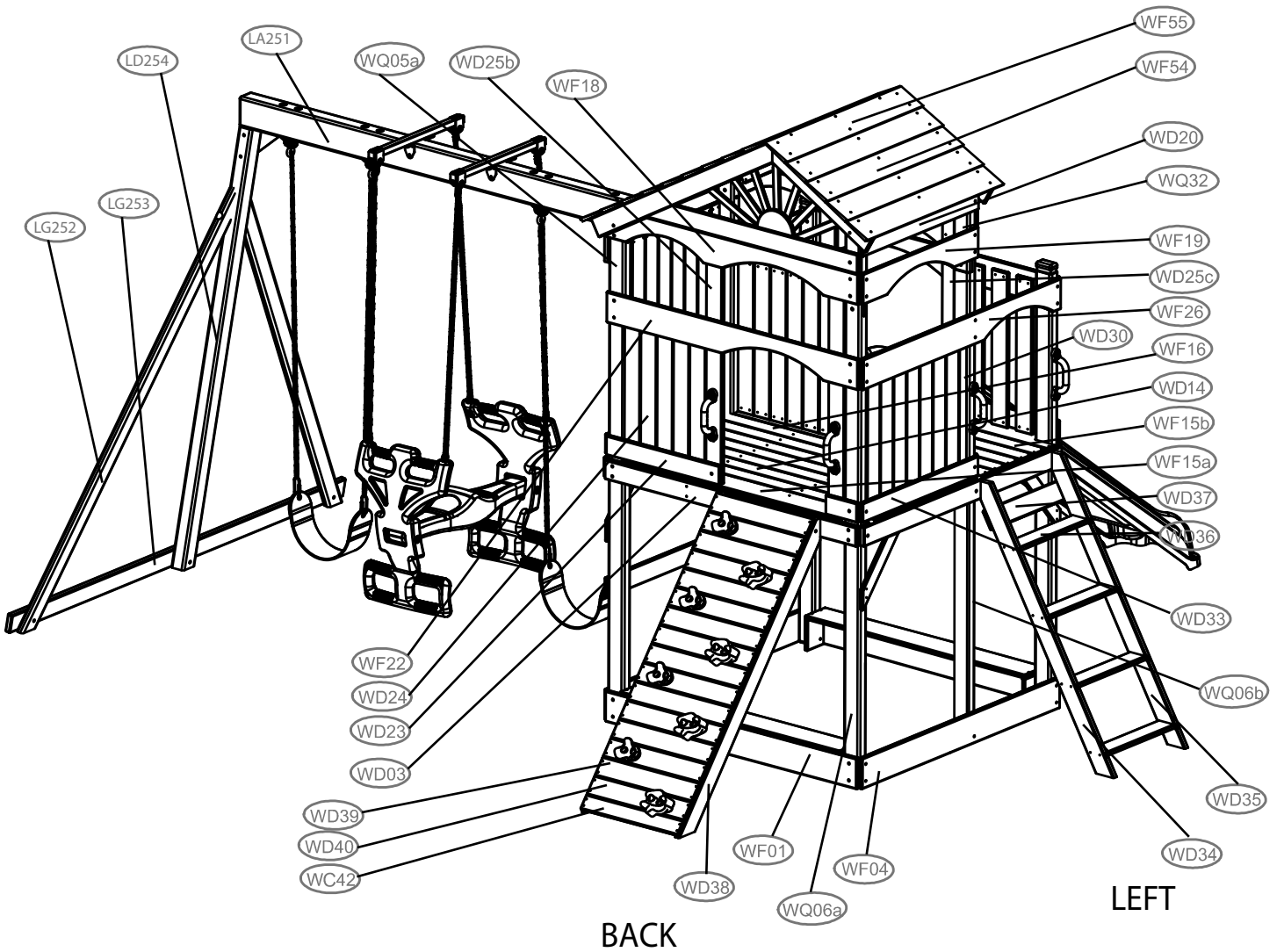
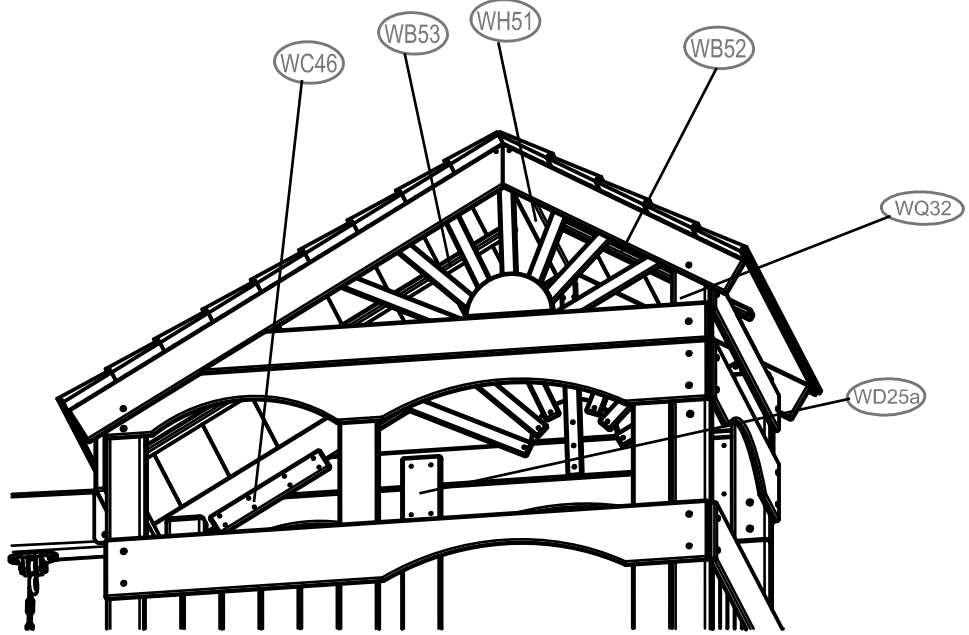

TOWER ASSEMBLY

STEP 1:

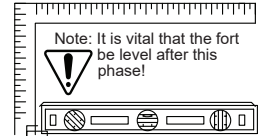

- * Insert all T-Nuts "h" into the uprights respectfully.
- * Lay out WQ02a, WQ05b and WQ05a as shown.
- * Attach WD07 into the pre-drilled holes with bolt "e3".
- * Attach WD04 into the pre-drilled holes with wood screws "b2".
- * Attach WD09 between WD07 and WD04 with wood screws "b2".
- * Attach both WC13 as shown.

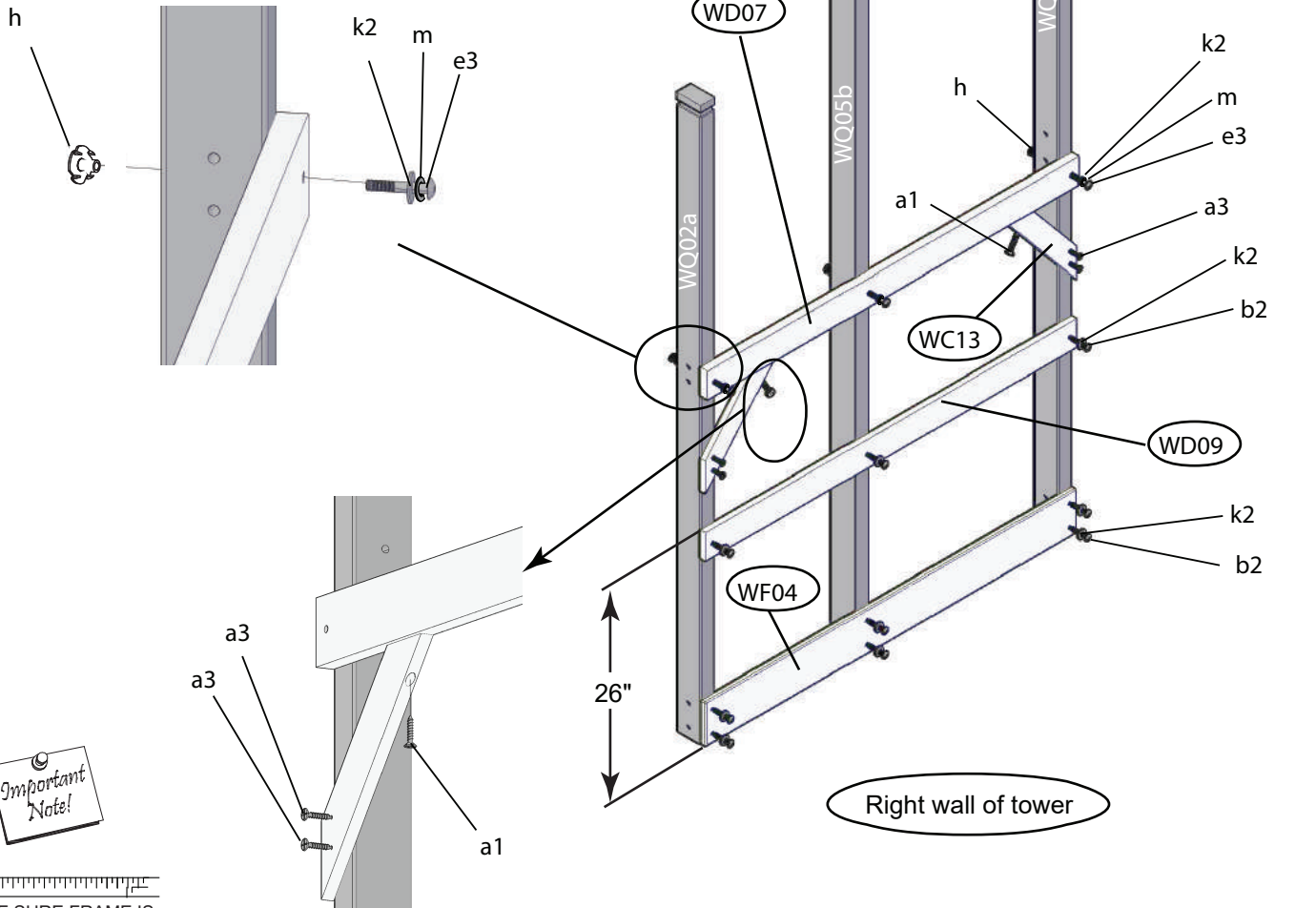

Important Note!

MAKE SURE FRAME IS SQUARE BEFORE PROCEEDING TO NEXT PHASE!

ITEMS NEEDED

- (1) WQ02a Upright-A 3×4×78 3/4
- (1) WF04 Sandbox Board-B 1×6×52 13/16
- (1) WQ05a Upright-C 3×4×89 5/16
- (1) WQ05b Upright-D 3×4×89 5/16
- (1) WD07 Floor Joist 5/4×4×52 13/16
- (1) WD09 First Floor Guardrail 1×4×52 13/16
- (2) WC13 Platform Support 1×3×15 5/16

HARDWARE NEEDED

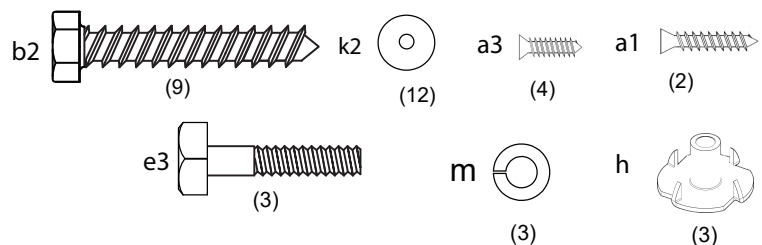

TOWER ASSEMBLY

STEP 2:

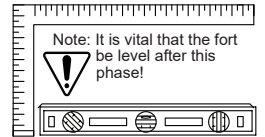

- * Insert all T-Nuts "h" into the uprights respectfully.
- * Lay out WQ06a, WQ06b and WQ02b as shown.
- * Attach WD07 into the pre-drilled holes with bolts "e3".
- * Attach WF04 into the pre-drilled holes with wood screws "b2".
- * Attach both WC13 as shown.

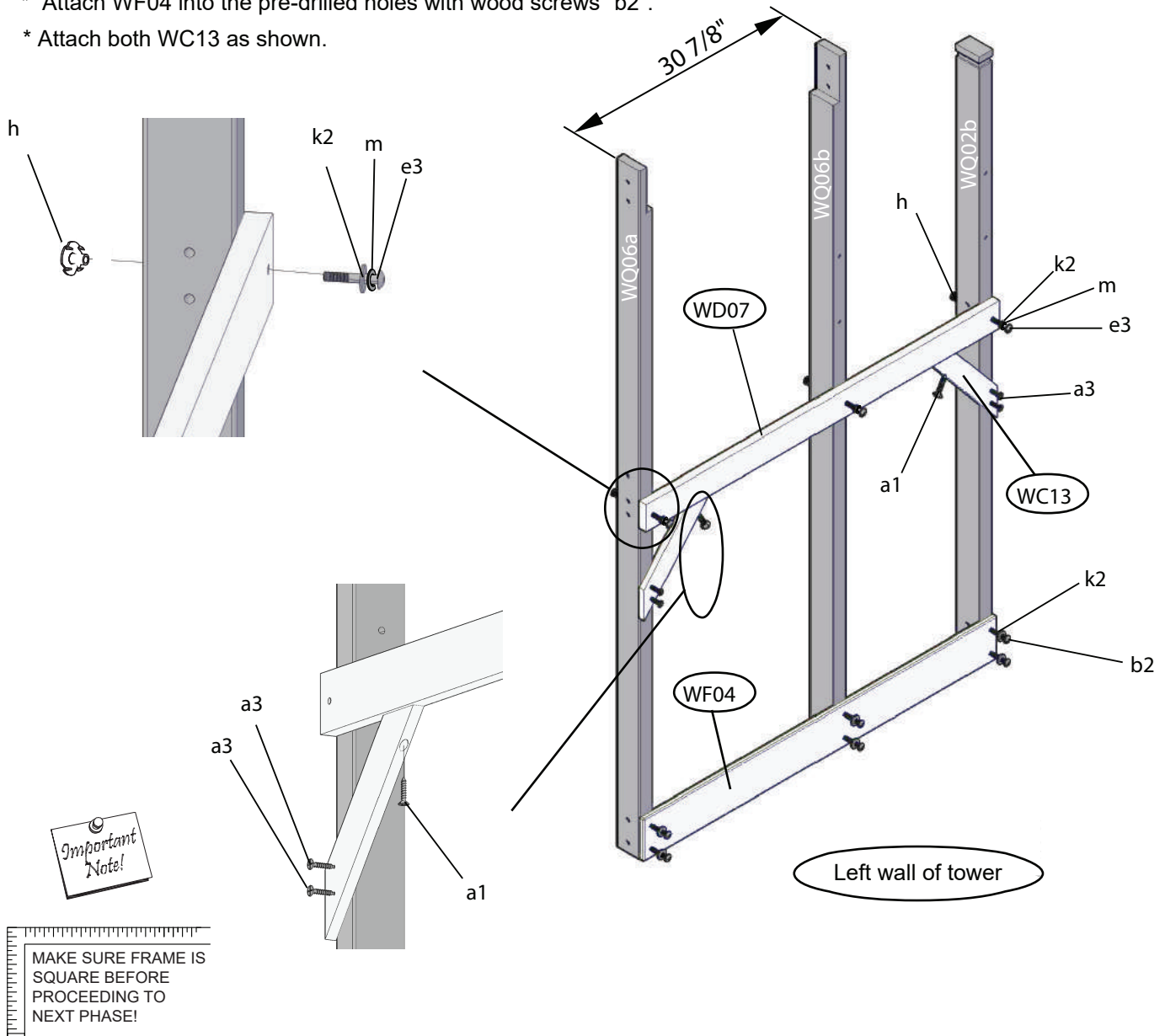

ITEMS NEEDED

- (1) WQ02b Upright-B 3×4×78 3/4
- (1) WF04 Sandbox Board-B 1×6×52 13/16
- (1) WD07 Floor Joist 5/4×4×52 13/16
- (1) WQ06a Upright-E 3×4×89
- (1) WQ06b Upright-F 3×4×89
- (2) WC13 Platform Support 1×3×15 5/16

HARDWARE NEEDED

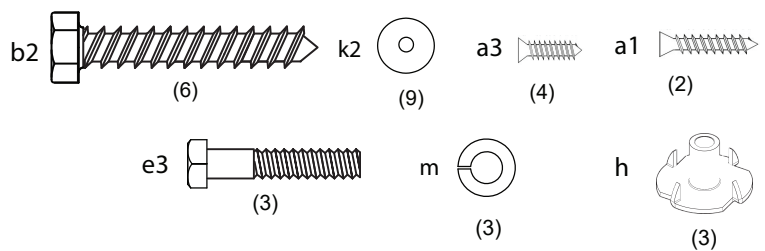

TOWER ASSEMBLY

STEP 3:

- * Insert all T-Nuts "h" into the uprights respectively.
- * Stand Right Wall from Step1 and Left Wall from Step2.
- * Attach both WF01 to form the front and back bottom of the tower with bolts "e6".
- * Attach both WD03 to form the front and back middle of the tower with bolts "e5".

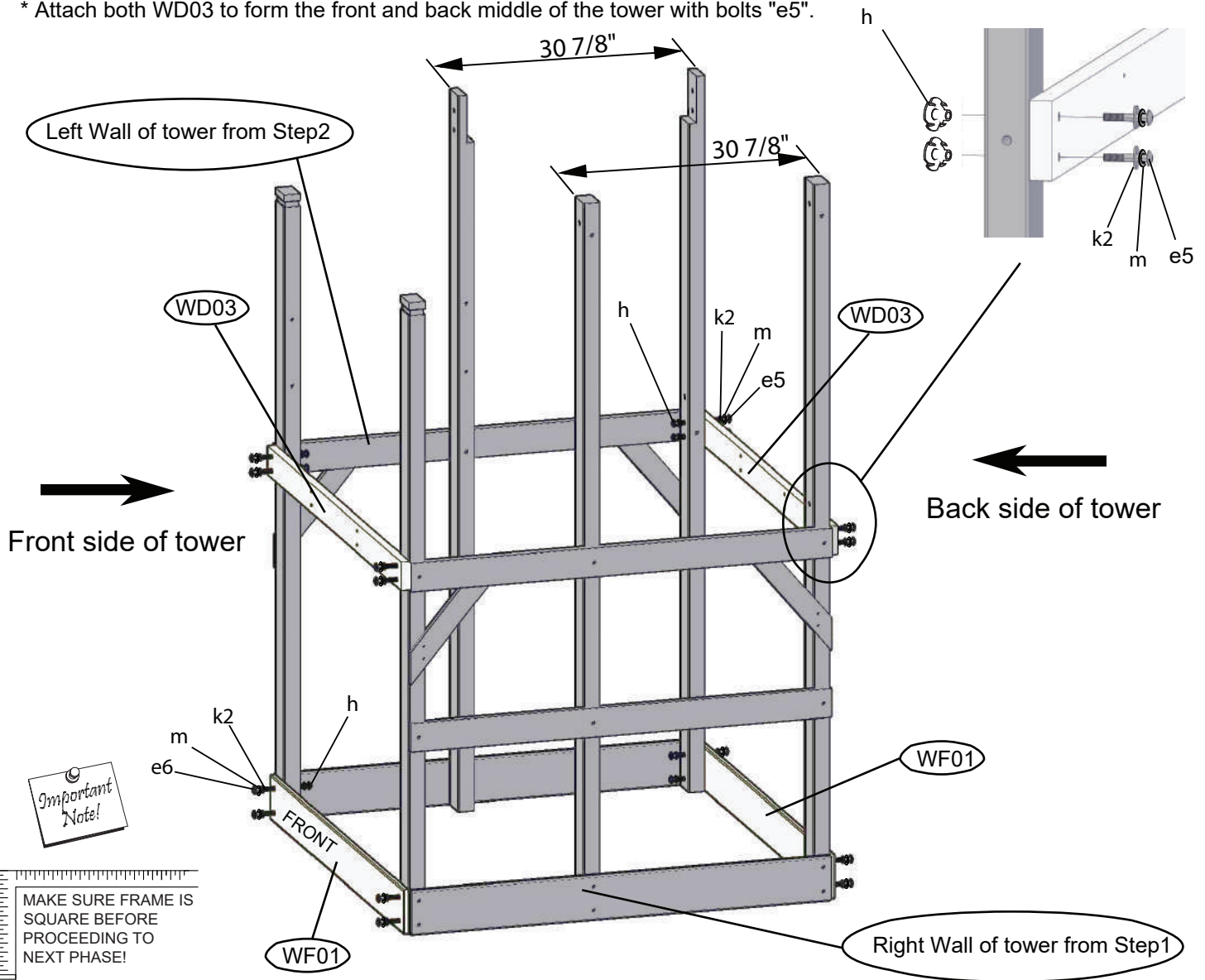
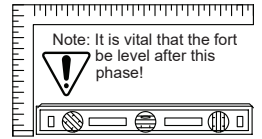

Important Note!

MAKE SURE FRAME IS SQUARE BEFORE PROCEEDING TO NEXT PHASE!

ITEMS NEEDED

- (2) WD03 End Floor Support 5/4×4×54
- (2) WF01 Sanbox board-A 1×6×54

HARDWARE NEEDED

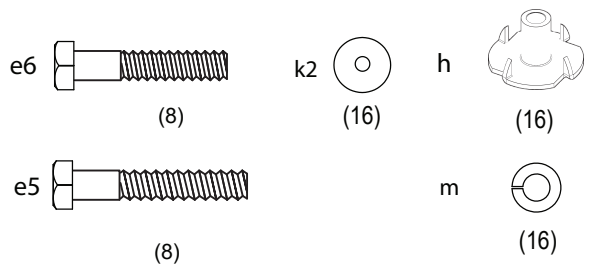

TOWER ASSEMBLY

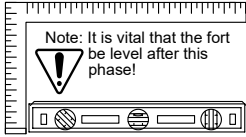

STEP 4:

- * Attach both WD08 with wood screws "a2".
- * Install four "L" brackets (M003) with wood screws "c2".

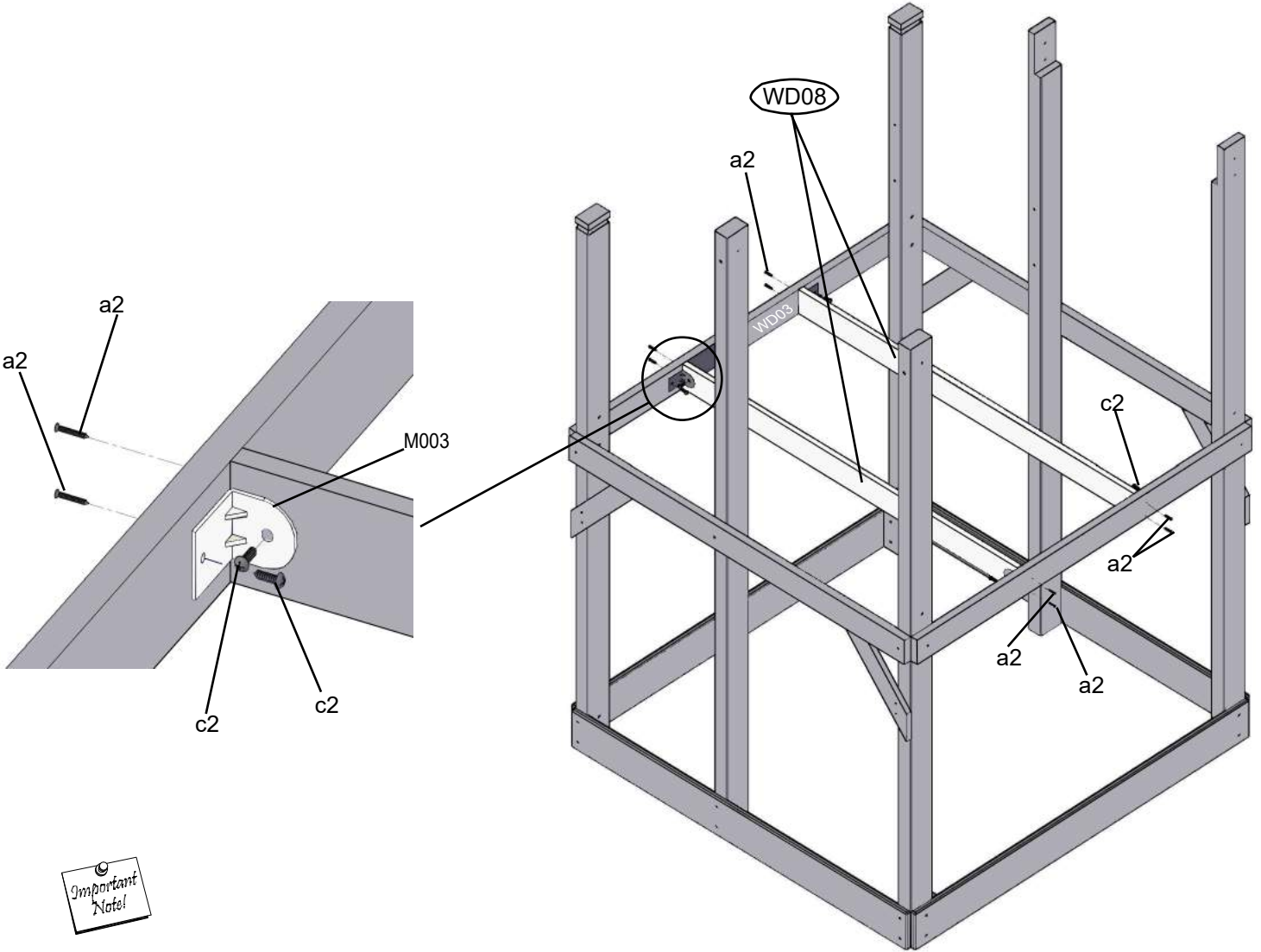

Important Note!



MAKE SURE FRAME IS SQUARE BEFORE PROCEEDING TO NEXT PHASE!

ITEMS NEEDED

(2) WD08 Floor Support 1x4x52 3/4

(4) M003 

HARDWARE NEEDED

c2  (8) a2  (8)

TOWER ASSEMBLY

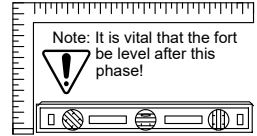

STEP 5:

- * Lay WF15a, WF15b, WF16 in its rightful place as shown.
- * Lay all eleven WF14 in between to from the tower deck.
- * Once all slats are in place, make sure all slats are flush on the left and right side of the tower.
- * Once all slats are are flush secure slats with wood screw "a3".

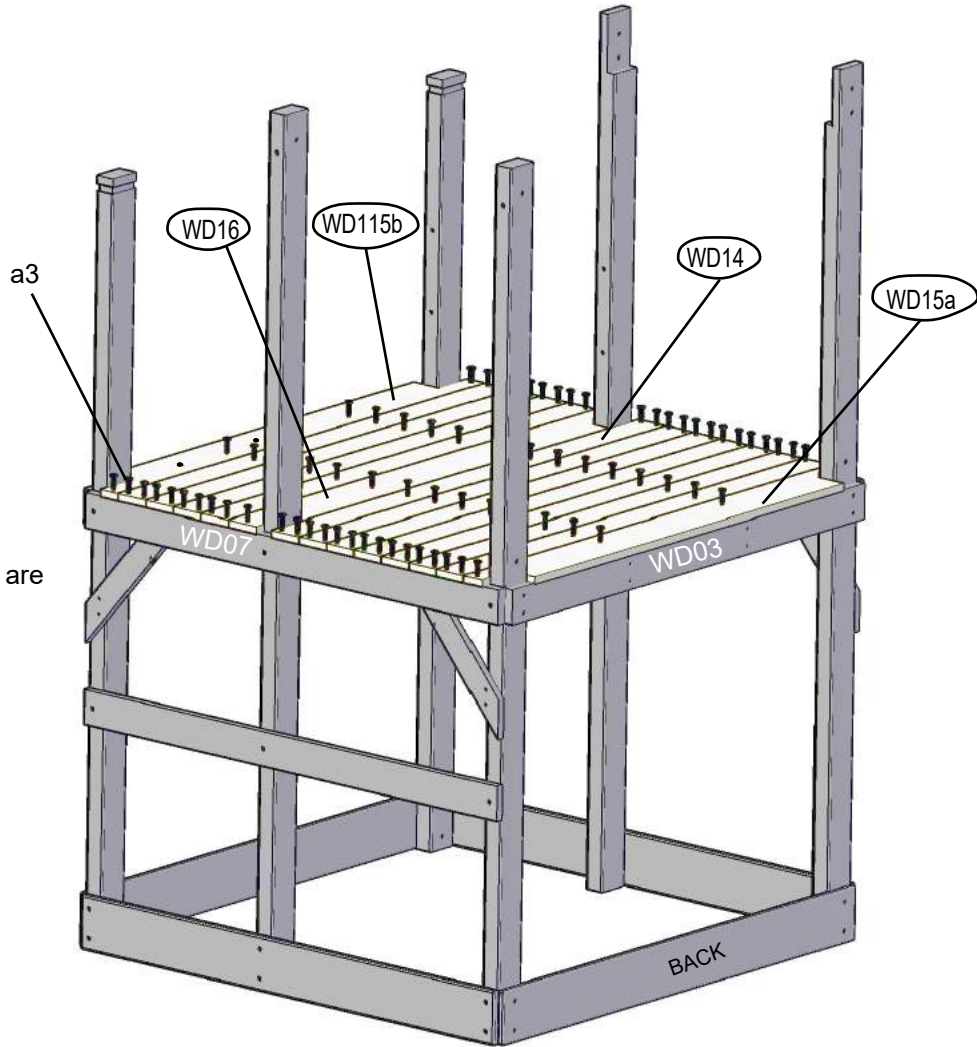

Make sure "a3" wood screws are going into the suport below.



MAKE SURE FRAME IS SQUARE BEFORE PROCEEDING TO NEXT PHASE!

ITEMS NEEDED

- (11) WF14 Floor Board-A 1×4×56 1/8
- (1) WF15a Floor Board-B 1× 4×56 1/8
- (1) WF15b Floor Board -C 1× 4×56 1/8
- (1) WF16 Floor Boardb-D 1×6×56 1/8

HARDWARE NEEDED

- a3  (78)

TOWER ASSEMBLY

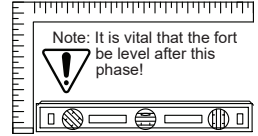

STEP 6:

- * Insert all T-Nuts "h" into the uprights respectfully.
- * Attach WD23 and WD31 to WQ02a & b with wood screw "b2".
- * Attach WF22 to WQ02a & b (See diagram below).
- * From the inside deck, attach four WD24 to the right of the arch with wood screws "a3".
- * From the inside deck, attach one WD24 to the left of the arch with wood screws "a3".

Inside view

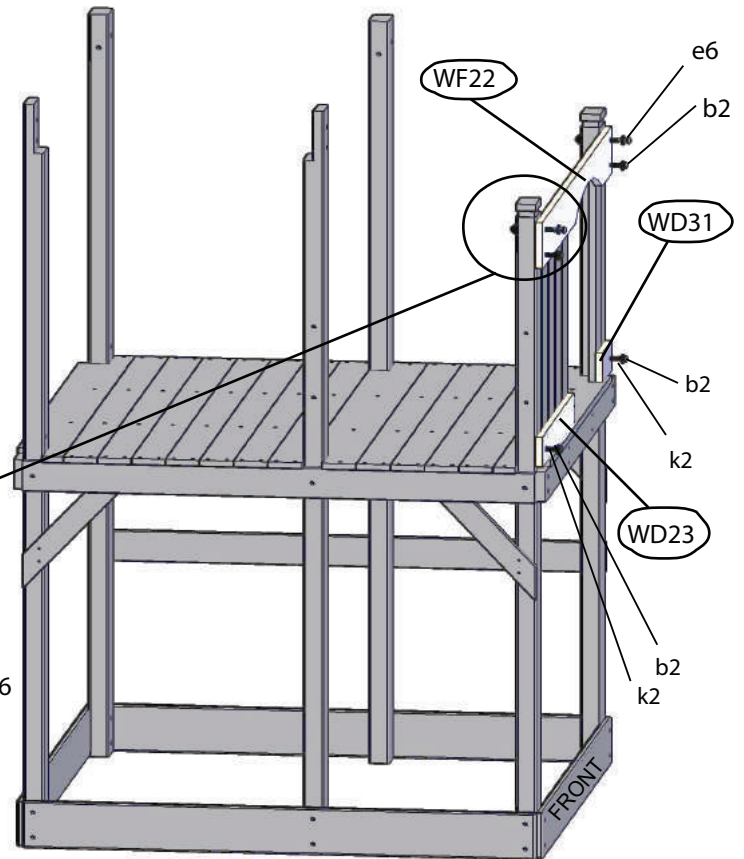
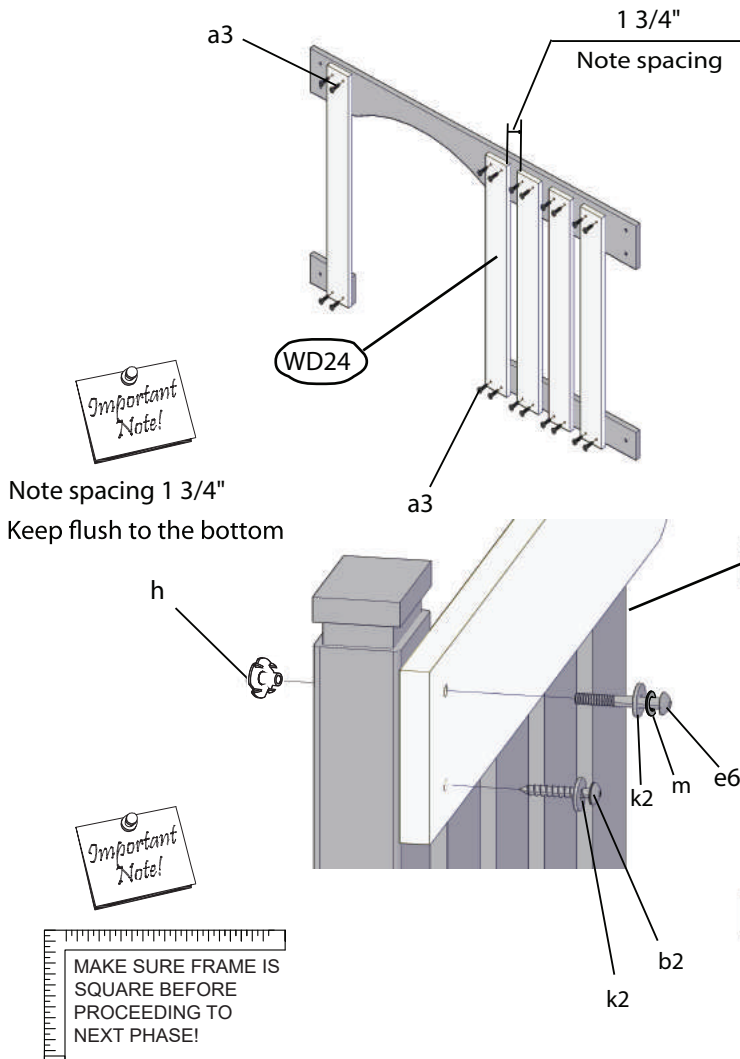

Front wall assembly

ITEMS NEEDED

- (1) WF22 Playhouse Arched Guardrail-A 1×6×54
- (1) WD23 Tower Surrounded Board 1×4×24 3/8
- (1) WD31 Tower Surrounded Board-C 1×4×6 27/32
- (5) WD24 Playhouse Wall Slat-A 1×4×27 9/16

HARDWARE NEEDED

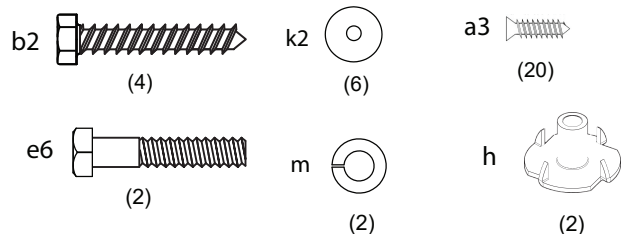

TOWER ASSEMBLY

STEP 7:

- * Attach WD33 and WF26 with wood screws "b2".
- * From the inside deck, attach WD30 to the right of the arch with wood screws "a3".
- * From the inside deck, attach seven WD24 to the right of WD30 side by side with no spaces in between with wood screws "a3".

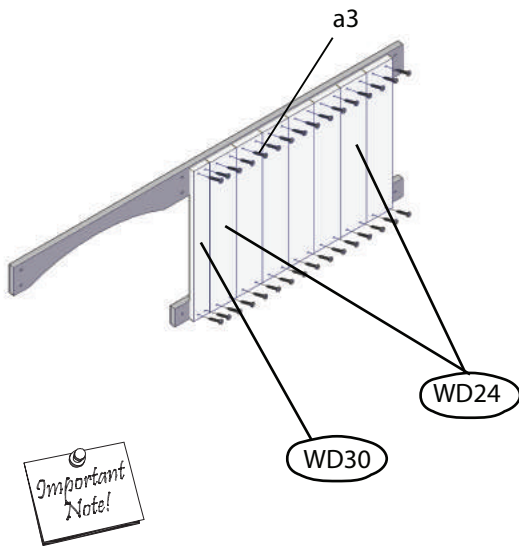

Important Note!

Keep flush to the bottom

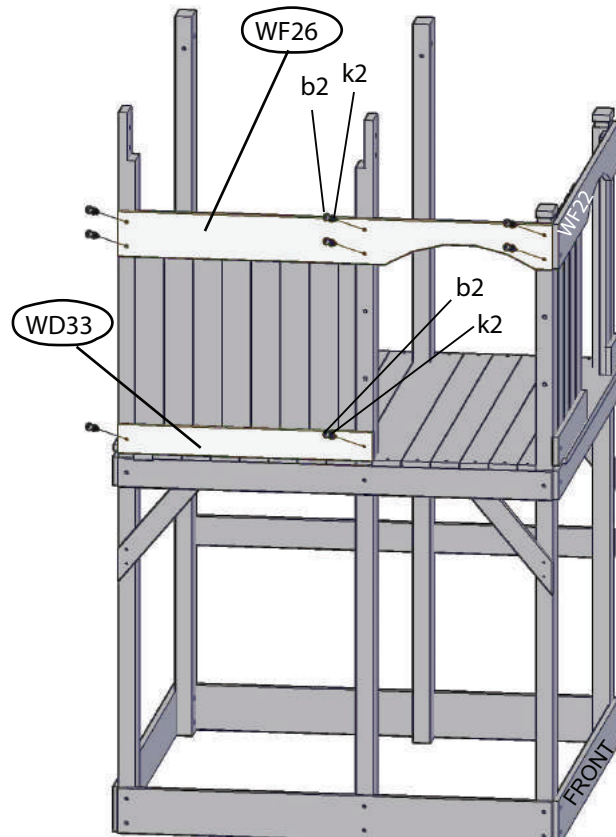

Left wall assembly

ITEMS NEEDED

- (1) WF26 Playhouse Arched Guardrail-B 1×6×52 13/16
- (1) WD33 Tower Surrounded Board-D 1×4×31
- (1) WD30 Playhouse Wall Slat-D 1×3×27 9/16
- (7) WD24 Playhouse Wall Slat-A 1×4×27 9/16

HARDWARE NEEDED



TOWER ASSEMBLY

STEP 8:

- * Insert T-Nuts "h" into the uprights respectfully.
- * Attach the WD23 and WD31 to the uprights with bolts "e6".
- * Attach WF22 to the uprights with wood screws "b2".
- * From the inside deck, attach both WD25b, one on each side of the arch with wood screws "a3".
- * From the inside deck, attach five WD24 to the right of the WD25b, also on the right of the arch.
(There should be no spaces).

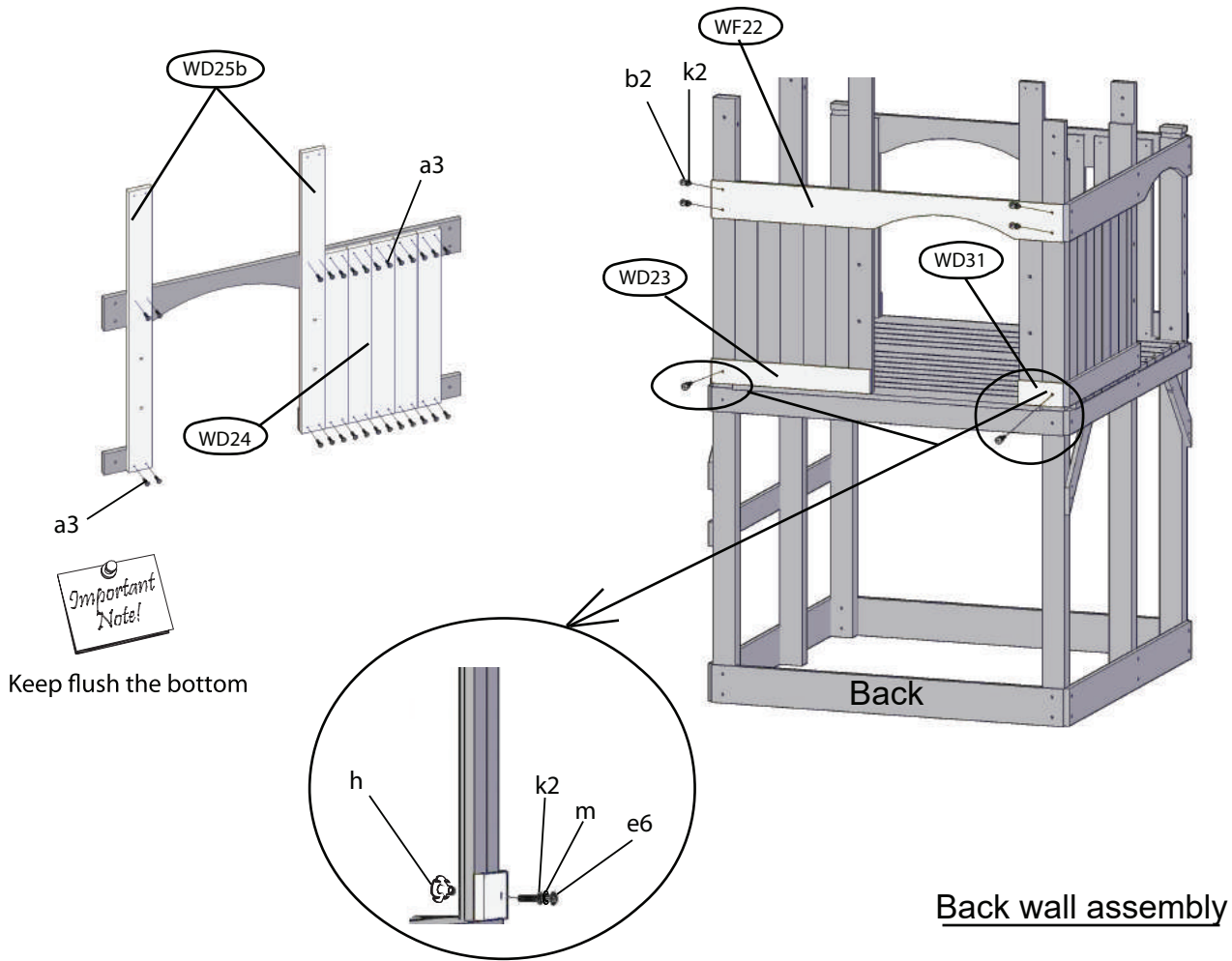

ITEMS NEEDED

- (1) WF22 Playhouse Arched Guardrail-A 1×6×54
- (1) WD23 Tower Surrounded Board 1×4×24 3/8
- (1) WD31 Tower Surrounded Board-C 1×4×6 27/32
- (5) WD24 Playhouse Wall Slat-A 1×4×27 9/16
- (2) WD25b Playhouse Wall Slat-C 1×4×46 3/4

HARDWARE NEEDED

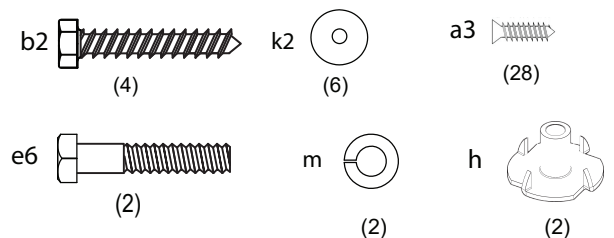

TOWER ASSEMBLY

STEP 9:

- * Attach both WD23 with wood screws "b2".
- * From the inside of the playhouse, attach five WD24 followed by one WD25a to the right (There should be no spaces).

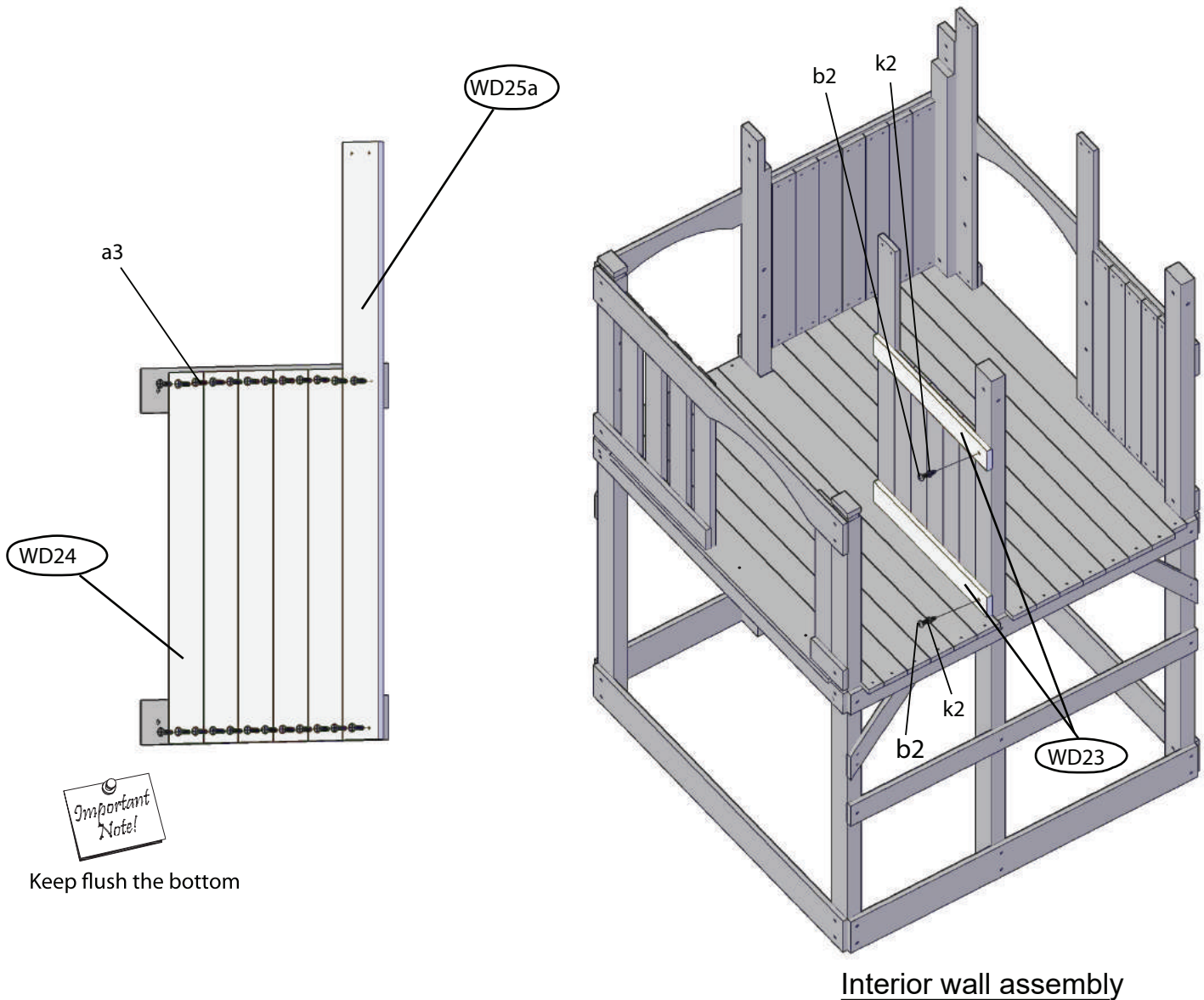

ITEMS NEEDED

- (2) WD23 Tower Surrounded Board 1×4×24 3/8
- (5) WD24 Playhouse Wall Slat-A 1×4×27 9/16
- (1) WD25a Playhouse Wall Slat-B 1×4×46 3/4

HARDWARE NEEDED

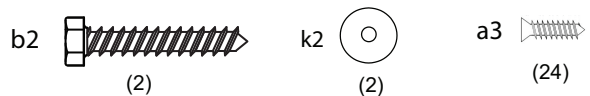

TOWER ASSEMBLY

STEP 10 :

- * Attach WD31 with wood screws "b2" from the front .
- * From the inside of the play house, attach WD25c with wood screws "a3".
- * Install six L brackets "M003" as shown.

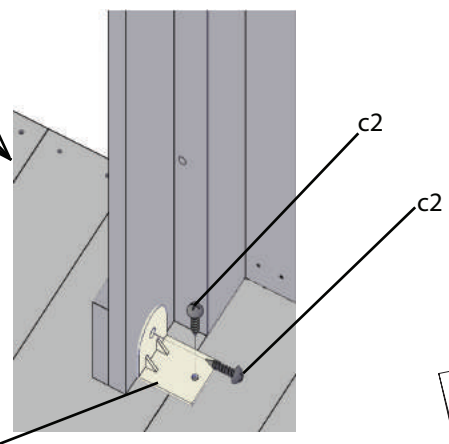
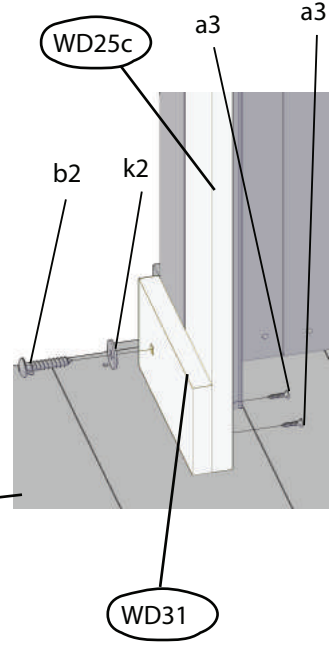
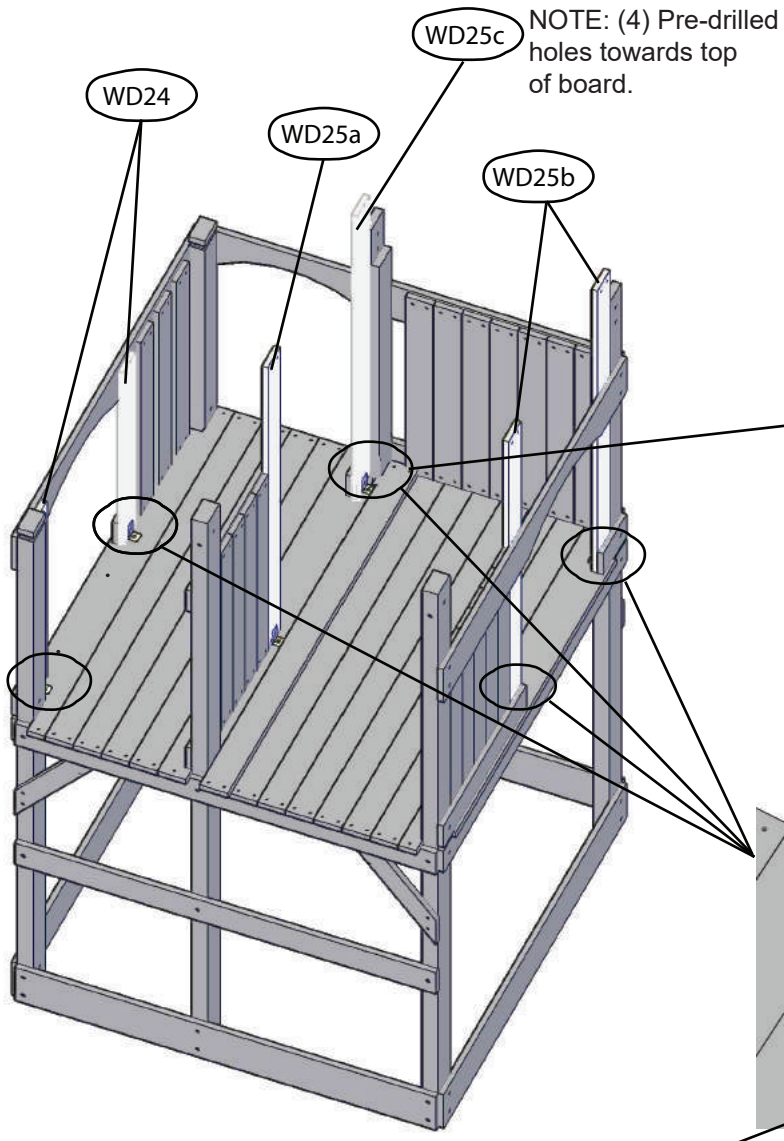

Important Note!

Putting screws in too close to the edge of the floor slats may cause it to split

ITEMS NEEDED

- (1) WD25c Playhouse Wall Slat-E 1×4×46 3/4
- (1) WD31 Tower Surrounded Board-C 1×4×6 27/32
- (6) M003 

HARDWARE NEEDED

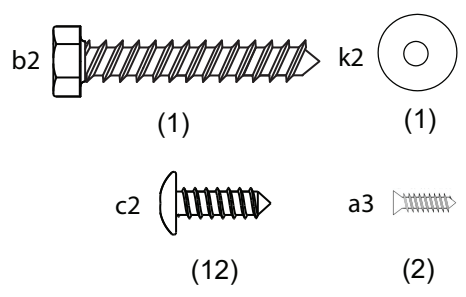

TOWER ASSEMBLY

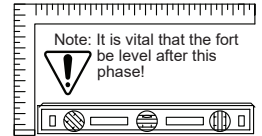

STEP 11 :

- * From the inside of the playhouse, place both WQ32 into its place so you can see the correct orientation.
- * Insert two T-Nuts "h" into both WQ32.
- * Attach both WQ32 extensions into uprights (WQ06a & WQ06b) with bolt "e8".
- * From the inside of the playhouse, insert the two remaining T-Nuts "h" as shown.
- * Attach both WF18 with bolts "e6" and wood screws "b2" from the front and back of the playhouse.
- * Attach WF19 with wood screws "b2".
- * Attach WD20 with wood screws "b2" about 3" front the top.

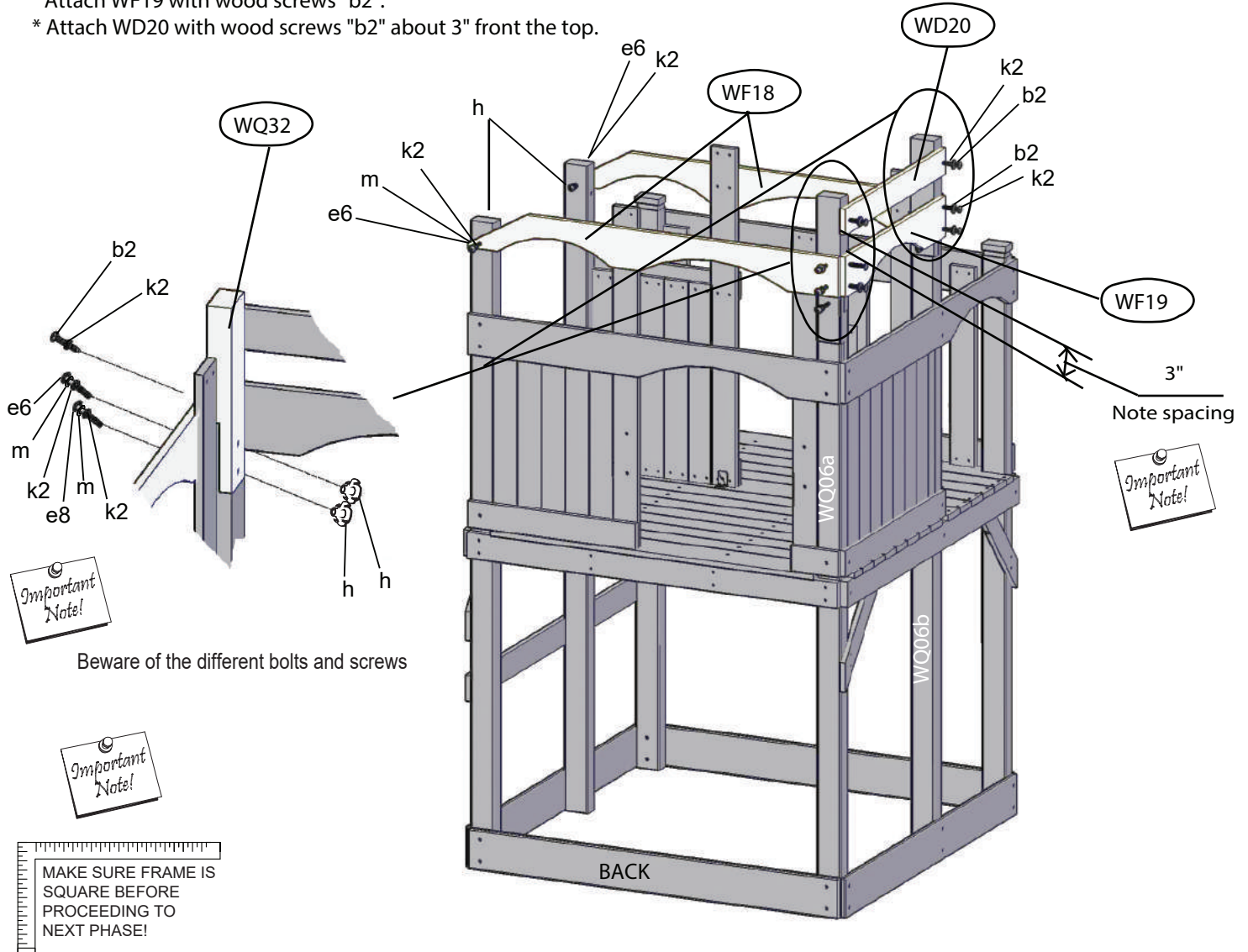

Important Note!

Beware of the different bolts and screws

Important Note!

MAKE SURE FRAME IS SQUARE BEFORE PROCEEDING TO NEXT PHASE!

ITEMS NEEDED

- (2) WF18 Top Double Arch Board 1×6×54
- (1) WF19 Top Arch Board 1×6×31
- (1) WD20 Top Brace 1×4×31
- (2) WQ32 Upright-G 3×4×15 29/32

HARDWARE NEEDED

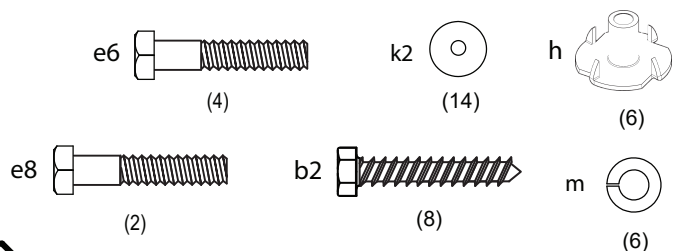

TOWER ASSEMBLY

STEP 12 :

* Attach four WF10 with wood screws "b2".

* Attach both WF11 with wood screws "a3".

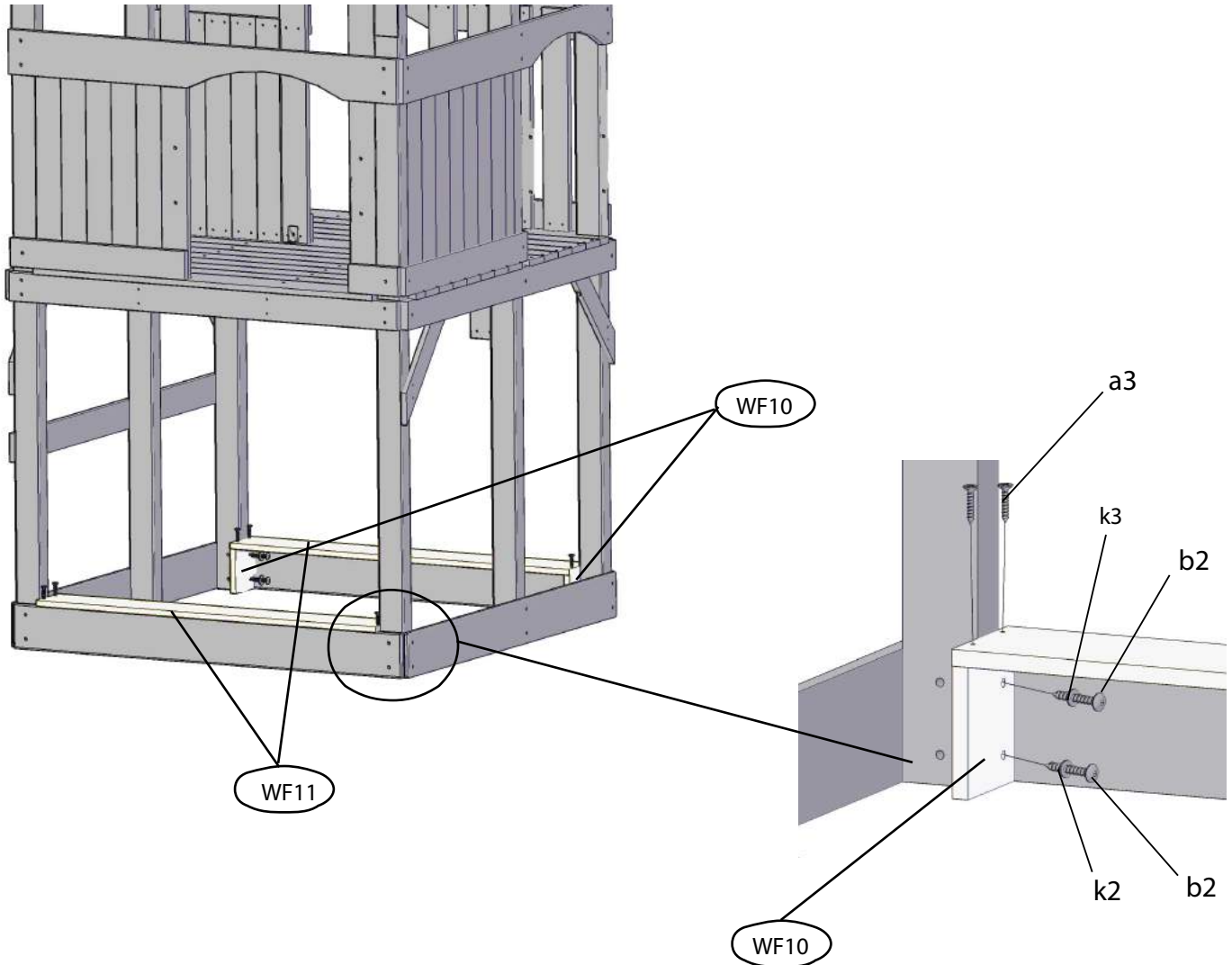

ITEMS NEEDED

- (4) WF10 Sandbox Seat Support 1×6×4 1/2
- (2) WF11 Sandbox Seat 1×6×47 1/4

HARDWARE NEEDED

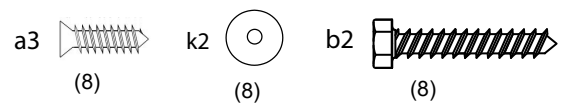

TOWER ASSEMBLY

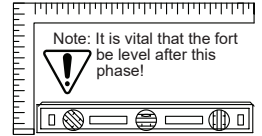

STEP 13 :

- * Insert four T-nuts "h" into the backside of WF29 for use in Step22.
- * Attach WF29 with bolts "e5" and wood screws "b2".
- * Attach WF27 and WD09 with wood screws "b2".
- * From the inside of the playhouse, attach seven WC17b and one WC17a with wood screws "a3"
- * From the inside of the playhouse, attach three WD24 with wood screws "a3".

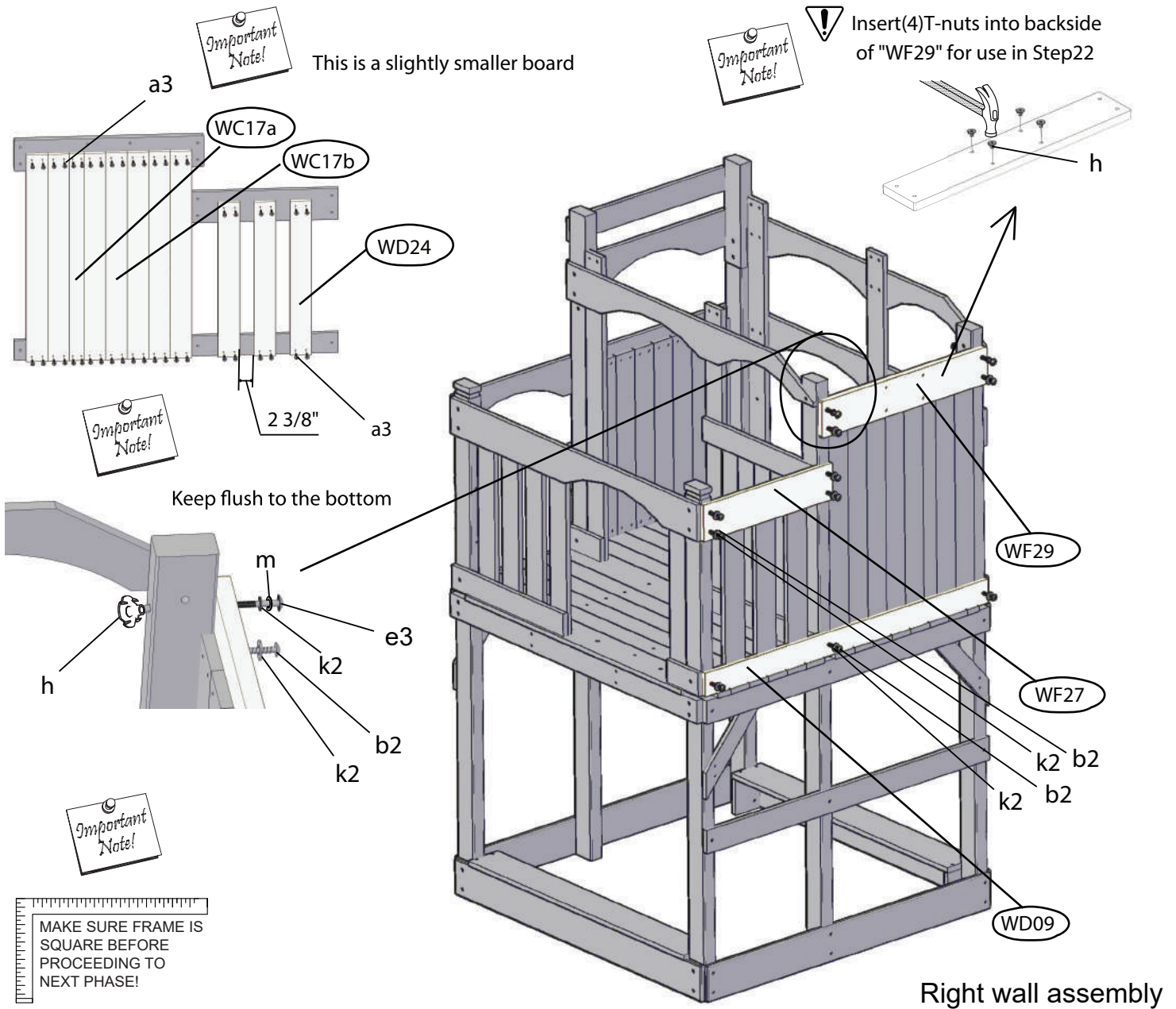

ITEMS NEEDED

- (1) WF27 Gazebo Guardrail 1×6×23 29/32
- (1) WF29 Swing Attached Board 5/4×6×31
- (1) WD09 First Floor Guardrail 1×4×52 13/16
- (3) WD24 Playhouse Wall Slat-A 1×4×27 9/16
- (1) WC17a Wall Slat-A 1×3×37
- (7) WC17b Wall Slat-B 1×4×37

HARDWARE NEEDED

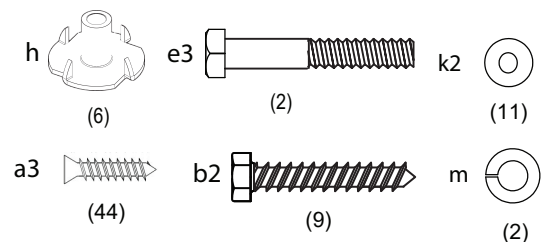

ROCKWALL ASSEMBLY

STEP 14 :

- * Create the rockwall by attaching two WD38 with seventeen rockwall boards. Note the orientation of the holes.
- * Suggestion: Line up all the rockwall boards and make sure, they are all flush before securing with wood screws "a3".
- * From the back of assembled rock wall insert T-Nuts.
- * Install the climbing rocks (See detail diagram below).

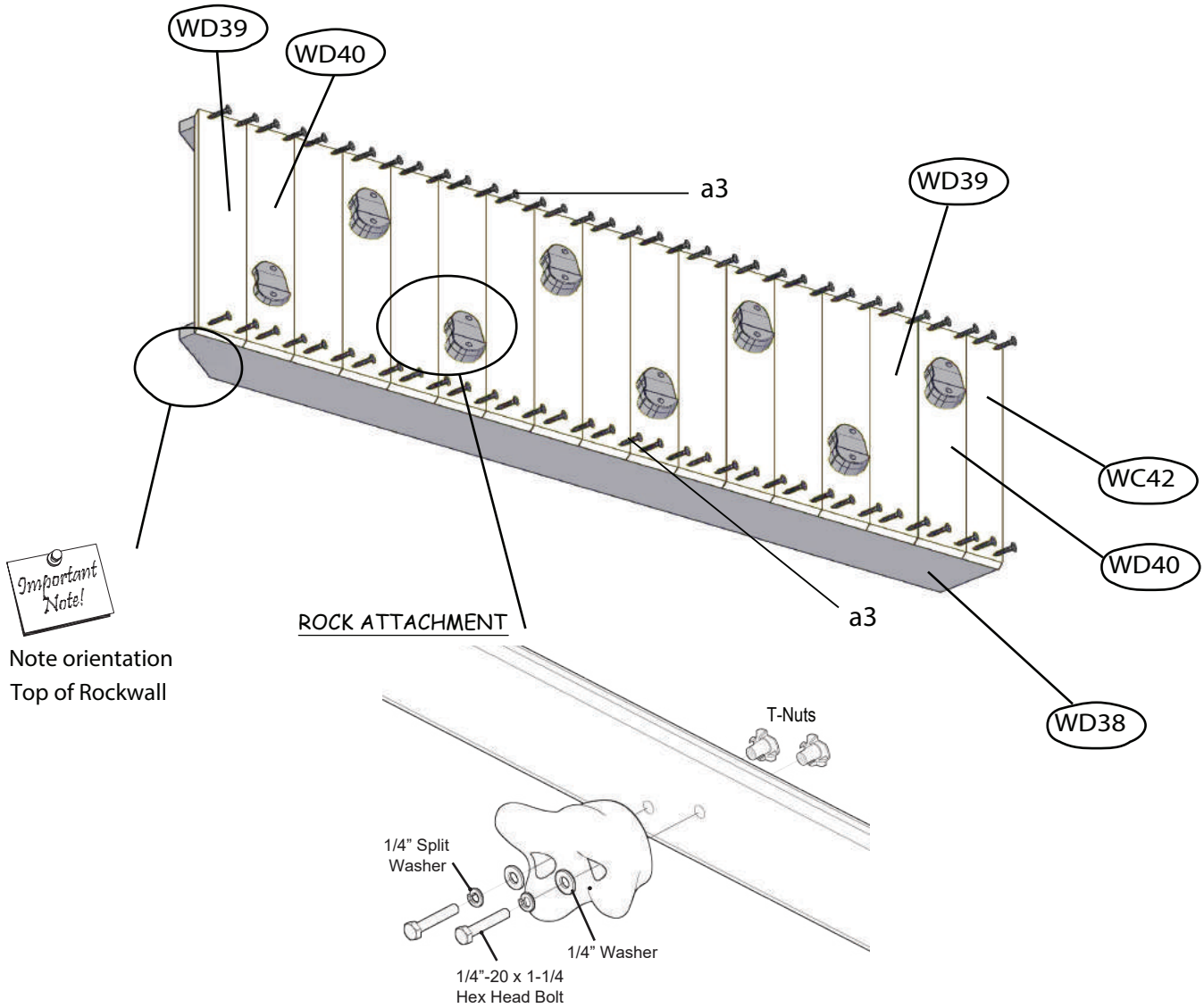

ITEMS NEEDED

- (2) WD38 Rockwall Rail 5/4x4x59 3/4
- (8) WD39 Rockwall Board-A 1x4x21
- (8) WD40 Rockwall Board-B 1x4x21
- (1) WC42 Rockwall Board-C 1x3x21



HARDWARE NEEDED

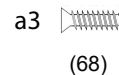

PLEASE REFER TO
ACCESSORY PLAN FOR
INSTALLATION INSTRUCTIONS
AND HARDWARE

ROCKWALL ASSEMBLY

STEP 15 :

- * Attach both L brackets "M003" to Rockwall (See detailed diagram below).
- * Attach Rockwall with installed L brackets "M003" to the playset's back wall.

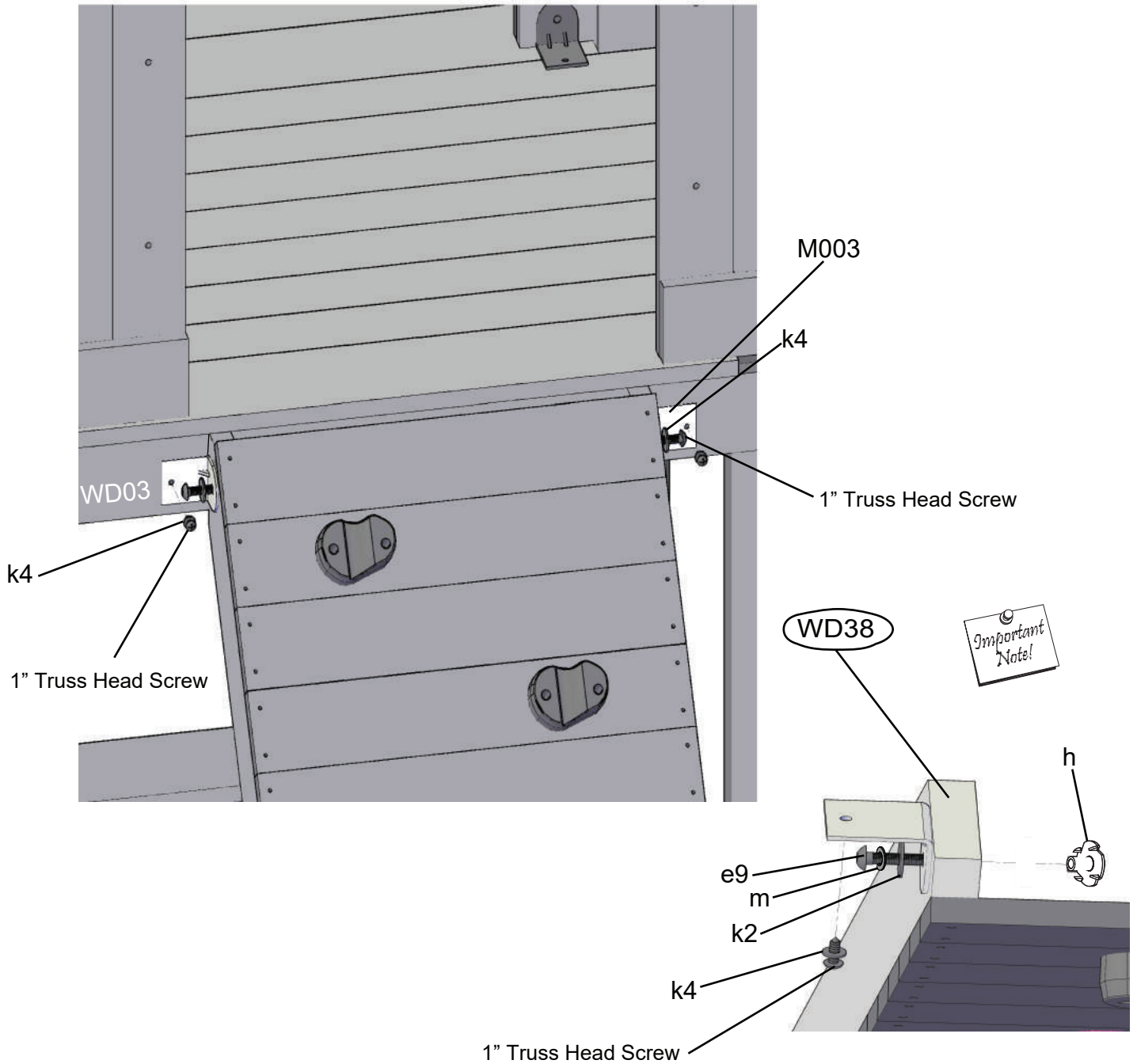

ITEMS NEEDED

(2) M003



HARDWARE NEEDED

1" Truss Head Screw

(2)



k4



(2)

h



(2)

e9



(2)

k2



(2)

m



(2)

LADDER ASSEMBLY

STEP 16 :

- * Create the ladder by attaching four WD36 in between WD34 and WD35. They should fit comfortably inside the notches and securing with wood screws "a3".
- * Attach WD37 to ladder with wood screws "a3".
- * Attach ladder to the playset's left wall using both L bracket "M003" and 1" Truss Head Screws.

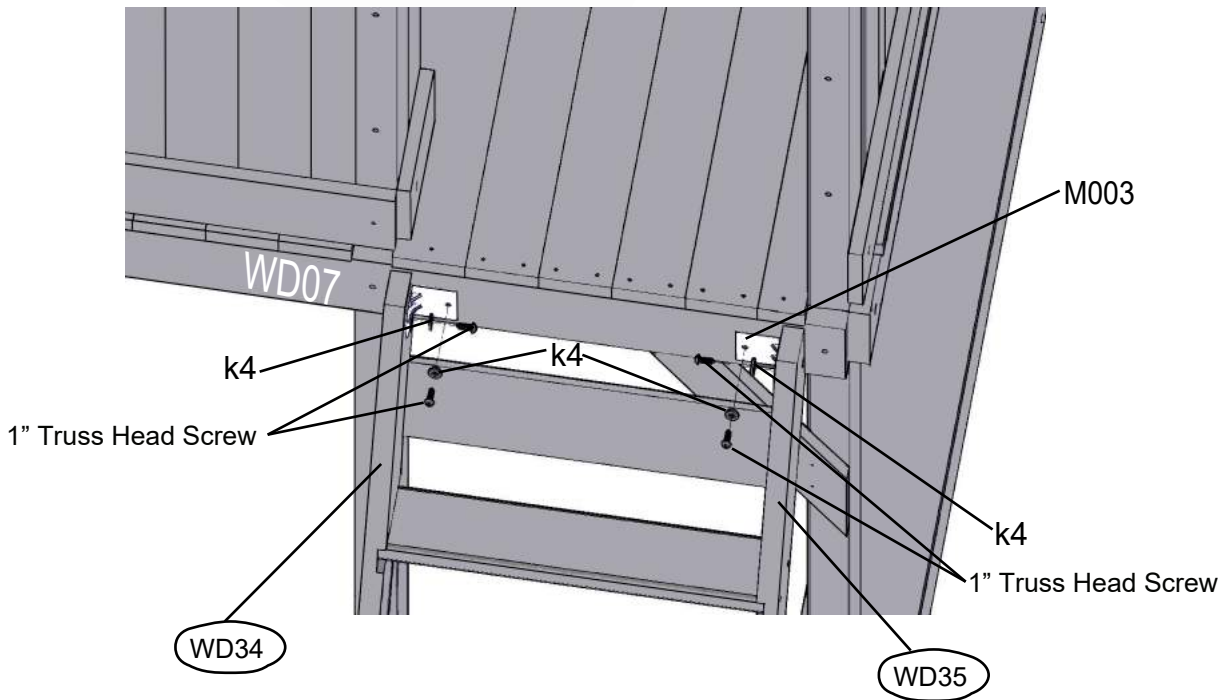
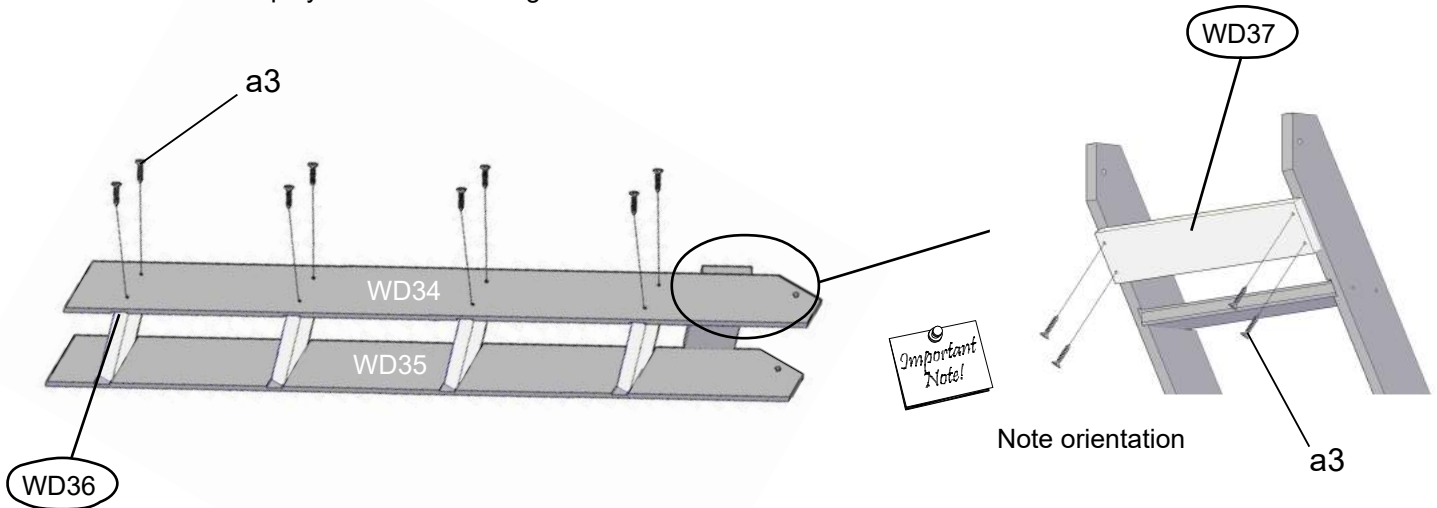

ITEMS NEEDED

- (1) WD34 Ladder Rail(Left) 5/4×4×54 3/8
- (1) WD35 Ladder Rail(Right) 5/4×4×54 3/8
- (4) WD36 Ladder Step 1×6×23 29/32
- (1) WD37 Ladder Block 1×4×20

(2) M003



HARDWARE NEEDED

a3  (20)

k4  (4)

1" Truss Head Screw

(4) 

ROOF ASSEMBLY

STEP 17 :

- * Create the short side of the roof by laying out one WF55 and four WF54 with two WD44 boards, securing with wood screws "a3".
- * Flip over assembly and attach WB52 with wood screws "a4".
- * Create the long side of the roof by laying out one WF55 and eight WF54 with two WD43 boards, securing with wood screws "a3".
- * Flip over assembly and attach WB53 with wood screws "a4".
- * Create a peak using both the short and long roofs, and attach WH51 under the roof of the assembly, securing with wood screws "a3" underneath, sides and on top, as shown.

Important Note!

Note orientation of WF55

- * Make sure all slats are flush before securing with wood screws.

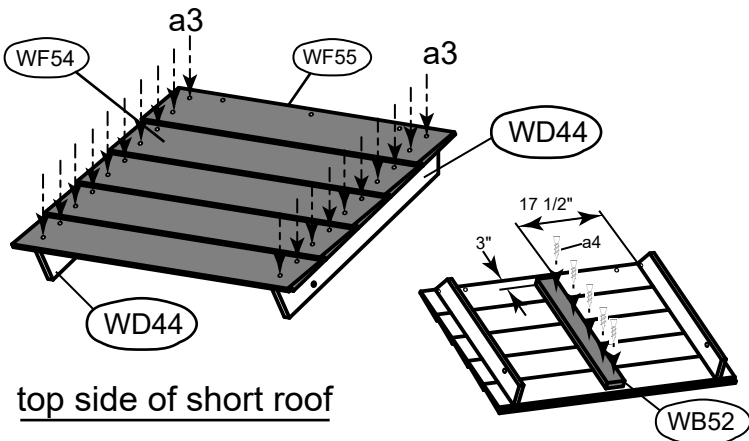

top side of short roof

under side of short roof

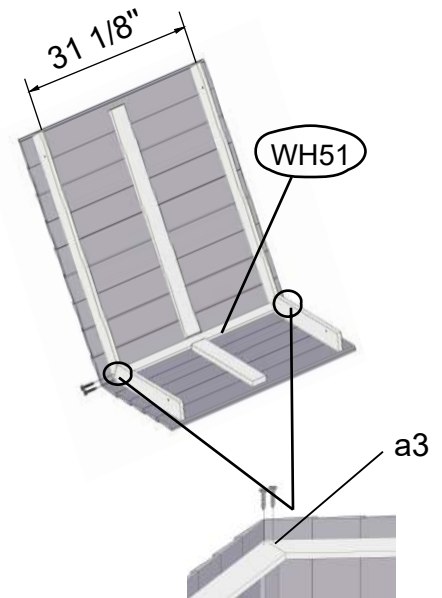

under side of roof

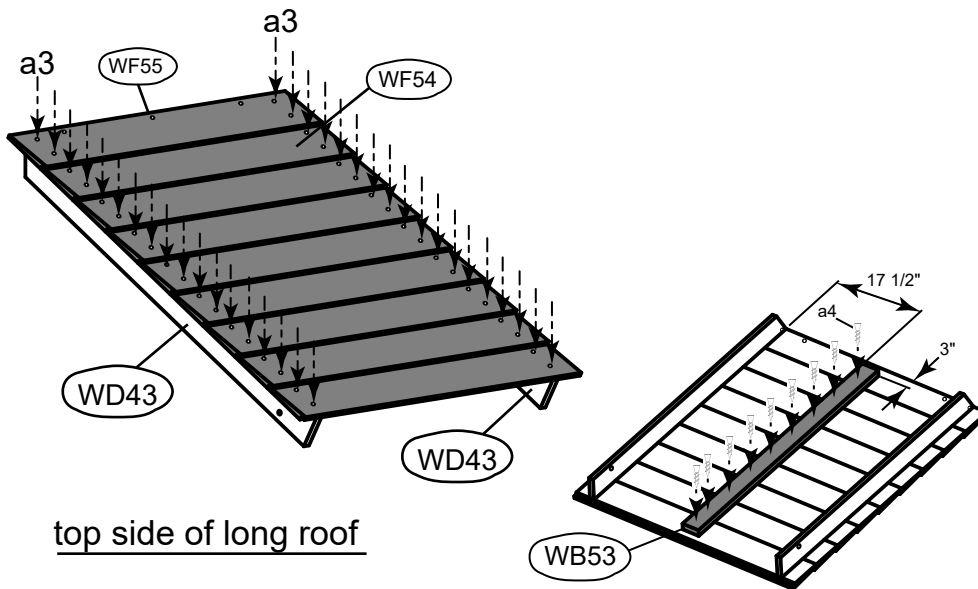

top side of long roof

under side of long roof

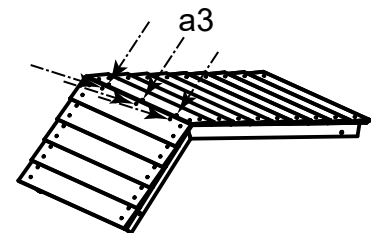



top side of roof

ITEMS NEEDED

- (2) WD43 Sunburst Frame-A 1×4×45
- (2) WD44 Sunburst Frame-B 1×4×25
- (1) WH51 Roof Beam-A 2×2×31
- (1) WB52 Roof Beam-B 1×2×19 7/8
- (1) WB53 Roof Beam-C 1×2×40 15/16
- (12) WF54 Roof Board-A 1×6×36 5/16
- (2) WF55 Roof Board-B 1×6×36 5/16

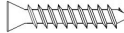
HARDWARE NEEDED

a3 
(66)

a4 
(14)

ROOF ASSEMBLY

STEP 18 :

- * Create one sunburst for the front and one for the back, with wood screws "a4" (See diagrams below).
- * Secure both sunburts to the roof from the inside with wood screws "a4".
- * From the inside, secure one WC46 to long side of each sunburst with wood screws "a4".

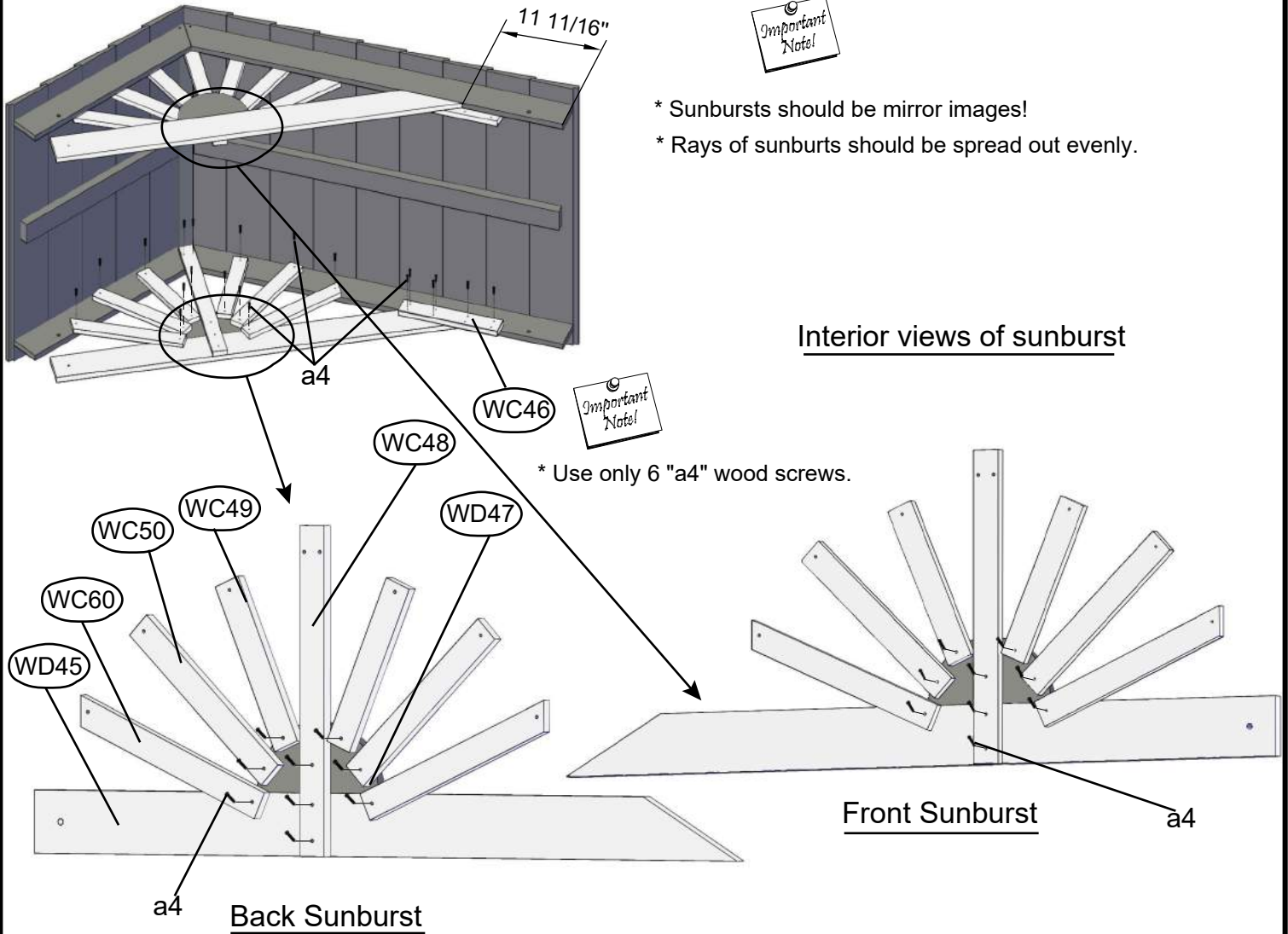

ITEMS NEEDED

- (2) WD45 Sunburst Frame-C 1×4×45 7/16
- (2) WC46 Roof Brace Fixed 1×3×11 7/16
- (2) WD47 Sunburst DecoBoard 1×4×4 7/8
- (2) WC48 Sunburst Trim-A 1×2×18 10/32
- (4) WC49 Sunburst Trim-B 1×3×9 27/32
- (4) WC50 Sunburst Trim-C 1×3×11 13/16
- (4) WC60 Sunburst Trim-D 1×3×13

HARDWARE NEEDED

- a4 
- (46)

ROOF ASSEMBLY

STEP 19 :

- * Mount the roof to the playhouse.
- * Secure WD25a, WD26b and WD25c with wood screws "a3".
- * Secure WC46 with wood screws "a4".

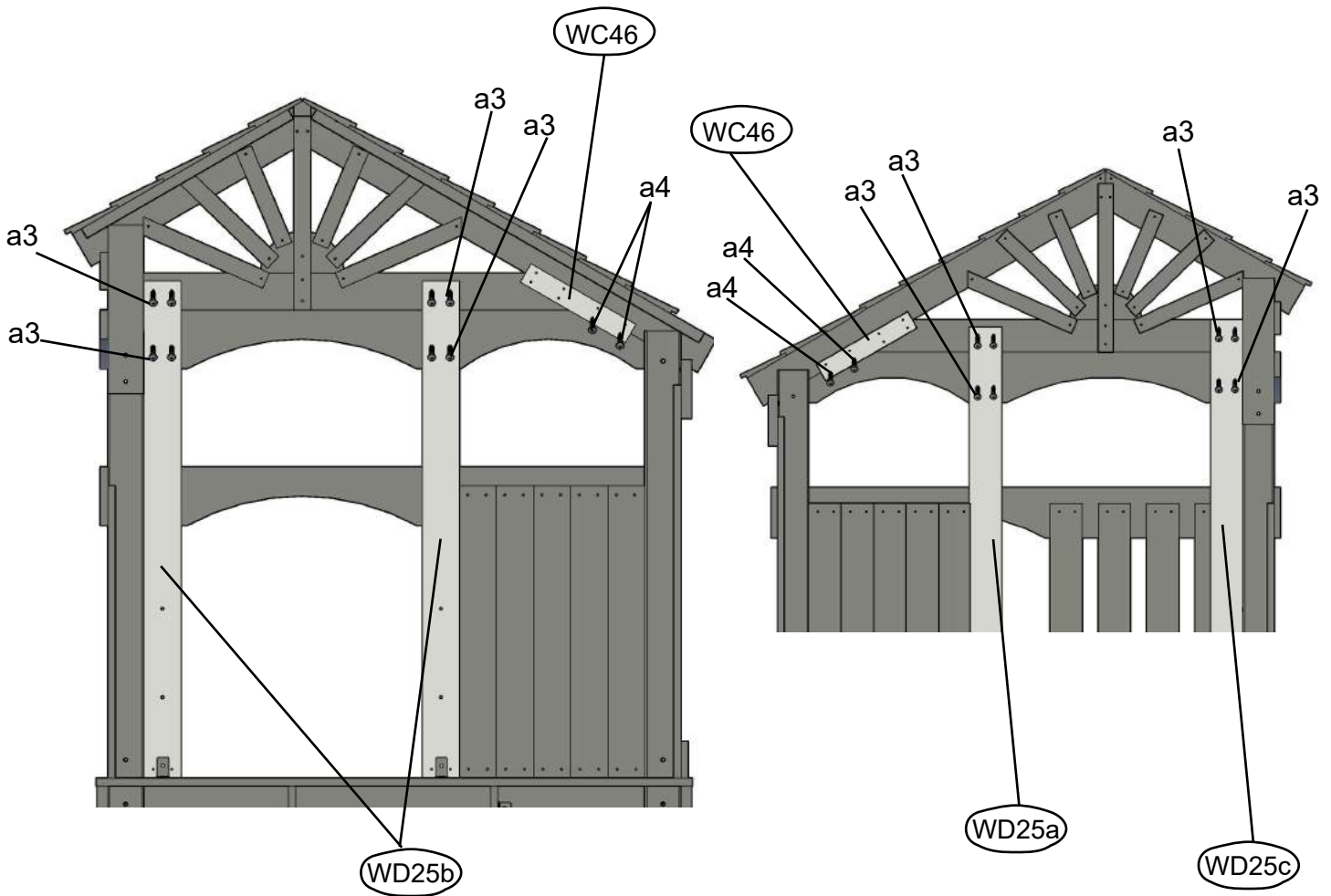

Inside view of back

Inside view of front



The shorter roof side gets mounted to the taller post.
 The longer roof side gets mounted to the shorter post.

HARDWARE NEEDED

- a3 (16)
- a4 (4)

ROOF ASSEMBLY

STEP 20 :

* Secure the roof with wood screw "b2", three time in the front and three times in the back.
NOTE: To prevent wood splitting, pre-drill all locations where "b2" screws are used.

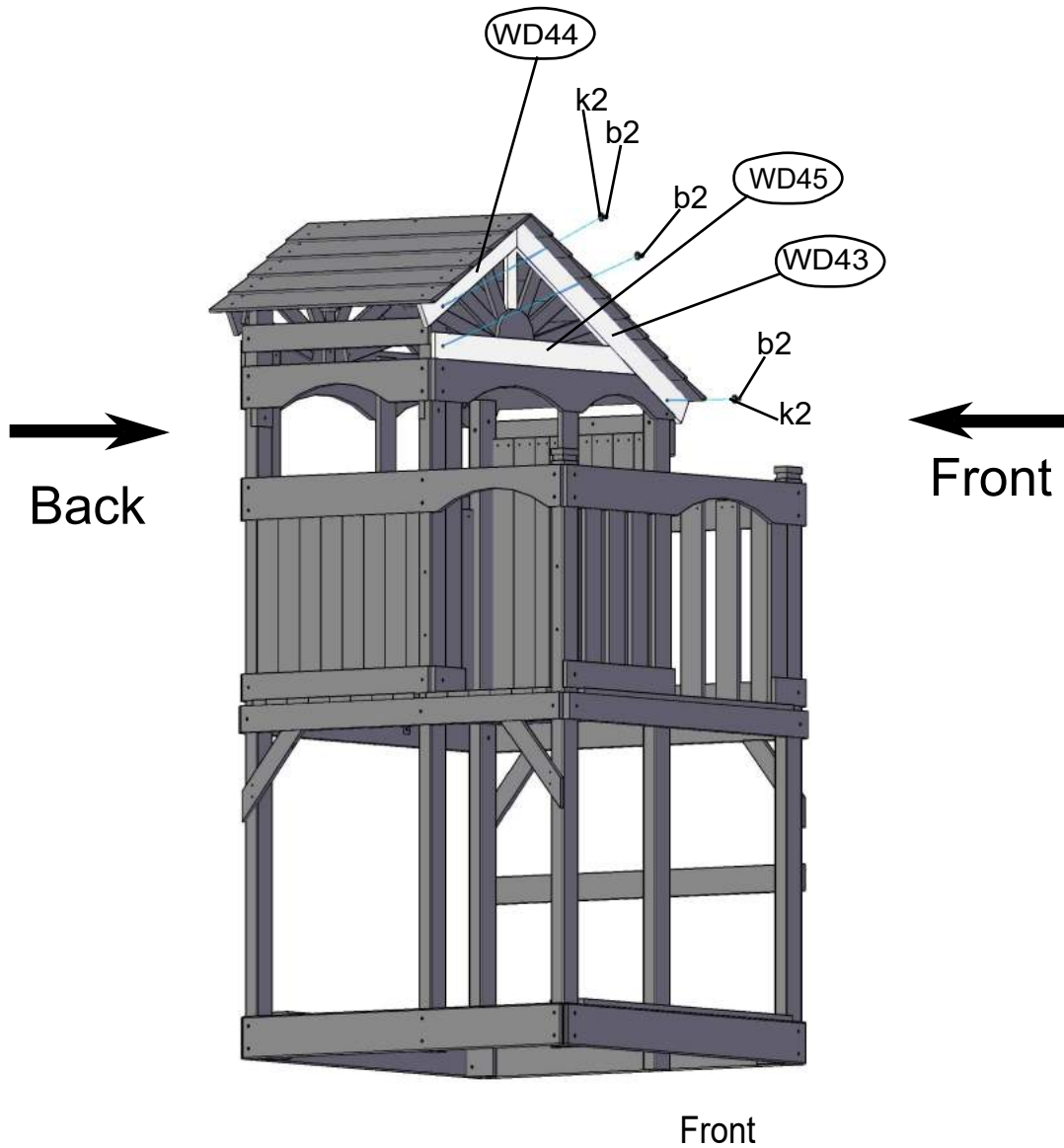

HARDWARE NEEDED

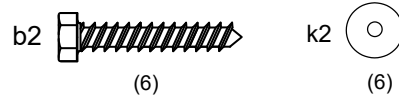

SAFETY HANDLE ATTACHMENT

STEP 21 :

- * Attach side wall's safety handle with BP 007 (wood screws) accessory plan.
- * Attach front wall's safety handle with BP 007T (T-nuts) accessory plan.

PLEASE REFER TO ACCESSORY PLAN **BP 007** (*Wood Screws*) FOR INSTALLATION INSTRUCTIONS AND HARDWARE.

WD25b

PLEASE REFER TO ACCESSORY PLAN **BP 007T** (*T-Nuts*) FOR INSTALLATION INSTRUCTIONS AND HARDWARE.



WQ02b

WQ06b

ITEMS NEEDED (2 PAIR) SAFETY HANDLE

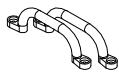

BP 007T-Y
w/ T-Nuts

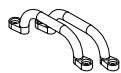

BP 007-Y
w/ Wood Screws

SWING BEAM ASSEMBLY

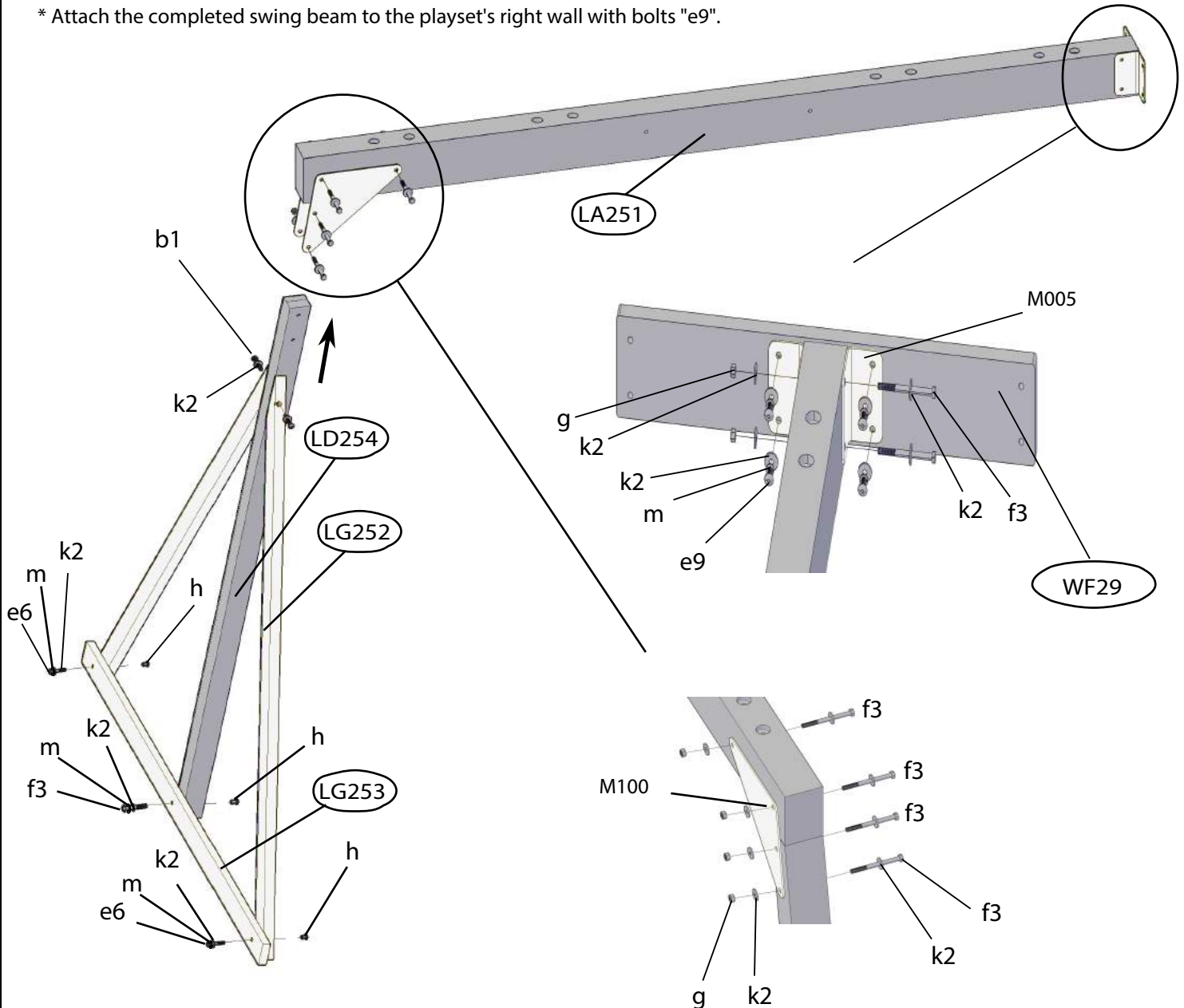

STEP 22 :

- * Prepare swing beam WZ59 by mounting two triangle plates "M100" and two angle brackets "M005" with bolts "f3".
- * Insert T-Nuts "h" into both WQ56 and WU58.
- * Create swing beam leg with both WQ56, WQ57 and WU58 with bolts "e4", "e7" and wood screws "b1".
- * Attach the swing beam WZ59 to the prepared swing beam leg.
- * Attach the completed swing beam to the playset's right wall with bolts "e9".



ITEMS NEEDED

- (1) LA251 swing beam 4x6x89 1/2
- (2) LG252 swing beam leg-A 2x4x82 1/2
- (1) LD254 swing beam leg-B 3x4x83
- (1) LG253 swing beam ground support 2x4x89

- (2) M005 
- (2) M100 

HARDWARE NEEDED

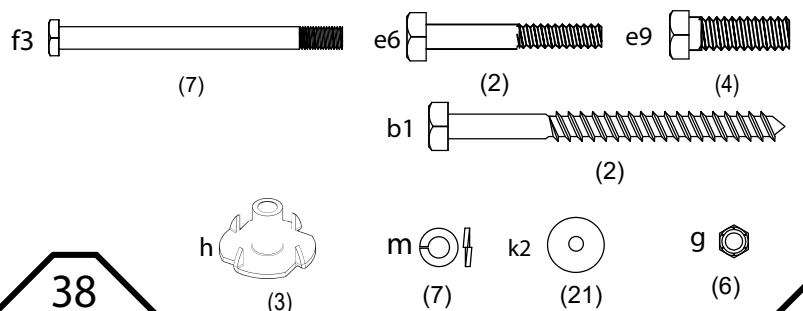

SWING BEAM ASSEMBLY

STEP 23 :

- * Install swing hangers in accordance with your accessory instructions.
- * Install both glider supports "BP 020" as shown.
- * Build two person glider (See diagram).
- * Hang the completed glider to glider support and fasten.
- * Hang both swings to the swing hangers and fasten.

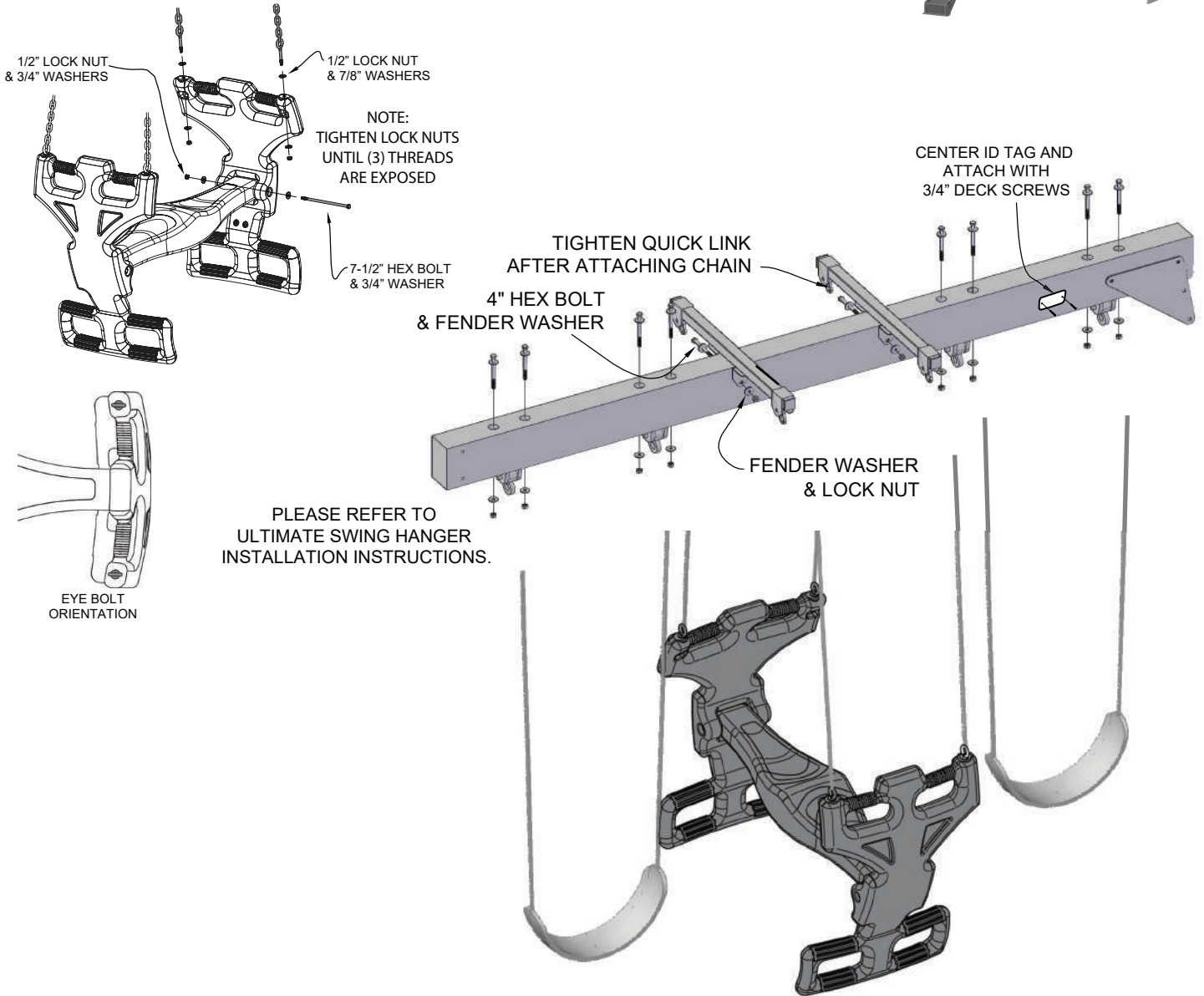
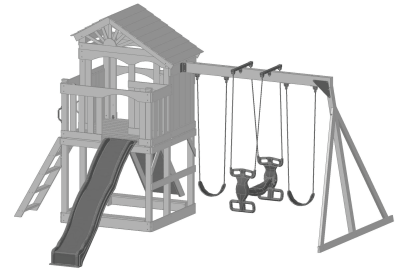

ITEMS NEEDED

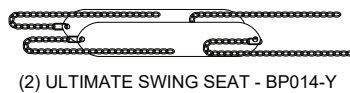
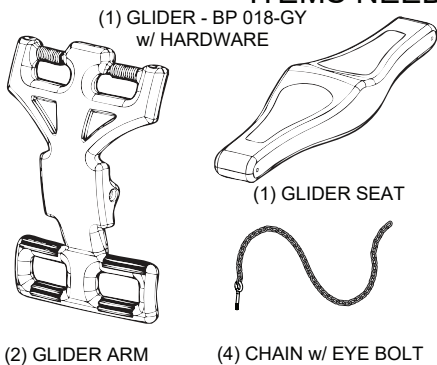

HARDWARE NEEDED

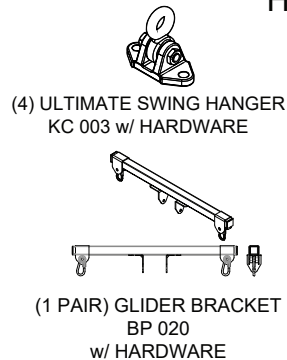

SLIDE ATTACHMENT

STEP 24 :

ALIGN SLIDE WITH PRE-DRILLED HOLES ON DECK.
INSTALL (1) 1" TRUSS HEAD SCREW IN THE
CENTER HOLE PER SLIDE.

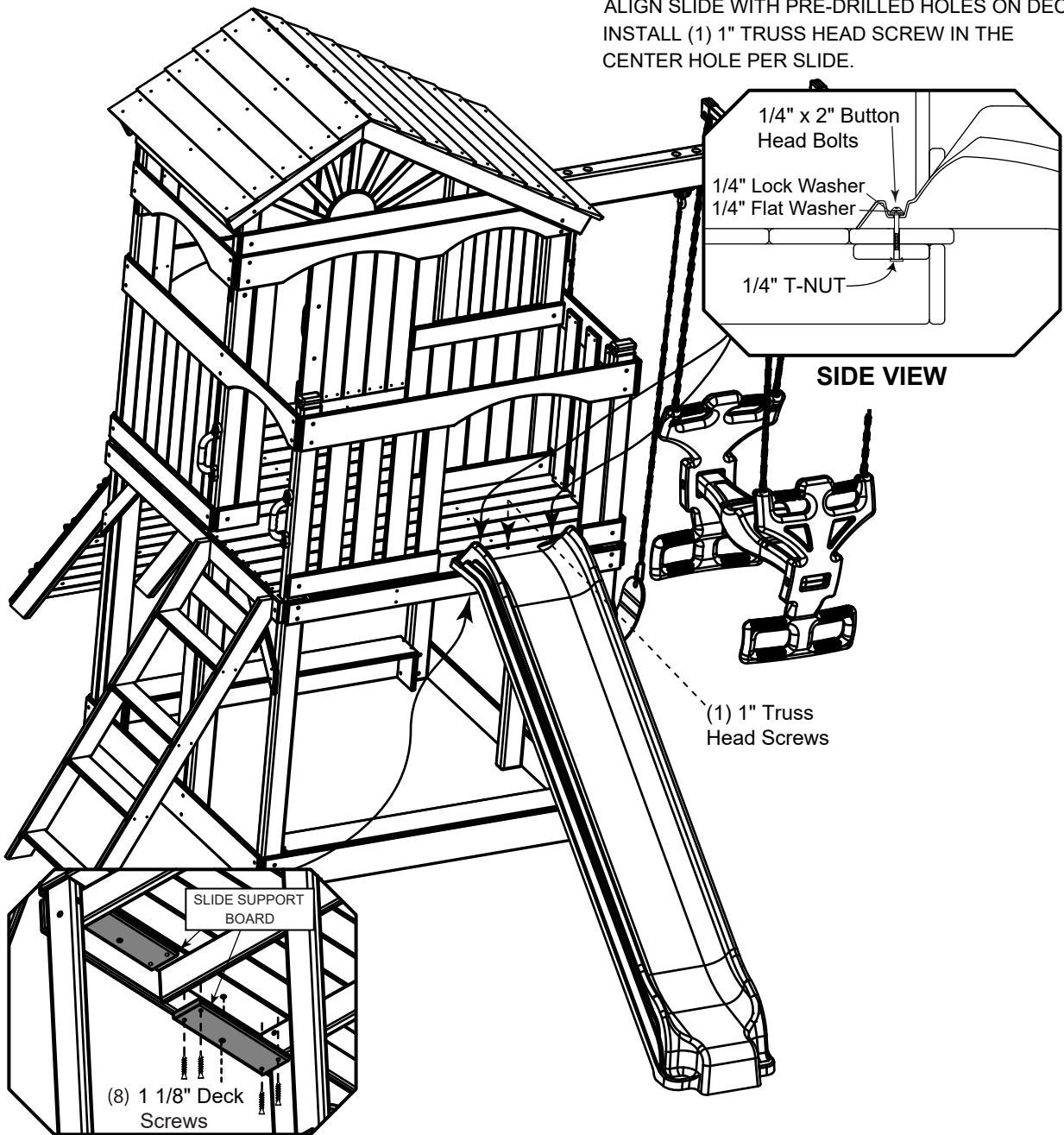

ALIGN HOLE IN SUPPORT BOARD
WITH HOLE IN UNDERSIDE OF DECK BOARD

ITEMS NEEDED



(1) 8' SLIDE

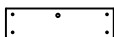

(2) WD116 - SLIDE SUPPORT BOARD - 11/16" X 3 1/2" X 12"

HARDWARE NEEDED

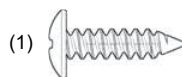

(1) 1" Truss Head Screws

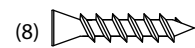

(8) 1 1/8" Deck Screws

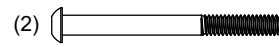

(2) 1/4" x 2" Button Head Bolts

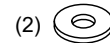

(2) 1/4" Flat Washer



(2) 1/4" Lock Washer

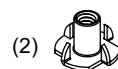

(2) 1/4" T-Nut

ANCHORING

STEP 25 :

- * Place six stakes in to the ground next to the playset as shown.
- * Secure the stakes with hardware shown (See diagram).



Note: Failure to use stakes can void warranty & cause injury.
Final Step: Double check and make sure every bolt, screw and nut is tight. Make sure every board is secure. Make sure the fort is level and enjoy your playset.

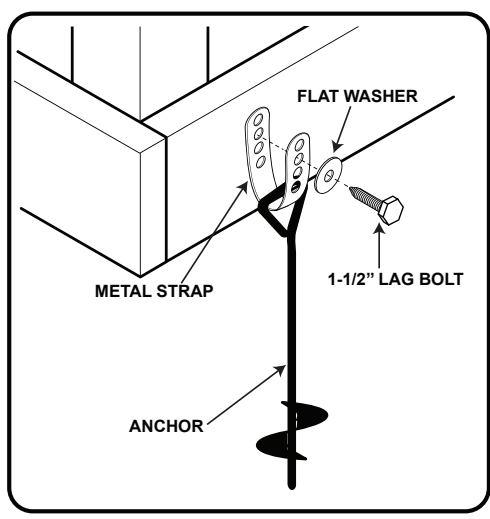
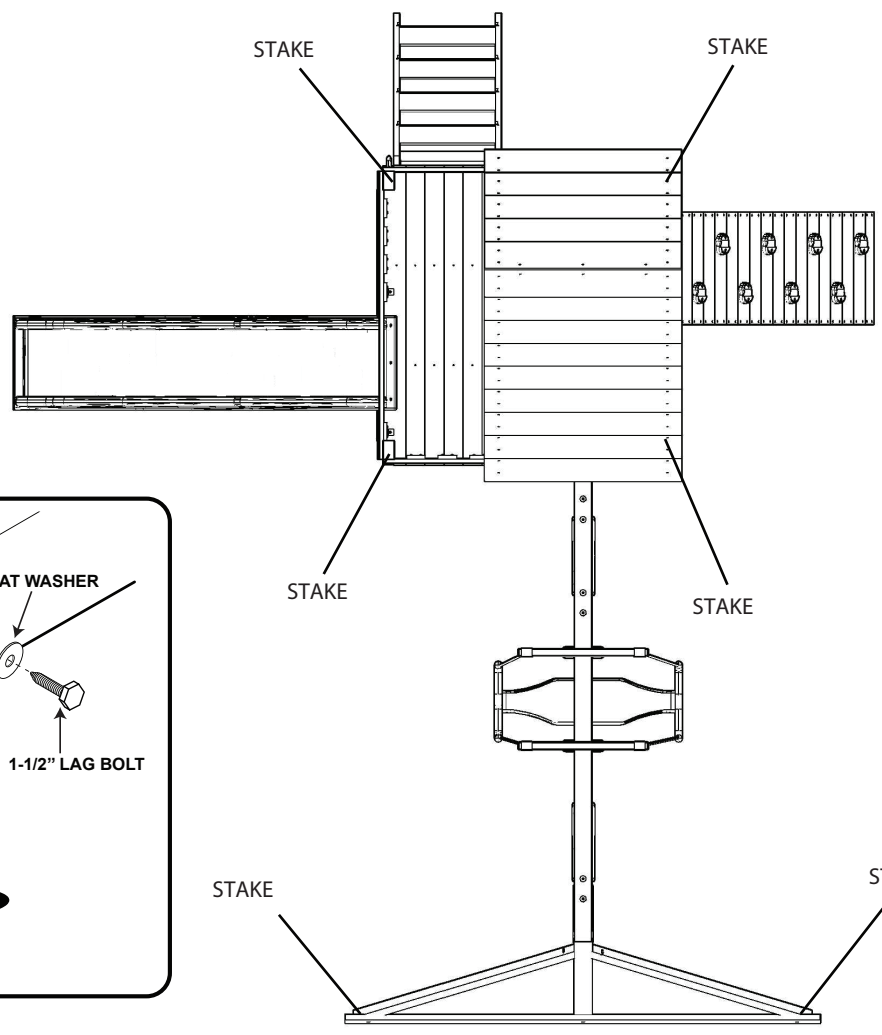

ITEMS NEEDED



HARDWARE NEEDED

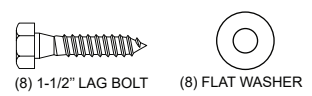

LIMITED WARRANTY

Creative Cedar Design (CCD) offers many fun, interactive, and safe play sets. We only guarantee the original purchaser that this product is free of defects for 30 days from the date of purchase. The product registration card, along with a dated purchase receipt, must be returned to CCD within 30 days.

Within a 30 day period, CCD will repair or replace, at our option, defective merchandise free of charge, provided that the defective part is a manufacturer's defect and not seasonal check. CCD requires photographs of the part in question. The customer service center must be contacted for authorization for all warranty related service. After the 30 day period, the customer is responsible for all shipping and handling charges, even if the warranty claim has been approved. Depending on the size of the part, quantity of the order, availability of part at the time, the claim can take between 1-3 weeks.

Under this warranty there will be a replacement for the defective component of the play set. A 1-year Warranty is available on all components with a manufacturer's defect. A 10-year Limited Warranty is available on wood parts (4x6 and 4x4) against wood rotting and termite damage. This guarantee is effective only if the product is used for the purpose for which it was designed, maintained with accordance to the instructions, and installed at a residential, single family dwelling.

The warranty does not cover, (a) products which have been damaged by acts of God, negligence, misuse, or accident, or which have been modified or repaired by unauthorized persons; (b) the cost of labor; (c) the cost of shipping the product, any part, or any replacement product or part; (d) damage caused by the addition of any accessories not sold by CCD.

Cosmetic defects that do not affect the structural integrity of the product, or natural defects of wood such as warping, checking or any other physical properties of wood that do not present a safety hazard, are not covered by this warranty. Defects that develop because the product is exposed to extreme climate conditions are not covered by this warranty. Defects that develop as a result of faulty or improper installation of the product are also not covered by this warranty.

For warranty service or replacement part information, please visit our website at www.creativecedardesigns.com and submit a request. If you have any additional questions, please call 1-888-363-4967.

Replacement parts are available for purchase after the warranty expires. Please contact us by email at custservice@creativecedardesigns.com for details.

Warranty: 1 Year for all Components	
Days from Date of Purchase	Cost to Customer
With in 30 days	No Cost
After 30 days , but within 1 year	Shipping and Handling (S&H)

Warranty: 10 Year Pro Rated for Wood Parts (4x4 and 4x6 ONLY against wood rot and termite damage)	
Years from Date of Purchase	Cost to Customer
0-1 (after first 30 days through Year 1)	Cost of S&H and 0% on part
2-3	Cost of S&H and 20% on part
4-5	Cost of S&H and 40% on part
6-7	Cost of S&H and 60% on part
8-9	Cost of S&H and 80% on part
Over 10	Cost of S&H and 100% on part

Warranty claim procedure

If you are confident that your play system has been installed and maintained properly, and you have a warranty claim, proceed with the following steps:

1. We will need copy of your proof of purchase (Vendor sales receipt only.)
2. We require a brief written description of the warranty issue.
3. Photos of warranted parts and of the entire play system.

If **any** of the above steps are not completed, there may be delays in the completion of your claim, or possibly warranty cancellation.

Mail information to:

Creative Cedar Designs

PO Box 4901

Chattanooga, TN 37405

Or email at

custservice@creativecedardesigns.com

Our customer service department will review the claim and make contact with the customer by mail or by phone.

1-888-363-4967

PRODUCT REGISTRATION CARD

Please complete this Product Registration Card along with a copy of the receipt and return to Creative Cedar Designs, within 30 days of original purchase in order to validate time of purchase for warranty. Or register at www.creativecedardesigns.com

Name: _____

Address: _____

City, State, Zip Code: _____

Phone: _____

Email Address: _____

Date of Purchase: _____

Purchased Through: _____

City, State, Zip Code: _____

Playset Name: _____ Playset Model: _____

Overall, how would you rate the quality of our product?

- Excellent
- Good
- Satisfied
- Poor
- Unsatisfied

Would you recommend our product to family and friends?

- Yes
- No

What age group are your children?

- 3-4
- 5-6
- 7-8
- 9-10

How did you hear about us?

- In Store Display
- Sales Person
- Advertisement
- Internet
- Family and Friends

Additional Comments: _____

PRODUCT REGISTRATION CARD

Please complete this Product Registration Card along with a copy of the receipt and return to Creative Cedar Designs, within 30 days of original purchase in order to validate time of purchase for warranty.

FOLD HERE

Place
Stamp
Here

Creative Cedar Designs

PO Box 4901

Chattanooga, TN 37405