

Sideboard

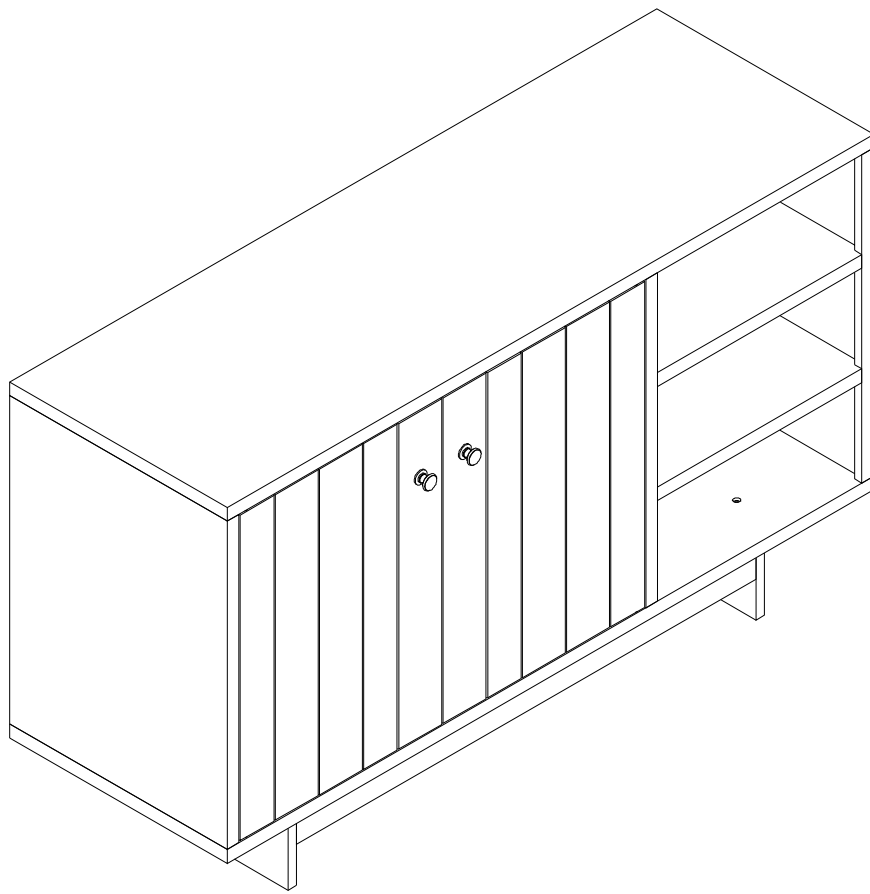

Congratulations! You have purchased a stylish piece of us. We strived to provide fine furniture products, built with quality materials and hand finished details. Please carefully follow the assembly instructions to ensure your furniture is assembled correctly to provide long lasting enjoyment.







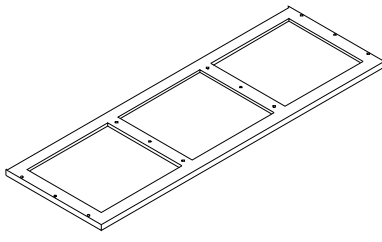
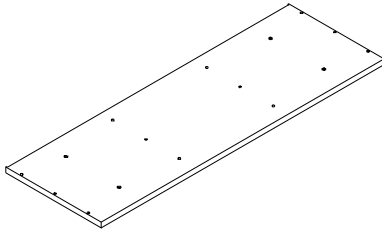
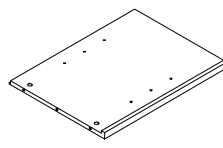
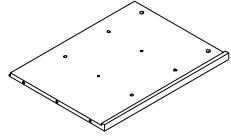
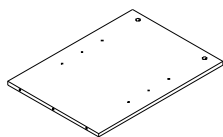
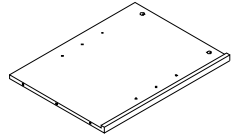
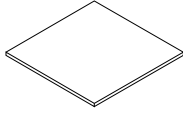
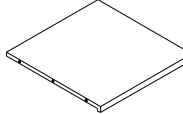
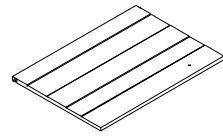
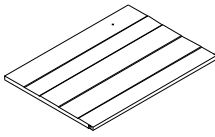
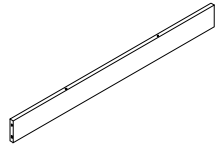
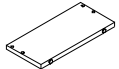
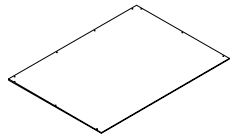
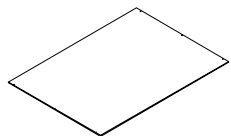

Should you experience any missing or damaged parts, **do not return to the store**. Please visit our website or contact us directly.

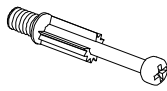
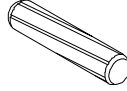
Care: Use a soft clean cloth that will not scratch the surface when dusting. Use of furniture polish is not necessary. Should you choose to use polishes, test in an inconspicuous area first. Use of solvents of any kind may damage your furniture's finish. To clean, simply use a soft clean cloth moistened with lukewarm water, then buff with a dry soft clean cloth.

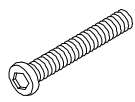
PART LIST

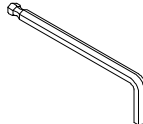
					
Top Panel		Bottom Panel		Left Side Panel	
1	1pc	2	1pc	3	1pc
					
Right Side Panel		Left Partition Panel		Right Partition Panel	
4	1pc	5	1pc	6	1pc
					
Adjustable shelf		Fixed Shelf		Left Door	
7	2pcs	8	2pcs	9	1pc
					
Right Door		Bottom Horizontal Rail		Bottom Side Rail	
10	1pc	11	2pcs	12	2pcs
					
Side Back Panel		Middle Back Panel			
13	2pcs	14	1pc		

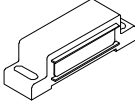
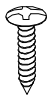
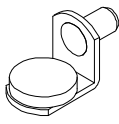
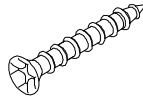
HARDWARE LIST

	Cam Lock Ø15*12mm		Cam Bolt Ø6*42mm		Wood Dowel Ø8*30mm
A	16pcs	B	16pcs	C	14pcs
	Short Hex Socket Head Bolt Ø6*35mm		Long Hex Socket Head Bolt Ø6*50mm		Barrel Nut Ø6*12mm
D	12pcs	E	8pcs	F	8pcs
	Allen Key 4mm		Knob Ø32*23mm		Round Head Bolt Ø5/32**19mm
G	1pc	H	2pcs	I	2pcs
	Magnet L45*H12mm		Round Head Screw Ø3*15mm		Shelf Holder Ø6.5mm
J	2pcs	K	26pcs	L	8pcs
	Flat Head Screw Ø3.5*50mm		Safety Strap Kit		
M	4pcs	N	1pc		

EXTRA HARDWARE LIST

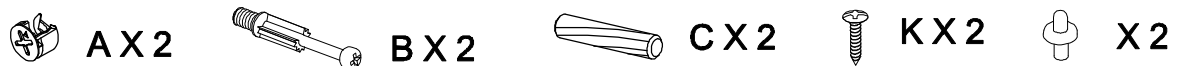

ADDITIONAL TOOLS (Not Provided)

Note: It is not recommended to use power tools during assembly. You may use power tools to assist in mounting the safety strap kit to the wall.

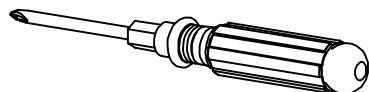

Phillips Head Screw Driver

IMPORTANT NOTE: WE RECOMMEND TWO PEOPLE WORK TOGETHER TO ASSEMBLE THE PRODUCT

Step 1. Insert Cam Bolts (B) into pre-drilled holes of parts 1,4,6 using a Phillips head screw driver as shown. Do not over tighten.

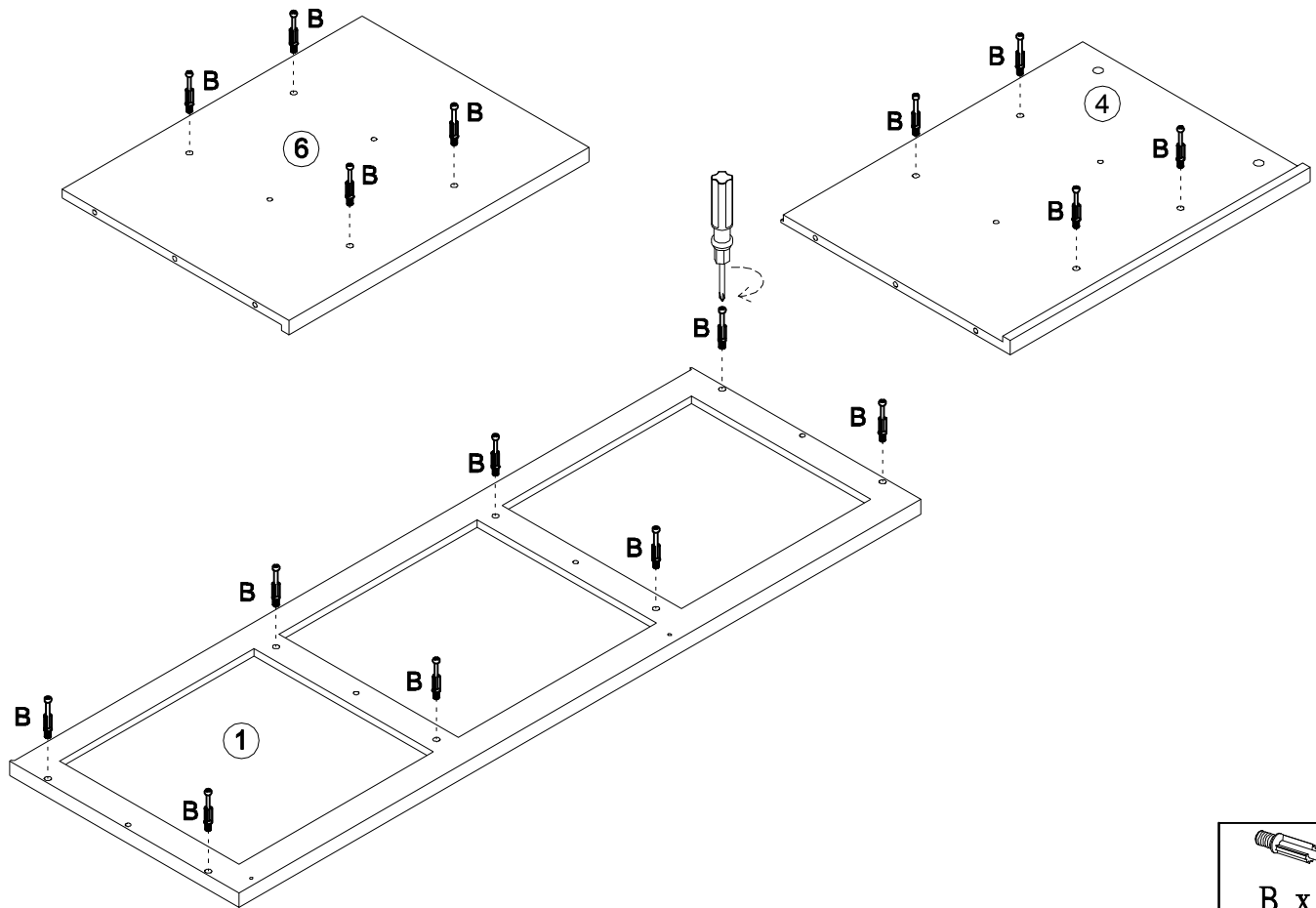

Step 2. Attach Knobs (H) to Doors (9 & 10) using Round Head Bolts (I) .
Attach Magnets (J) to pre-drilled holes of Left Partition Panel (5) using Round Head Screws (K) as shown.

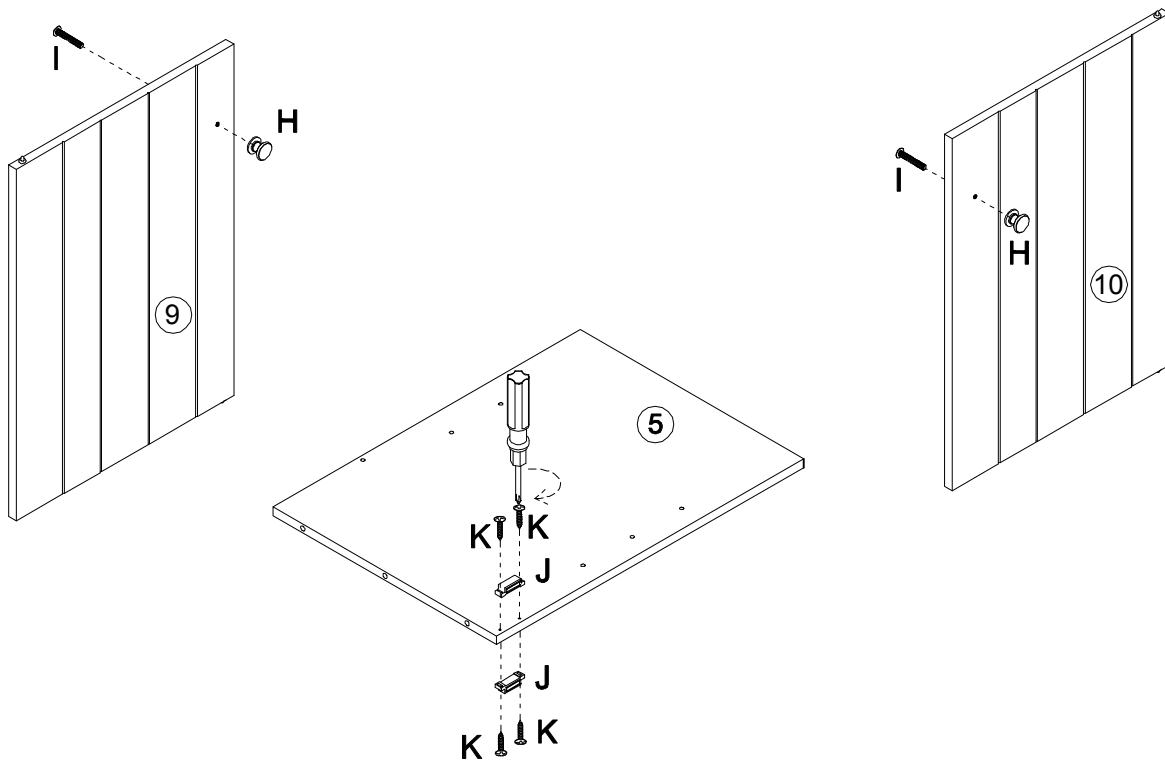

4 of 11



J x 2



K x 4





H x 2



I x 2

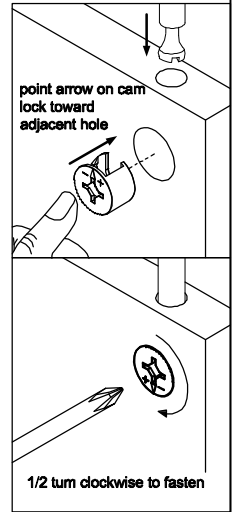
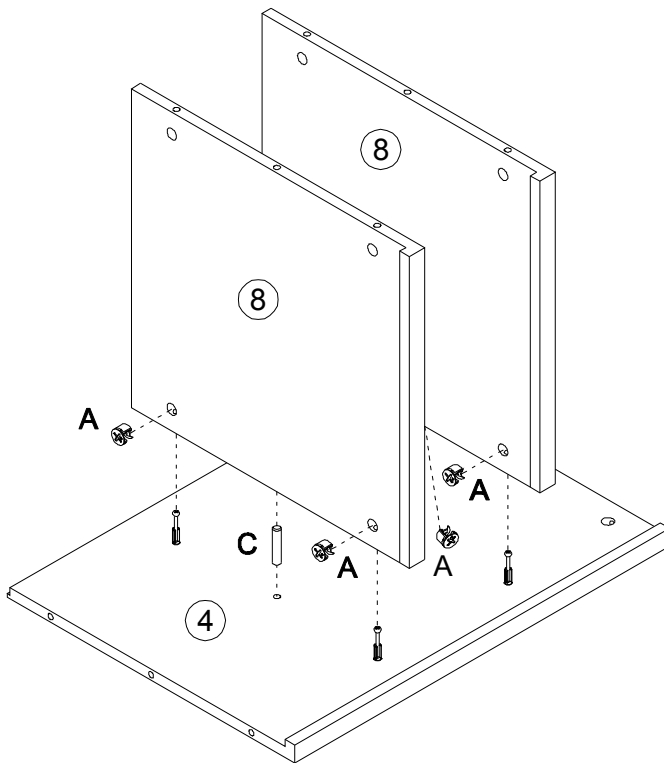

Step 3. Attach Fixed Shelves (8) to Right Side Panel (4) using Wood Dowels (C) and Cam Locks (A) as shown.



	
A x 4	C x 2

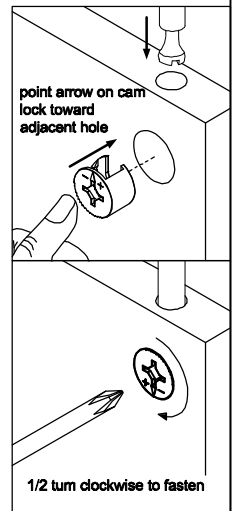
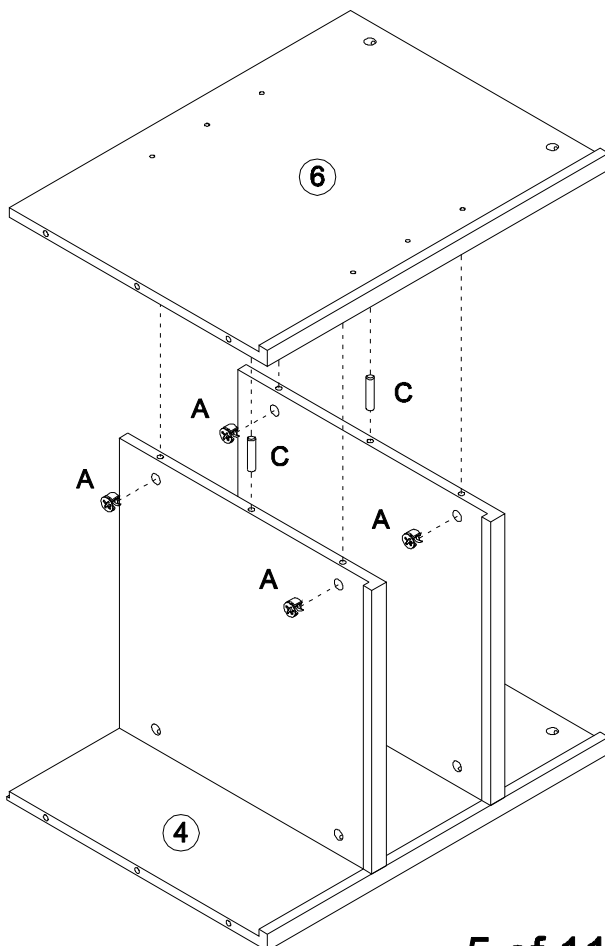

Step 4. Attach Right Partition Panel (6) using Wood Dowels (C) and Cam Locks (A) as shown.



	
A x 4	C x 2

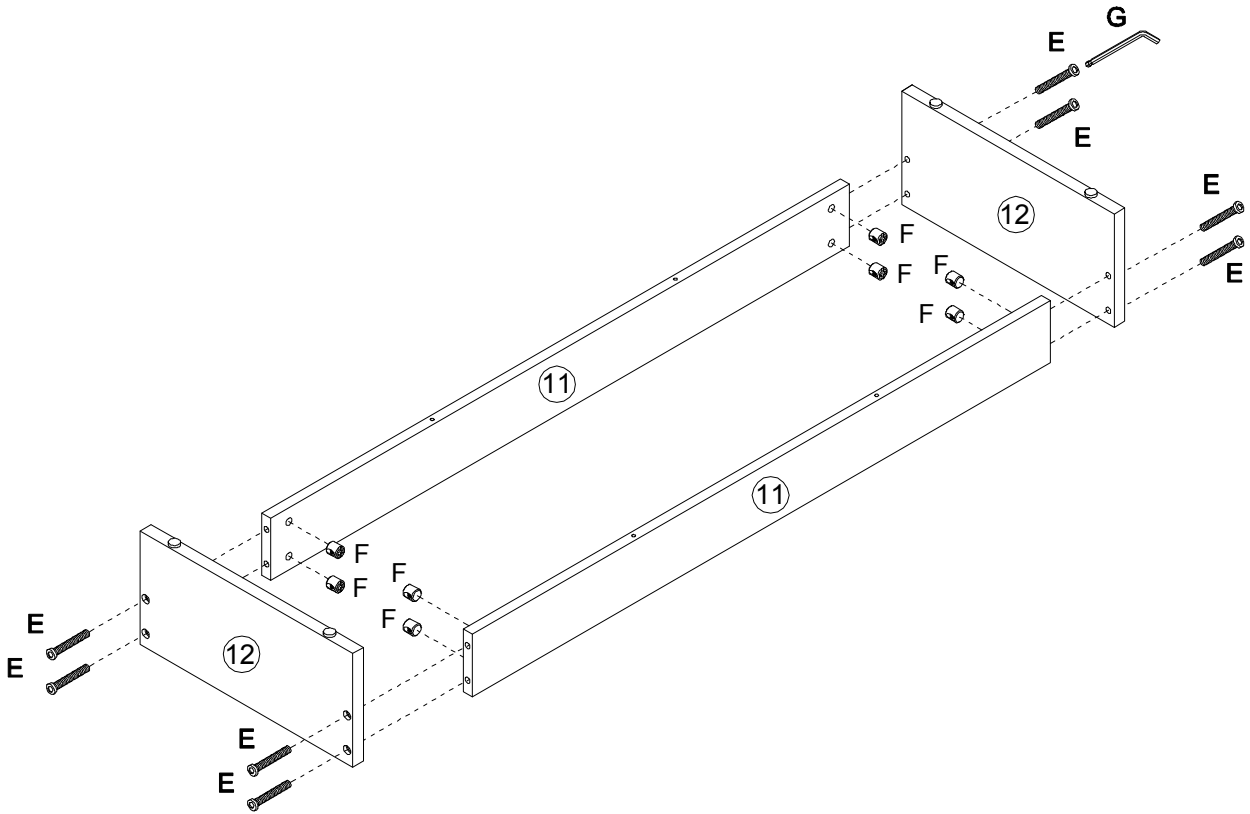

Step 5. Attached Bottom Side Rails (12) to Bottom Horizontal Rails (11) using Long Hex Socket Head Bolts (E), Barrel Nut (F) as shown.



 E x 8	 F x 8
--	--

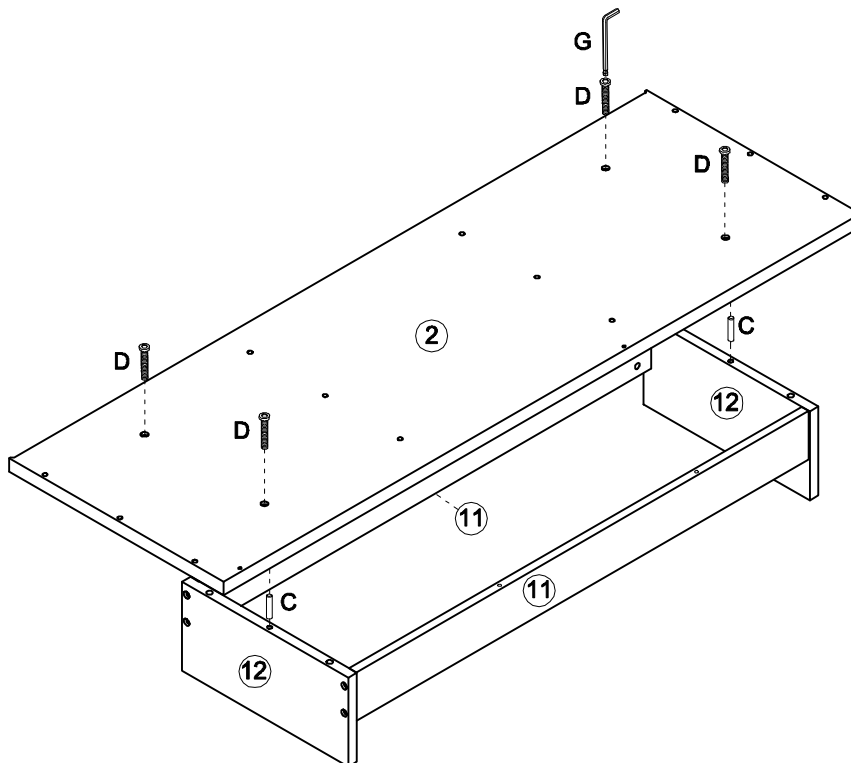

Step 6. Attach Bottom Panel (2) to Rails (11&12) using Wood Dowels (C), Short Hex Socket Head Bolts (D) and Allen Key (G) as shown.



 C x 2	 D x 4
--	--

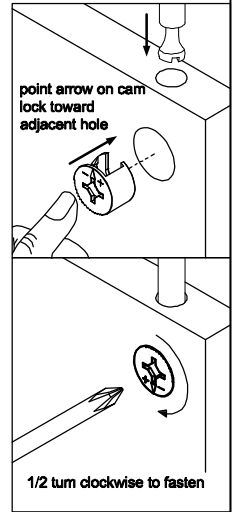
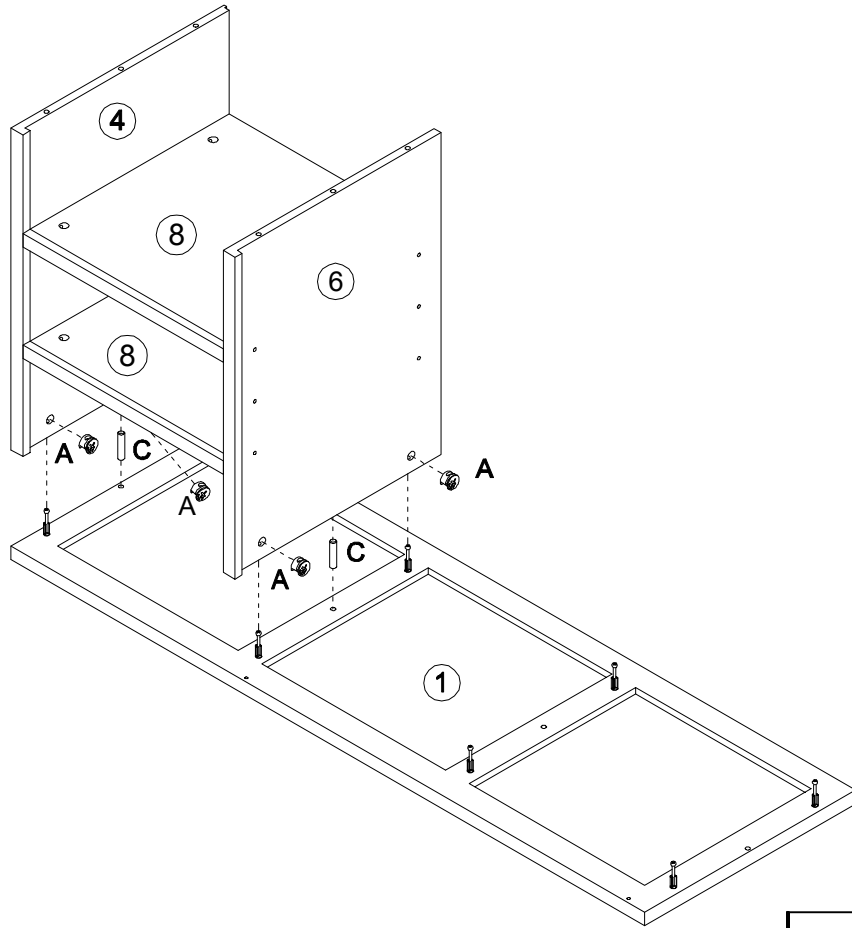

Step 7. Attach assembled parts (4,6,&8) to Top Panel (1) using Wood Dowels (C) and Cam Locks (A) as shown.



	
A x 4	C x 2

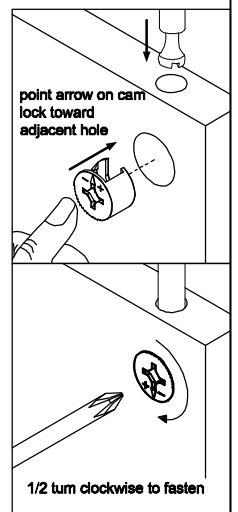
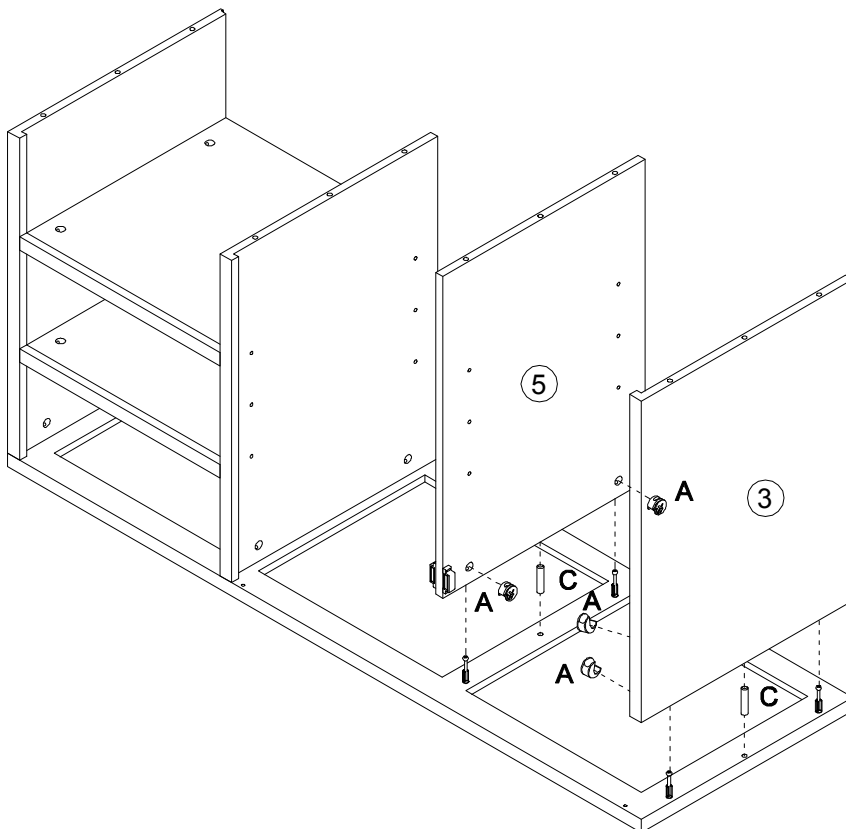

Step 8. Attach Left Side Panel (3) and Left Partition Panel (5) to Top Panel (1) using Wood Dowels (C) and Cam Locks (A) as shown.

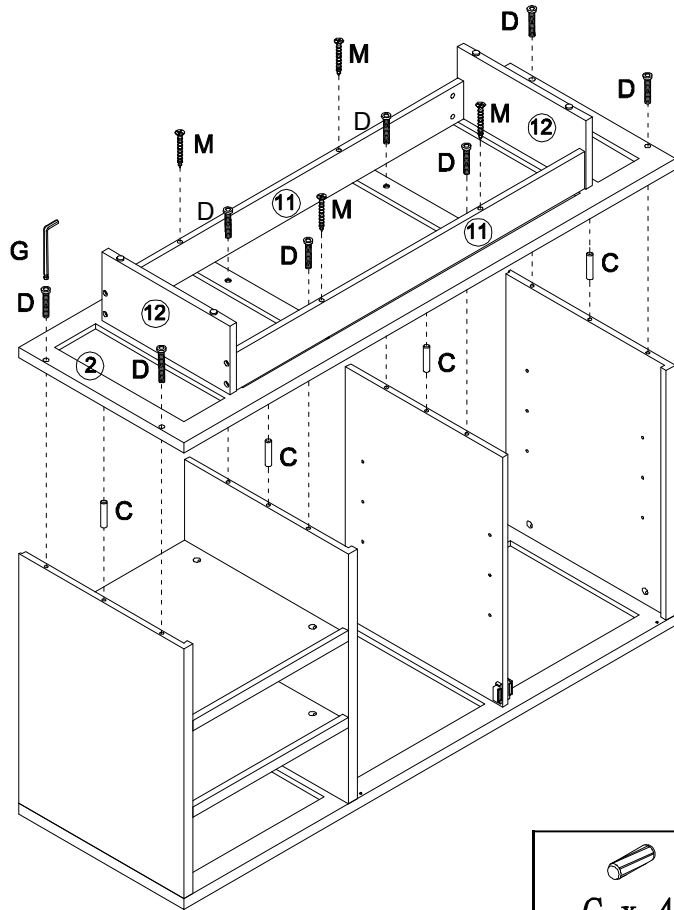

	
A x 4	C x 2

Step 9. Attach assembled parts (2,11&12) to cabinet using Wood Dowels (C) ,Short Hex Socket Head Bolts (D) ,Flat Head Screw (M) and Allen Key (G) as shown.



		
C x 4	D x 8	M x 4

Step 10. Carefully turn the cabinet with top face up. Attach Doors (9 &10) to cabinet by placing bottom Pin Hinge into pre-drilled holes in Base (2) & depressing top spring loaded pin hinge to fit the door into place in Top (1) .

Note-Be sure Pin Hinges (top &bottom) have fully extended into the pre-drilled holes in Base (2) and Rail (11) to secure doors into place .

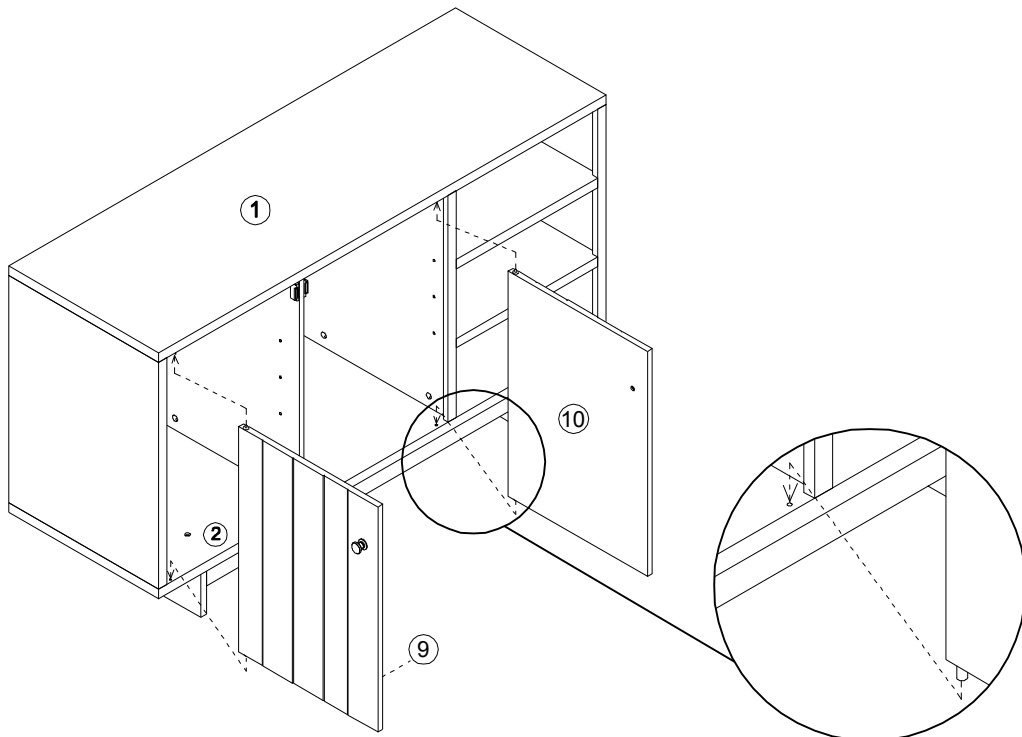



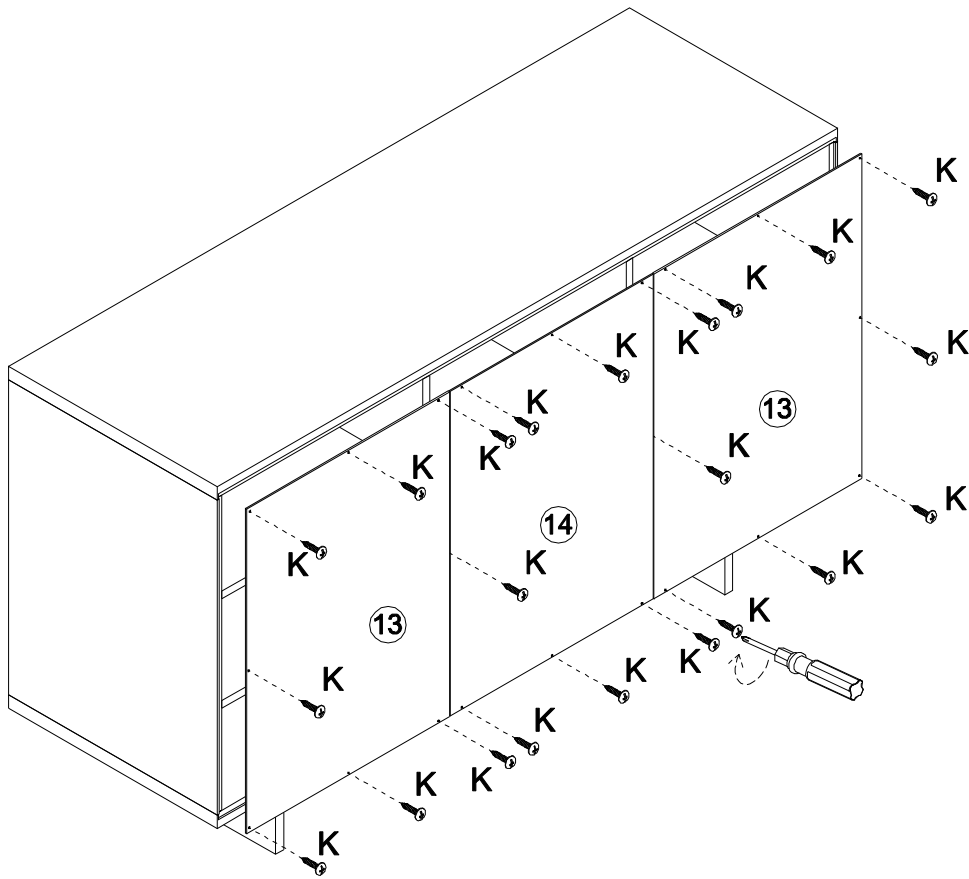

Step 11. Attach Side Back Panel (13) and Middle Back Panel (14) to cabinet using Round Head Screws(K) as shown.

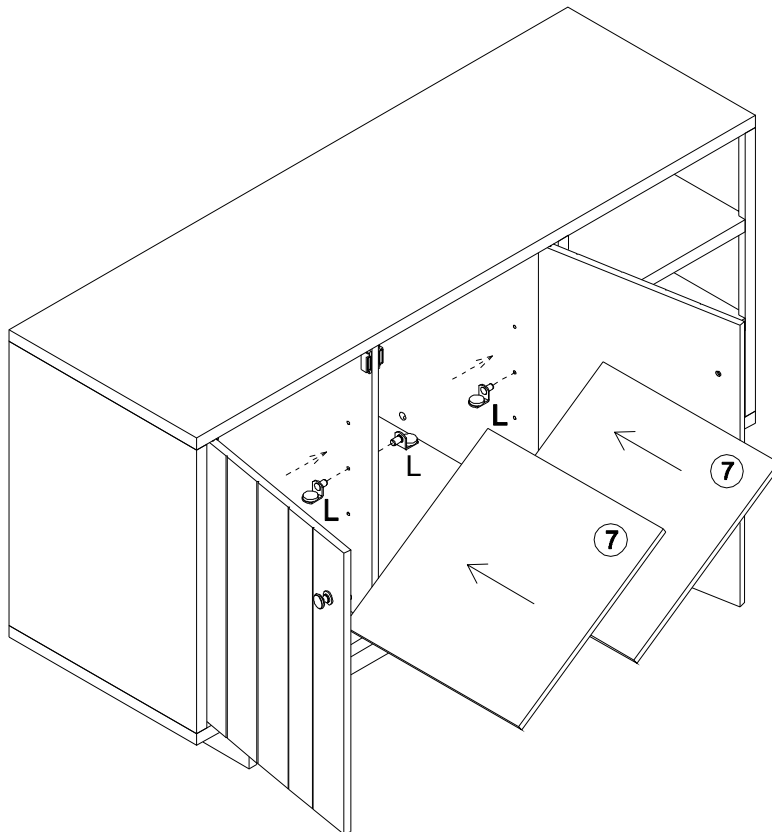

Step 12. Insert the Shelf Holders (L) into desired position. Insert Adjustable shelf (7) into cabinet.

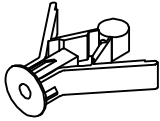

Step 13.

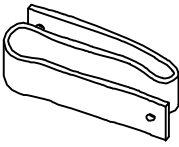
N 	A 	B 	C 	D 	E 
SAFETY STRAP KIT 1PC	WALL ANCHOR A x 1PC	WASHER B x 2PCS	SHORT SCREW C x 1PC	LONG SCREW D x 1PC	SAFETY WALL STRAP E x 1PC

SAFETY WALL STRAP ASSEMBLY INSTRUCTION

1) Insert Short Screw Part (C) through Washer Part (B) and Safety Wall Strap Part (E) and screw it into Top Panel (1).

2) Drill a $1\frac{1}{32}$ " hole where you want to secure your pantry. The hole should be at the same height as the hole in Top Panel (1). Tap Wall Anchor Part (A) into the hole.

3) Insert Long Screw Part (D) through a Washer Part (B) and Wall Safety Strap Part (E) into Wall Anchor Part (A).

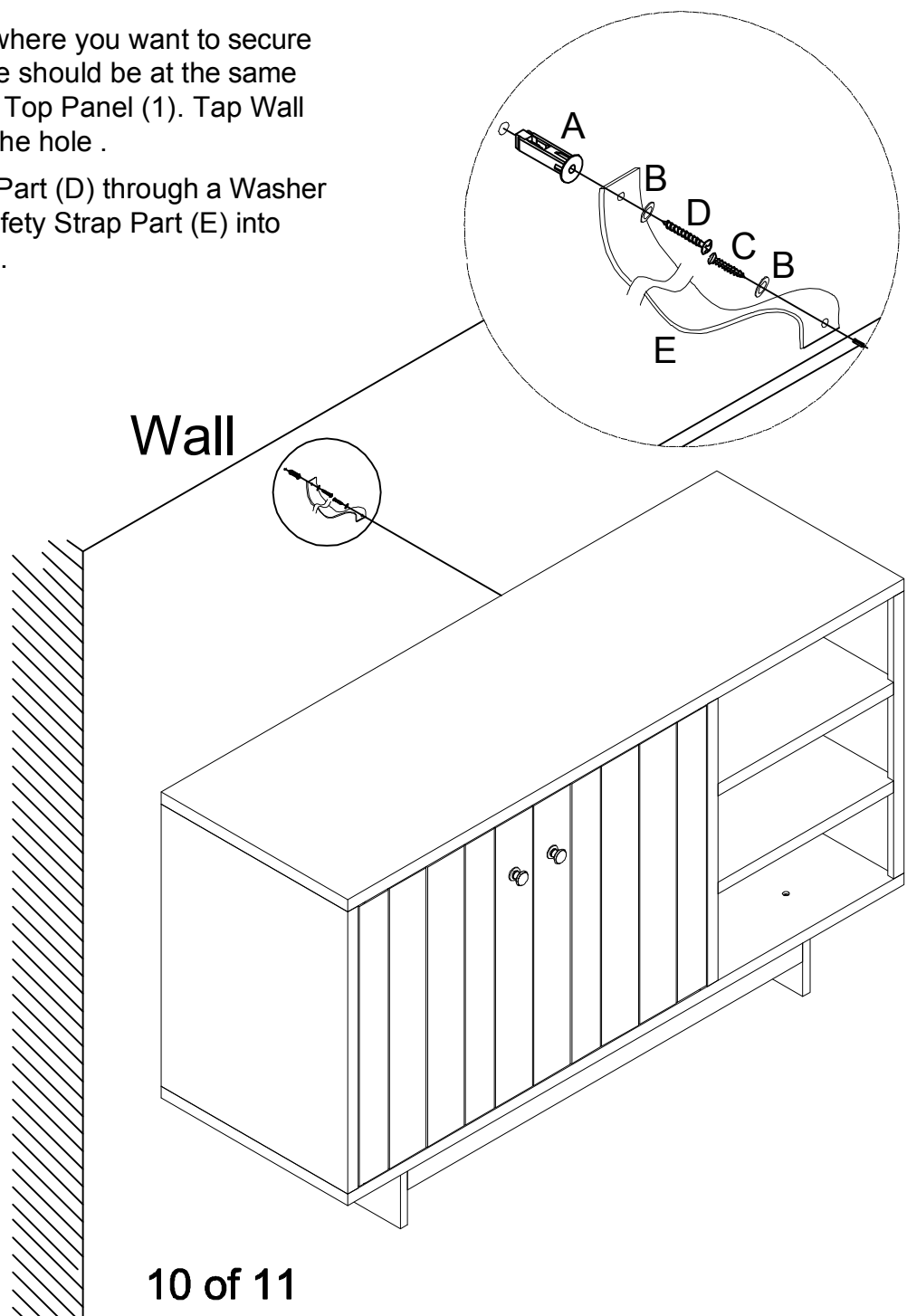

Limited Manufacturer Warranty

Our products are warranted against defects in material and workmanship for a period of 90 days beginning from the date of sale. Should any parts be missing or defective, we will replace or repair the parts for a period of 90 days from the date of purchase.

Should you experience any missing or damaged parts, **do not return to the store.** Please visit our website or contact us directly.

This warranty gives the purchaser specified legal rights in addition to any rights which may vary from state to state.

In accordance with the "Moss-Magnuson Warranty Act" of July 10, 1975, this is termed a "limited warranty" which in no way compromises our high standards of Quality and Workmanship.