

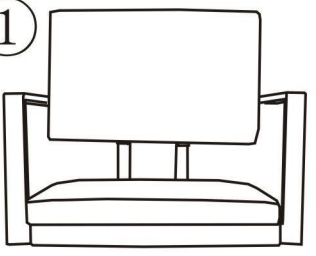

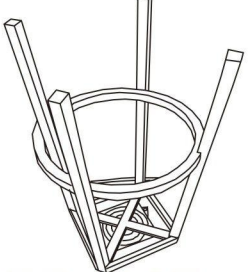

		Instaling		Accessories			Tool	
	①	②		③	④	⑤	⑥	
				SCREW	NUT	GASKET	ALLENKET	
	SEAT	FRAME						
			Size	M6*25	M6	Φ16*2*Φ8	Size	Φ4
Pcs	1	1		4	4	4		1

Step1



Step2

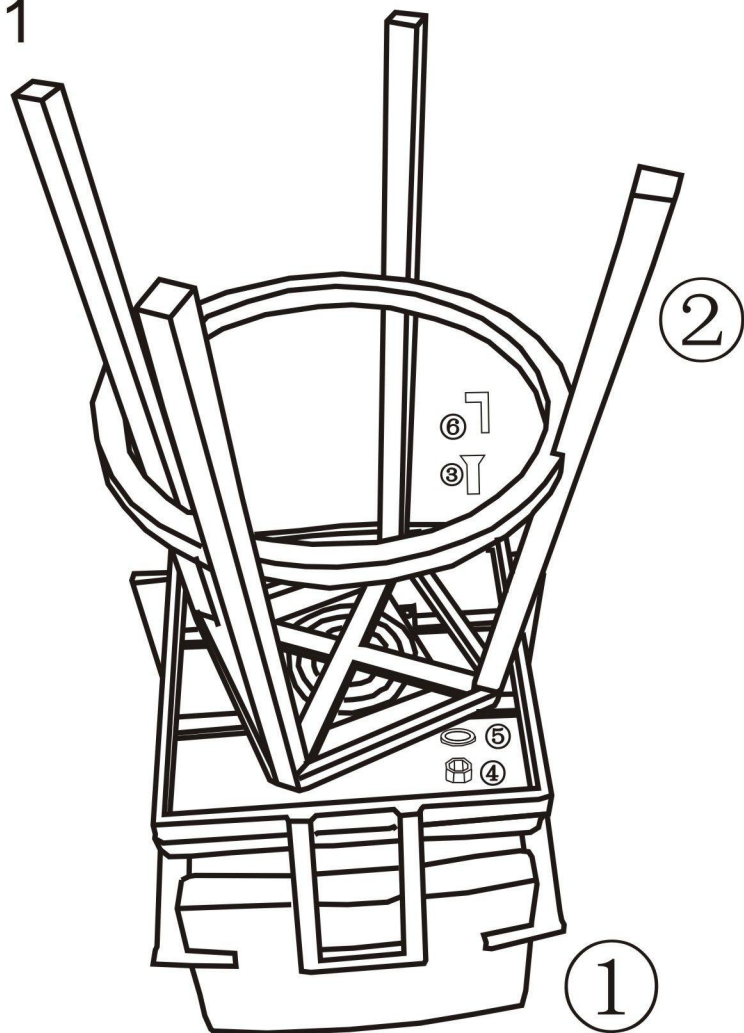