

4-Light Glass Wall Sconce

Caution: Please turn off power before installation and read the manual carefully, we advise you contact professional electricians to install for safety purpose.

Product Features

Style: Modern

Material: Metal, Glass

Base Type: E12

Light Source Included: NO

Voltage: 120VAC

Wattage: 60W

Package includes

1 x Wall Light

1 x Accessories Kit

1 x User's Manual

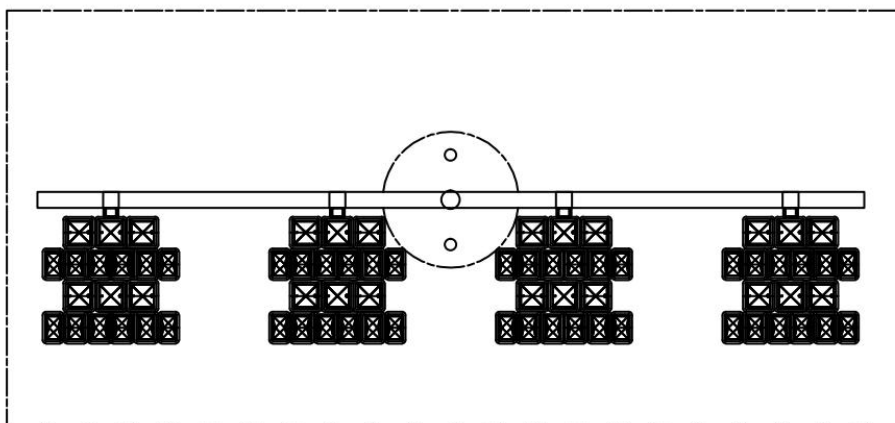
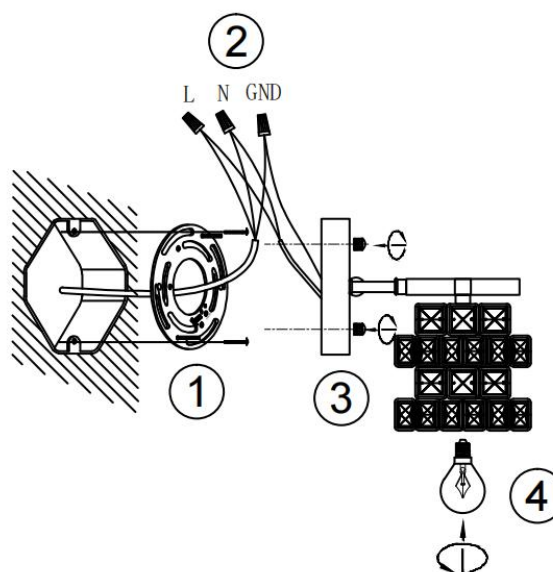

Installation Instructions

1. Fix the backplate to the junction box with screws
2. Connect the main wire and ground wire of the lamp body with the wire reserved on the junction box
3. Cover the ceiling plate on the backplate, and then tighten the cap nuts to fix the ceiling plate
4. Install the light bulb (not included)

Note: please use this product accordingly to its intended purpose, do not retrofit or remodeling the product. The warranty does not cover if the failure is caused by the third party product, or natural disasters.

Made in China