

Assembly Instruction

Square Side Table

Your furniture requires assembly prior to use. It is important that you read the entire assembly instructions to become familiar with the unit before you set up this product.

Safety Warning and Precautions

WARNING: When setting up your furniture, basic precautions should always be followed to reduce risk of personal injury and damage to the product.

Read all instructions before assembly and usage this product.







1. Select ideal location. Set out all parts on a clear and level surface prior to assembly. Ideally, the furniture should be set up in the desired location to avoid moving it after assembly.
2. Use caution. During all the processes of assembling, especially when lifting heavy or large parts, pay attention to safety.
3. Tools and Assistance. An adjustable spanner is required for assembly. It is recommended 2 people assist with assembly.
4. Check all parts before assembling, ensure you have all parts detailed in the parts list on Page 2.
5. Refer to assembly diagram. During assembly, refer to the assembly instructions on following pages.
6. Caution. Keep children away from work area during assembly. Do not allow children to handle parts or tools while assembling.

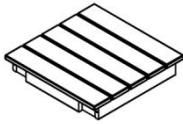

Assembly Instruction

Square Side Table

PANEL AND FITTINGS IDENTIFICATION

Part #	A	B	C	D	E	F
Description:	Table Top	Table Leg B	Table Leg C	Screw M6*50	Bolt M6*30	Allen Wrench M5
Figure:						 M5
Qty:	1	2	2	4	4	1

Part #	G					
Description:	Allen Wrench M4					
Figure:						
Qty:	1					

Assembly Instruction

Square Side Table

Step1.

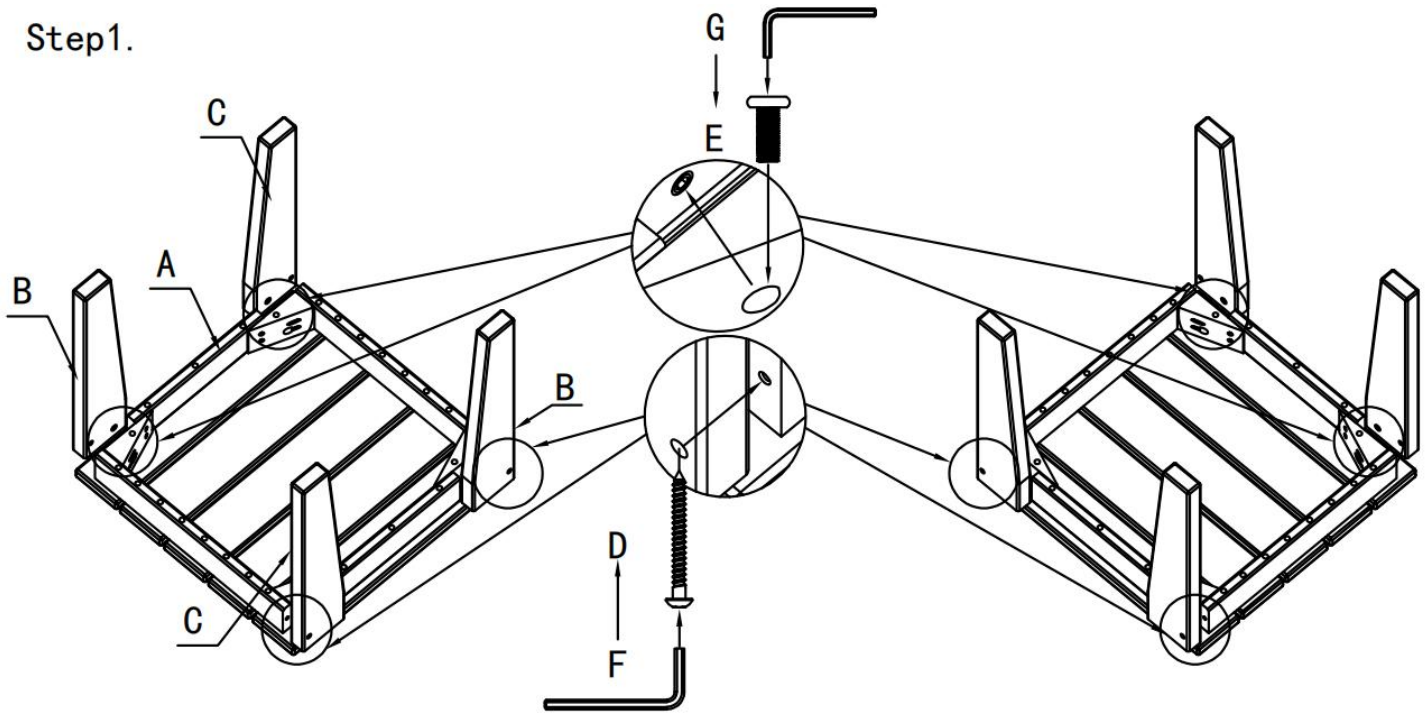

Step:

1. Attach the Table Legs B (Part B) and Table Legs C (Part C) to the Table Top (Part A) with Bolts M6*30 (Part E) and Screws M6*50 (Part D) (Part D) by using the Allen Wrench M5 (Part F) and Allen Wrench M4 (Part G).

Tighten all screws. Your chair is ready to use. (Note: All screws shall be loose-fitted to corresponding holes and then tighten them together.)

Periodically check and make sure that all screws are fully tightened.