

ASSEMBLY INSTRUCTIONS

2430-151 CREDENZA

LEGACY

CLASSIC | MODERN



Thank you for purchasing this quality product. Before beginning, please check the packing material carefully for small parts which may have come loose inside the carton during shipping. Please do not discard any packing material until all parts have been located. If any parts are missing, please contact your dealer for prompt replacement.



Caution: (1) These parts are cumbersome and heavy. This product can best be assembled with the assistance of one or more persons in order to prevent personal injury and to ensure parts are not damaged during the assembly process. If dirty, clean finished parts with mild dishwashing liquid and water solution applied on damp cloth. Cloth should not be excessively wet. Polish finish with soft cloth and an industry recognized furniture polish.

(2) To prevent damage to your floor or carpet, please check the bottom of each piece of furniture for stain residue and rough surfaces and also check for staples or nails left after removing the packaging material. The manufacturer will not be held responsible if preventative steps are not taken prior to installation.

(3) During normal use every day, screws, bolts, nuts and wooden plugs may loosen up. They should be periodically inspected and re-tightened to prevent damage to the furniture and (or) personal property or cause injury. Always check to be sure all hardware on this list and the below mentioned components are attached to the furniture properly and kept tightened.

Parts & Hardware List:

NO	PARTS LIST	QTY.
A	CREDENZA 	1 PC
B	WINE SHELF 	2 PCS
C	SUPPORT LEG 	1 PC

NO.	HARDWARE LIST	QTY.	NO.	HARDWARE LIST	QTY.
#1	TIPPING RESTRAINT 	1 SET	#2	SHELF PIN 	8 PCS
#3	WOOD SCREW  #6 X 5/8"	8 PCS			

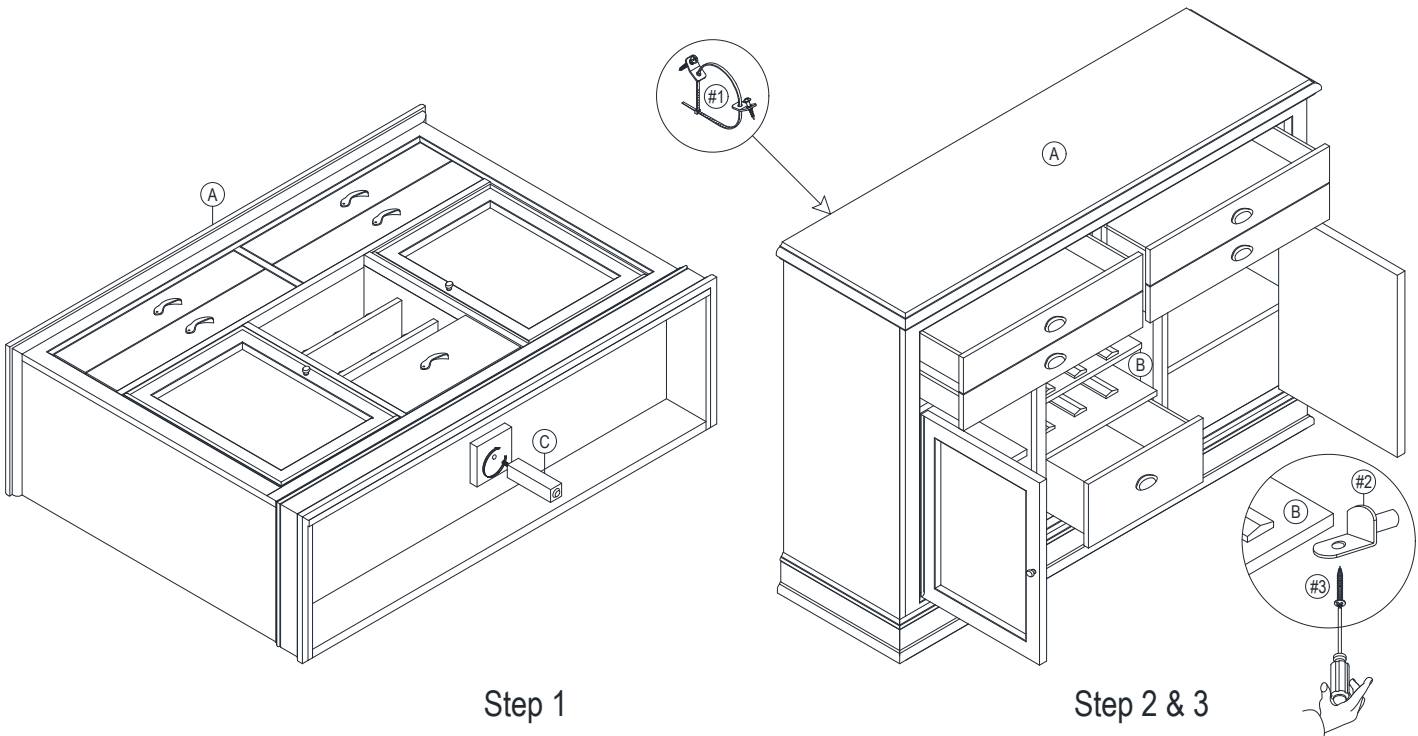

Assembly Steps:

Step 1: Lay out all parts and hardware on a clean protective surface to protect the furniture and the floor during assembly. Make sure the quantity of each is correct and all parts are free of stains, staples, screws, and nails.

Step 2: Place the credenza (A) back down on a clean soft flat surface such as a blanket and ensure the surface is clean of any object that could scratch or damage the credenza, adjust support leg (C) to support the credenza (A).

Step 3: Turn the credenza to its upright position. Install the wine shelf (B) to credenza (A) using hardware (#2, #3) as shown. Use adjustable leveler as necessary.

Step 4: Installing tip-restraint: Following the installation instructions that come in the tip-restraint package. Assembly is complete.

**Note: use a screwdriver to reverse the knobs to the outside of the doors as shown.