

## 0610 PC Outdoor Greenhouse

---

If you have any questions about the 0610 PC Outdoor Greenhouse, please feel free to contact us.  
Customer Service Email: [hgeurope@outlook.com](mailto:hgeurope@outlook.com)

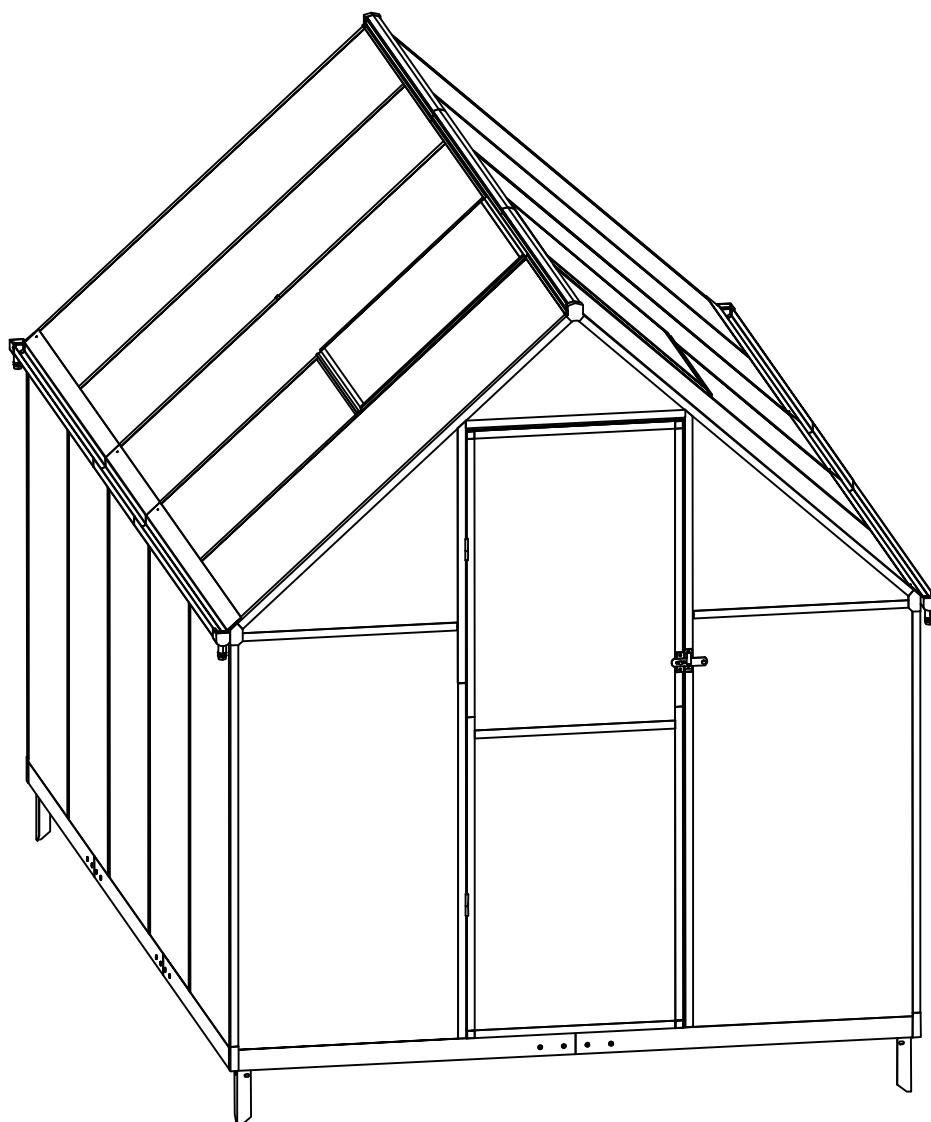

**P25809-D1**

**IMPORTANT**

**PLEASE READ BEFORE YOU COMMENCE ASSEMBLY**

Follow the guidelines in this user guide to ensure correct  
assembly and care for this product.

# SPECIFICATIONS

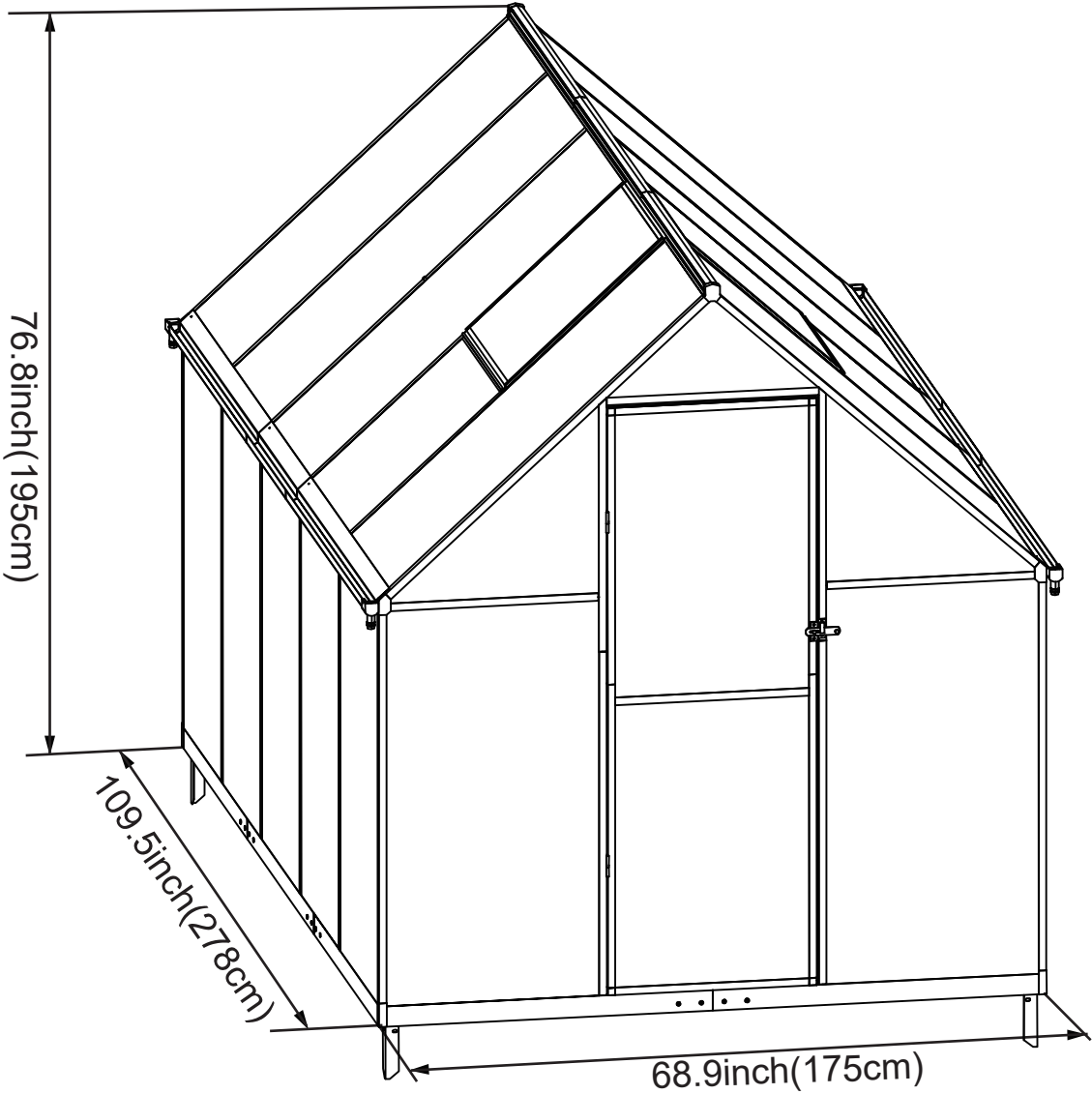

**Catalog**

Specifications ..... 01

Notice ..... 03

Warning ..... 03

Installation Notes ..... 04

Exploded Views ..... 05

Part List ..... 06

Extra ..... 12

How to Assemble the Greenhouse ..... 13

# NOTICE

**Please prepare below tools before installation.**

The following tools are not included and needed for assembly:



Pistol Drill



Tape Measure



Ladder

Package included Tools:



Screw Driver



Gloves

## Warning

We recommend two adults to complete the installation. Two adults installed together will make the installation process easier and safer.

The gloves must be carried to prevent hand cuts during installation. Take care when using power tools near water the use of a residual current device(RCD) is advised. Please use the electric driver carefully during screwing to prevent the screw from slipping and hurting your hand.

We recommend that beginners use a manual screwdriver for installation.

Be careful not to fall when installing the roof. Please steady the ladder and make sure the product placed on a flat ground.

## Installation Notes

Please check the quantity of all parts before installation (Please refer to the Part List) and the appearance of the products. Please make sure the product is correct before installation. If there is any problem, please contact us directly.

Make sure all the holes match. Please install the panels in the order specified in the instructions. All lines and holes must be accurately matched to make the PC Outdoor Greenhouse more stable. Please ensure that all screws are tightened to prevent the product from falling apart.

There is a protective film on the surface to protect the product, please tear it off after installation to get the final presentation.

Please place the product on a flat ground to prevent leaning and collapse. If the ground is uneven, the door may can't be closed.

### Attention:

Please read this instruction carefully before installation and follow it strictly during installation.

Ensure that there are no problems later due to installation errors.

UV-Label side to be installed outside ;

Film on both sides to be peeled off before installation.

**Note:** For the side with the label, only peel off the four edges of the film before installation.

The center section with the label should be peeled off after installation is complete to prevent installation errors caused by the label being obscured.

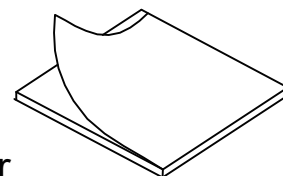

Contact US:

[Service@alaulm.com](mailto:Service@alaulm.com)







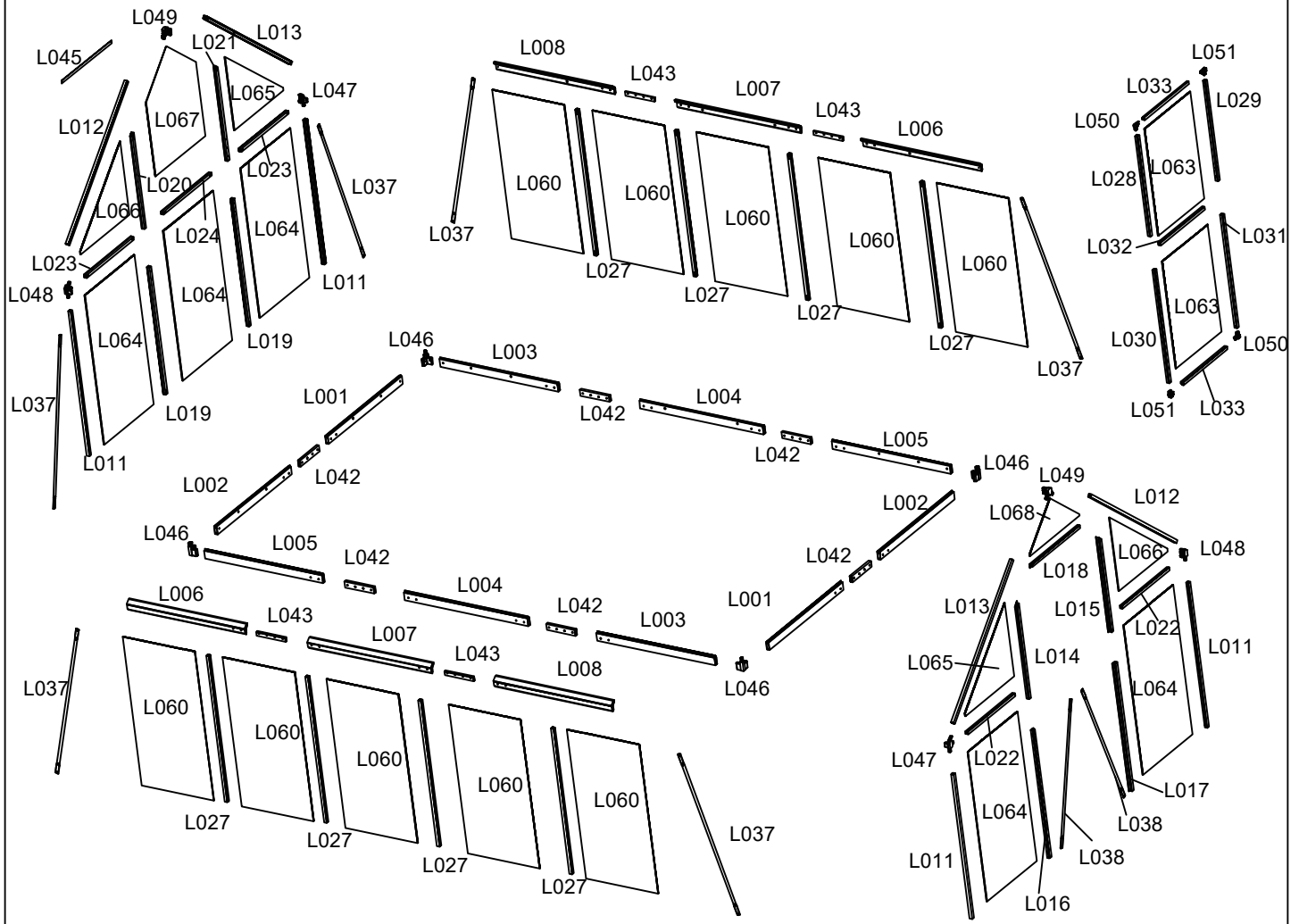
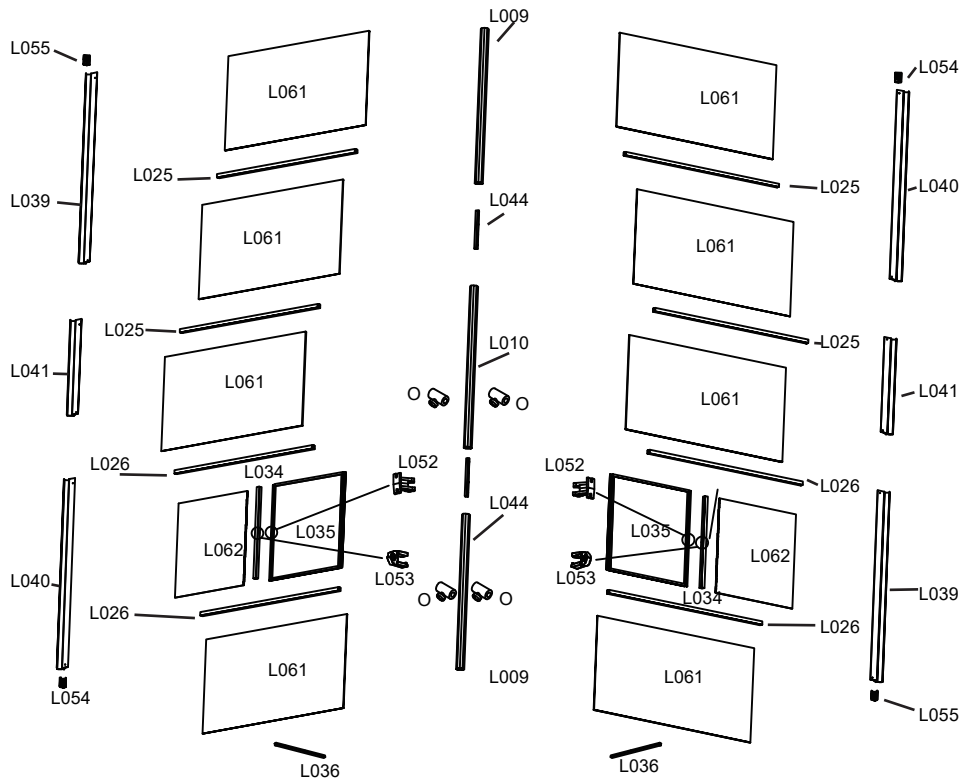



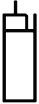



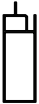



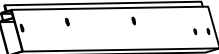

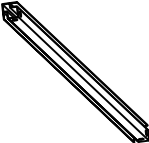



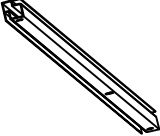

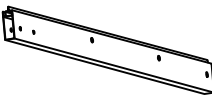

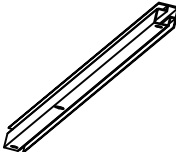
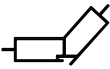
[www.alaulm.com](http://www.alaulm.com)

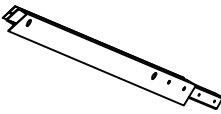













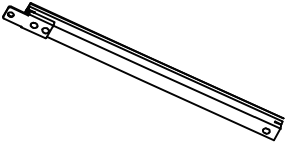

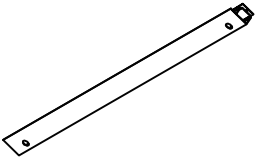

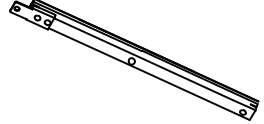







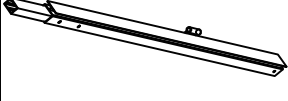

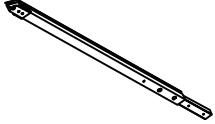

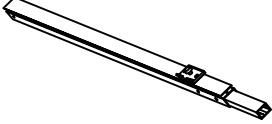

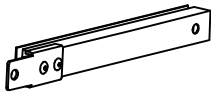
# The Roof of The 0610 PC Outdoor Greenhouse

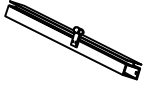

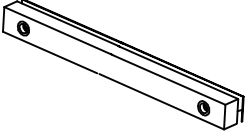



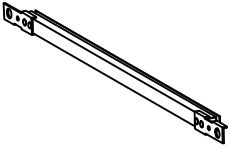





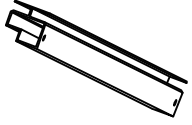

# PART LIST

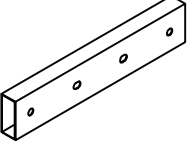
Label No.	Picture		Qty	Label No.	Picture		Qty
L001			2	L009			2
L002			2	L010			1
L003			2	L011			4
L004			2	L012			2
L005			2	L013			2
L006			2	L014			1
L007			2	L015			1
L008			2	L016			1

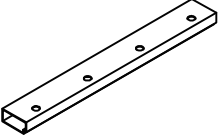
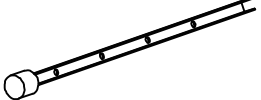
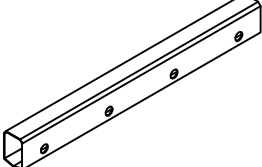

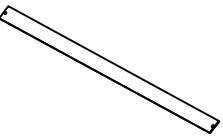
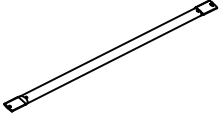

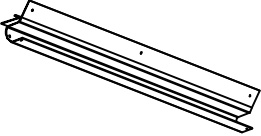
# PART LIST

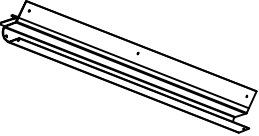
Label No.	Picture	Qty	Label No.	Picture	Qty
L017	 	1	L025	 	4
L018	 	1	L026	 	4
L019	 	2	L027	 	8
L020	 	1	L028	 	1
L021	 	1	L029	 	1
L022	 	2	L030	 	1
L023	 	2	L031	 	1
L024	 	1	L032	 	1



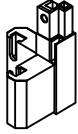
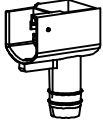
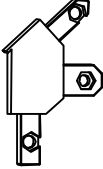
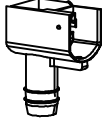
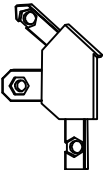

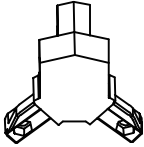
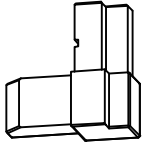
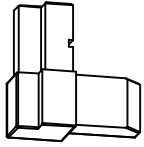
# PART LIST

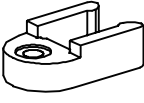
Label No.	Picture		Qty	Label No.	Picture		Qty
L033			2	L041			2
L034			2	L042			6
L035			2	L043			4
L036			2	L044			2
L037			6	L045			1
L038			2				
L039			2				
L040			2				

# PART LIST

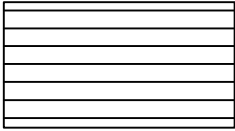
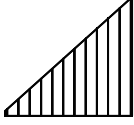
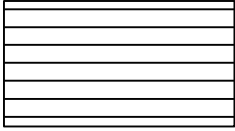
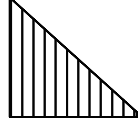

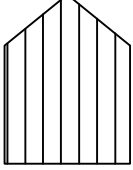
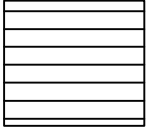
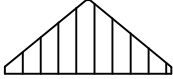
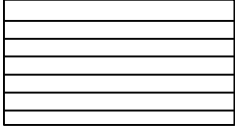
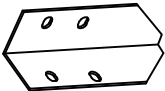

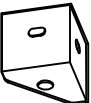
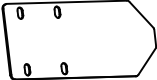



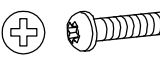
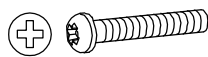
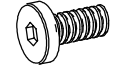
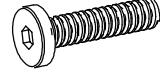
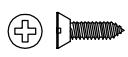
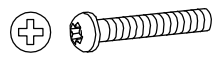
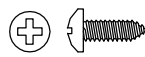

Label No.	Picture	Qty	Label No.	Picture	Qty
L046		4	L054		2
L047		2	L055		2
L048		2	L069	 3M rubber strip	4
L049		2			
L050		2			
L051		2			
L052		2			
L053		2			

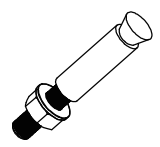
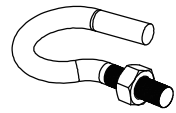
# PART LIST

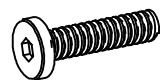
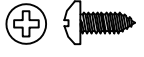
Label No.	Picture	Qty	Label No.	Picture	Qty
L060	 1072*549MM	10	L065		2
L061	 1140*549MM	8	L066		2
L062	 556*549MM	2	L067		1
L063	 770*527MM	2	L068		1
L064	 1077*574MM	5			
L056		4	L058		2
L057		4	L059		2

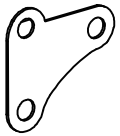
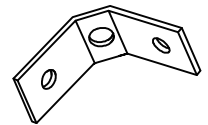

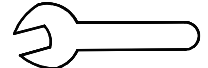
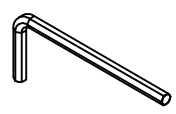

# PART LIST

## Screw Set

Screw Set			
<p><b>A</b></p>  <p>M4*20</p>	<p><b>B</b></p>  <p>M4*32</p>	<p><b>C</b></p>  <p>M6*12</p>	<p><b>D</b></p>  <p>M6*25</p>
2PCS	2PCS	91PCS	24PCS
<p><b>E</b></p>  <p>M3*10</p>	<p><b>F</b></p>  <p>M6*25</p>	<p><b>G</b></p>  <p>M4*12</p>	<p><b>H</b></p>  <p>M4</p>
4PCS	10PCS	38PCS	2PCS
<p><b>I</b></p>  <p>M6</p>	<p><b>J</b></p>  <p>M6*50</p>	<p><b>K</b></p> 	<p><b>L</b></p>  <p>M3*5</p>
50PCS	6PCS	1PC	8PCS
<p><b>M</b></p>  <p>M6*20</p>	<p><b>N</b></p>  <p>M4*8</p>	<p><b>O</b></p> 	<p><b>P</b></p> 
16PCS	6PCS	4PCS	2PCS
<p><b>Q</b></p> 	<p><b>R</b></p> 	<p><b>S</b></p> 	<p><b>T</b></p> 
2PCS	4PCS	1PC	1PC
<p><b>U</b></p> 	<p><b>V</b></p> 		
1PC	1PC		

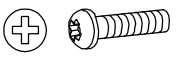
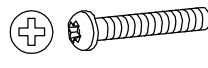
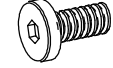
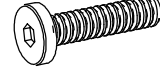
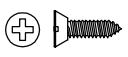
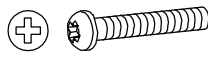
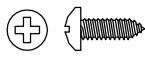
# PART LIST

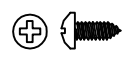
## Extra (Screw Set)

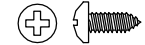
Extra (Screw Set)			
<p>(A)</p>  <p>M4*20</p>	<p>(B)</p>  <p>M4*32</p>	<p>(C)</p>  <p>M6*12</p>	<p>(D)</p>  <p>M6*25</p>
1PC	1PC	2PCS	1PC
<p>(E)</p>  <p>M3*10</p>	<p>(F)</p>  <p>M6*25</p>	<p>(G)</p>  <p>M4*12</p>	<p>(H)</p>  <p>M4</p>
1PC	1PC	3PCS	1PC
<p>(I)</p>  <p>M6</p>	<p>(L)</p>  <p>M3*5</p>	<p>(M)</p>  <p>M6*20</p>	<p>(N)</p>  <p>M4*8</p>
1PC	1PC	2PCS	1PC

# Installation steps

## STEP 01

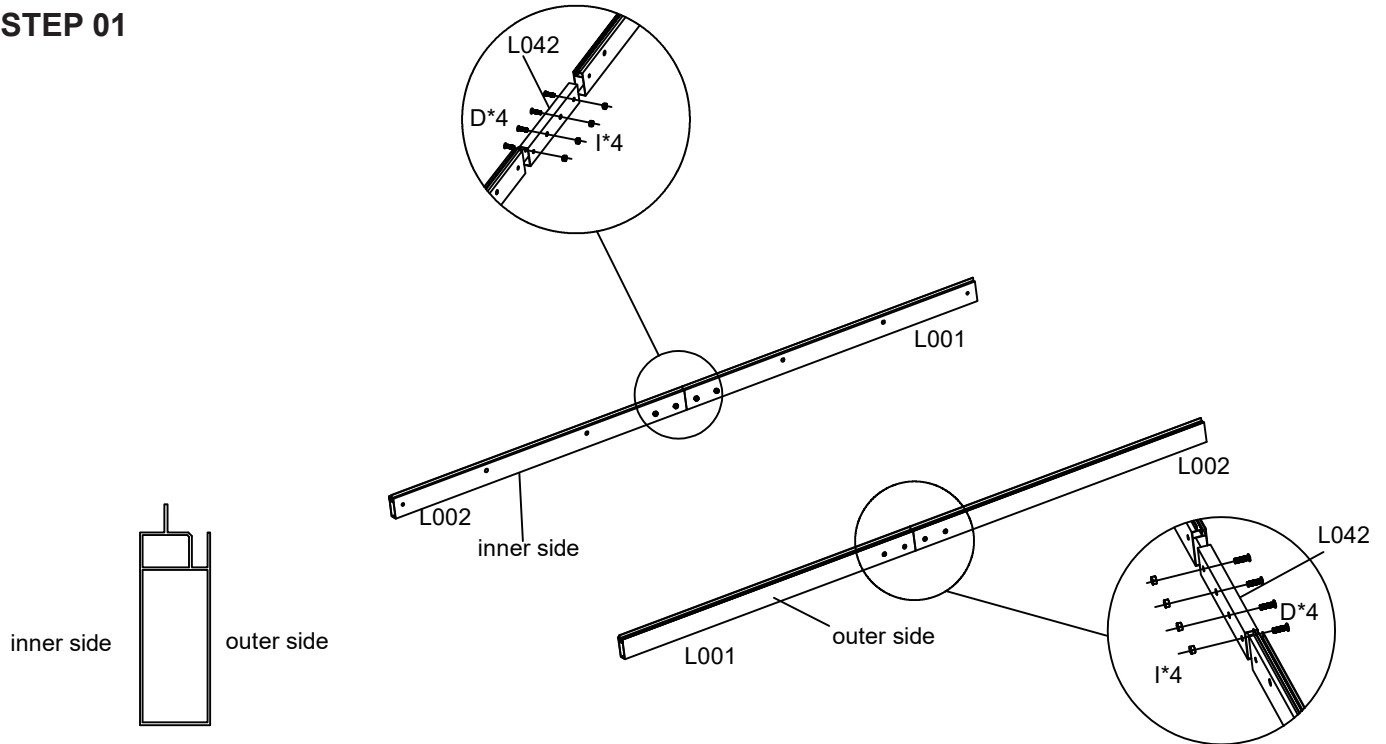

<p>L001*2</p>	<p>L002*2</p>	<p>L042*2</p>	<p>D*8</p> <p>M6*25</p>	<p>I*8</p> <p>M6</p>
---------------	---------------	---------------	-------------------------	----------------------

## STEP 02

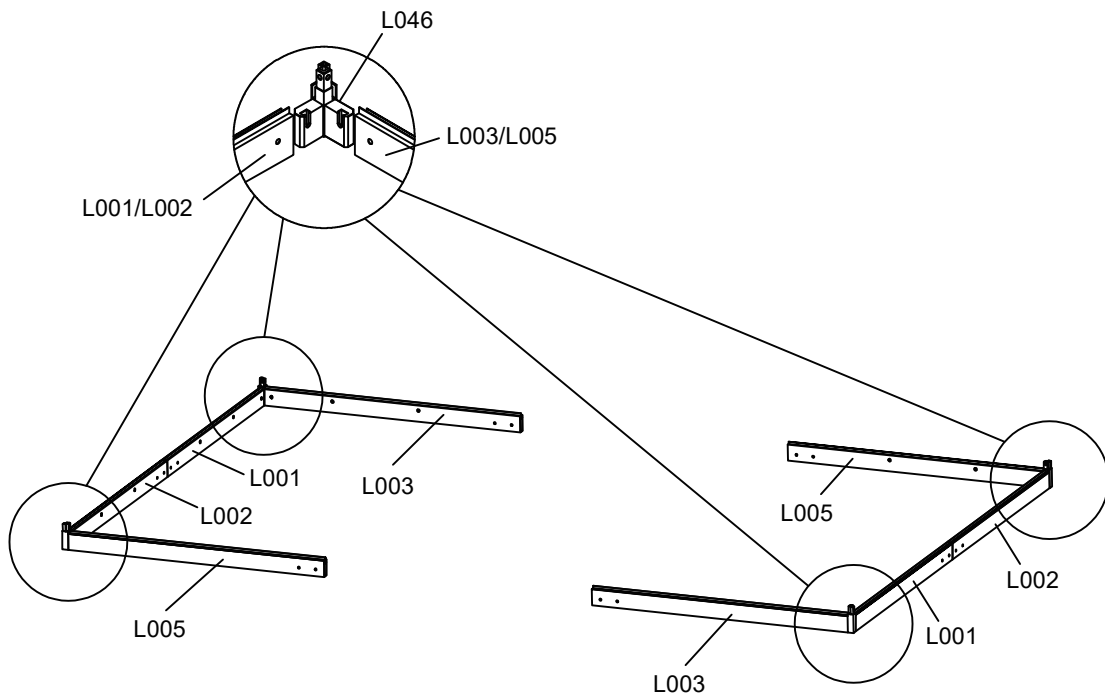

<p>L003*2</p>	<p>L005*2</p>	<p>L046*4</p>
---------------	---------------	---------------

# Installation steps

## STEP 03

Assembly method of concrete floor

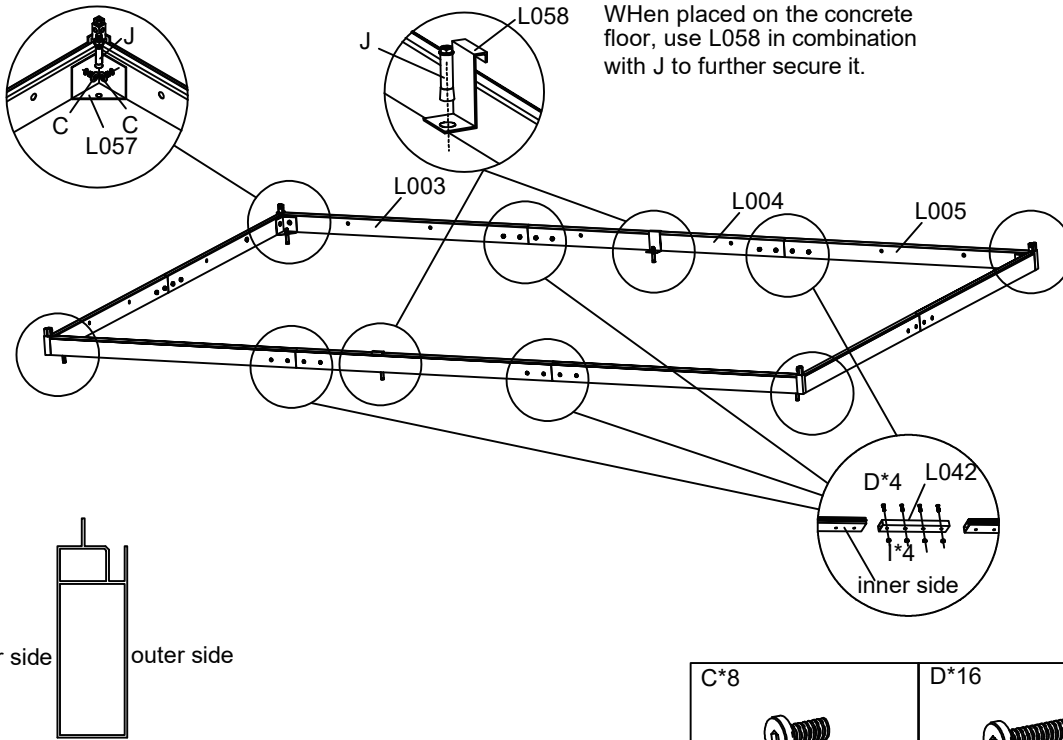

When placed on the concrete floor, use L058 in combination with J to further secure it.

- L004\*2
- L042\*4
- L057\*4
- L058\*2
- J\*6

- |            |             |          |
|------------|-------------|----------|
| C*8  M6*12 | D*16  M6*25 | I*16  M6 |
|------------|-------------|----------|

## STEP 04

Assembly method for lawn ground

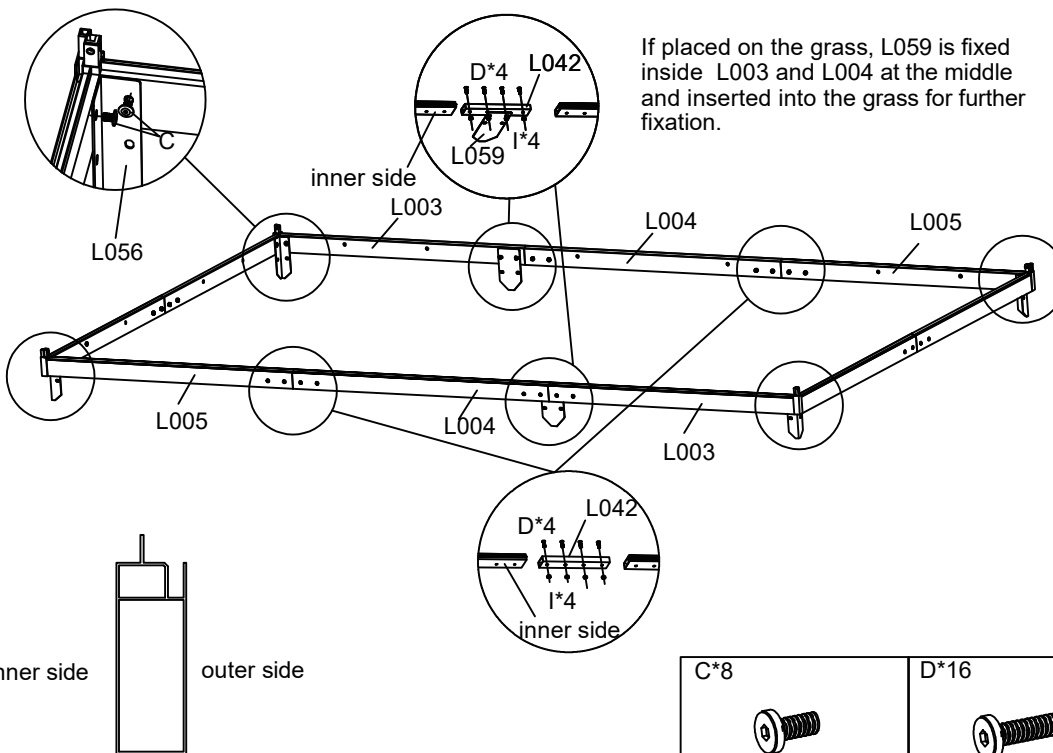

If placed on the grass, L059 is fixed inside L003 and L004 at the middle and inserted into the grass for further fixation.

- L004\*2
- L042\*4
- L056\*4
- L059\*2

- |            |             |          |
|------------|-------------|----------|
| C*8  M6*12 | D*16  M6*25 | I*16  M6 |
|------------|-------------|----------|

# Installation steps

## STEP 05

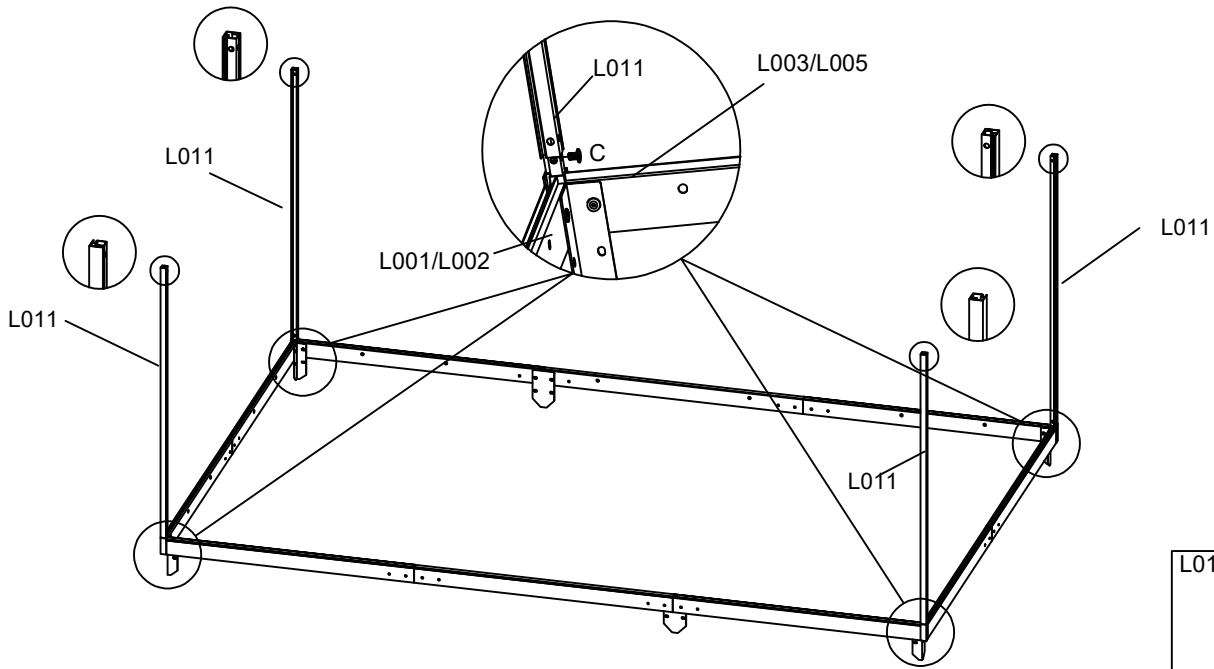

Just choose one hole from Part L011 or L046 to assembly and then tighten the screw.

L011*4	
C*4	
	M6*12

## STEP 06

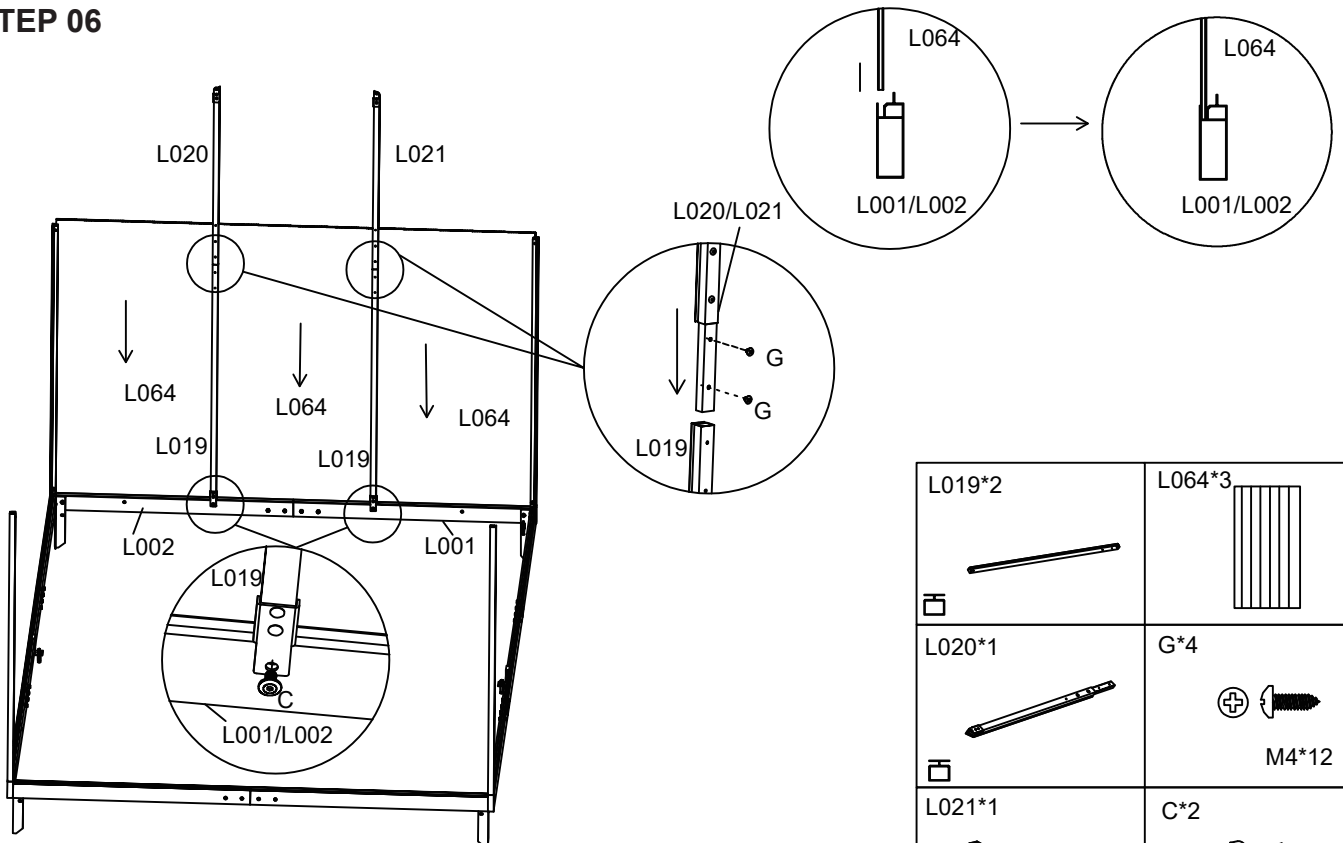



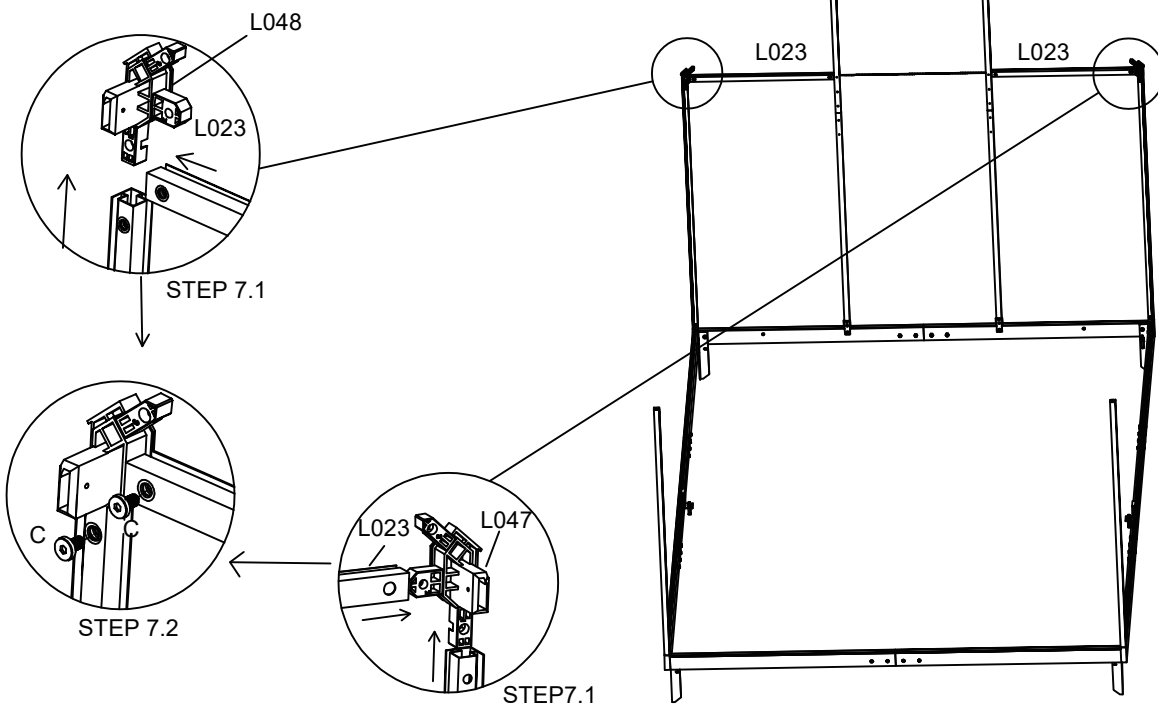

L019*2		L064*3	
L020*1		G*4	
	M4*12		
L021*1		C*2	
			M6*12

# Installation steps



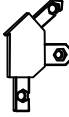

## STEP 07

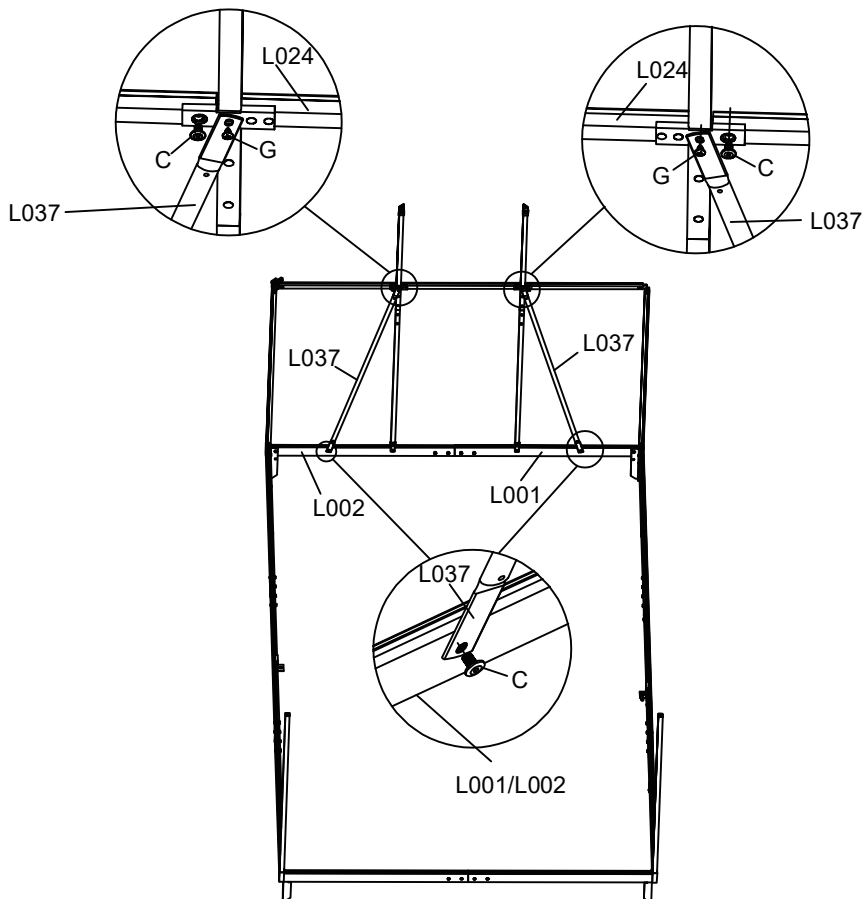

L023*2 	C*4  M6*12	L047*1 	L048*1 
---	---	--	--

## STEP 08



L024*1 
L037*2 
C*4  M6*12
G*2  M4*12

# Installation steps

## STEP 9

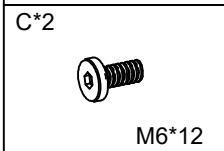
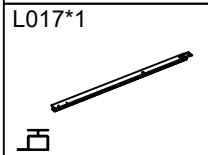
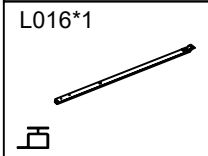
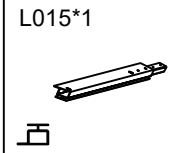
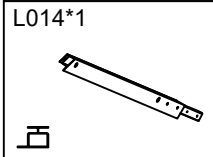
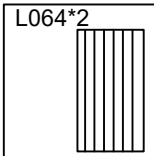
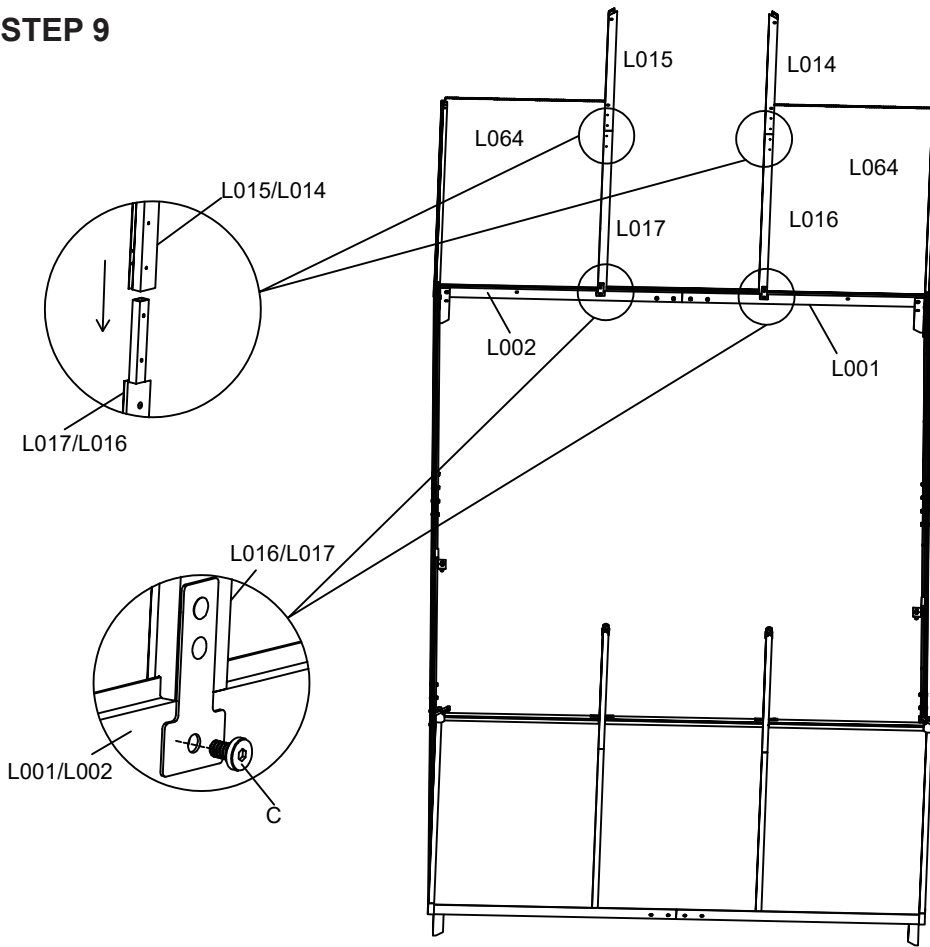

## STEP 10

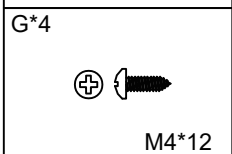
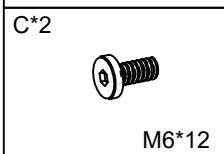
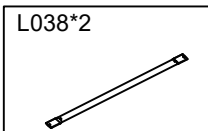
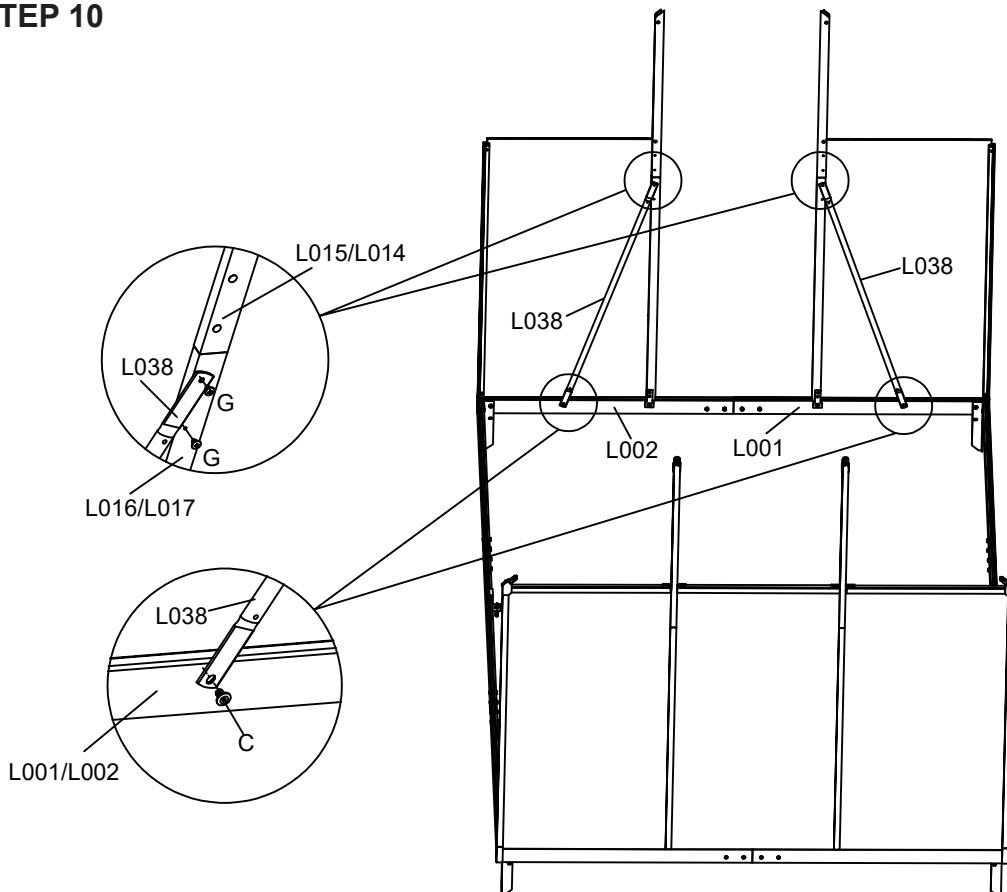

# Installation steps

STEP 11

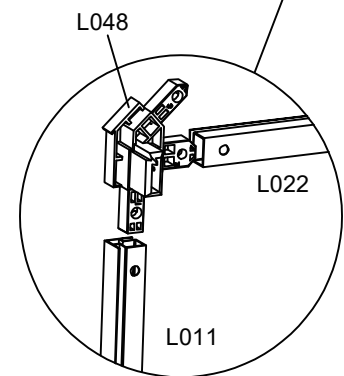
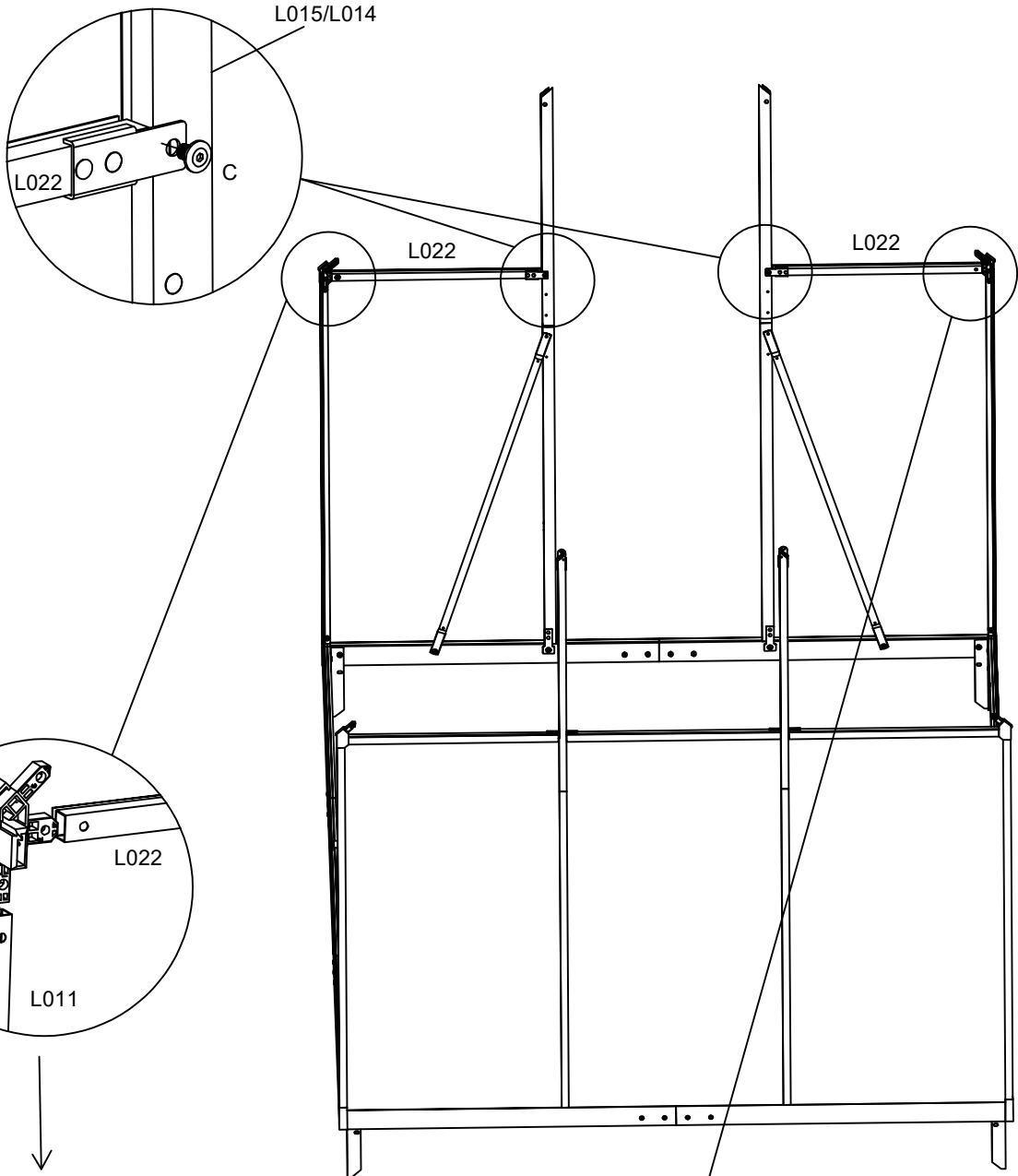

STEP 10.1

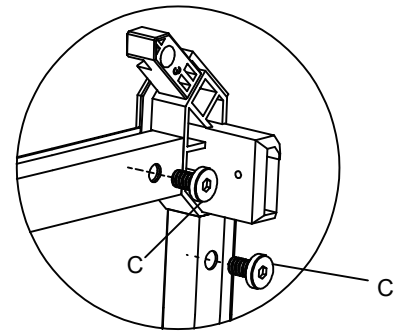

STEP 11.2

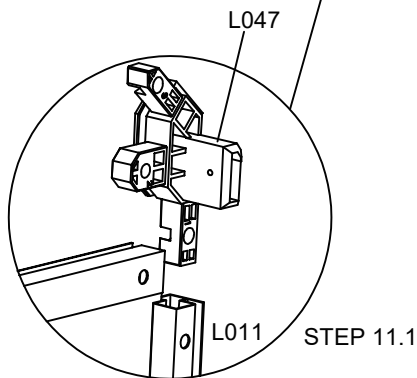

STEP 11.1

<p>L047*1</p>	<p>L048*1</p>	<p>L022*2</p>	<p>C*6</p> <p>M6*12</p>
---------------	---------------	---------------	-------------------------

# Installation steps

## STEP 12

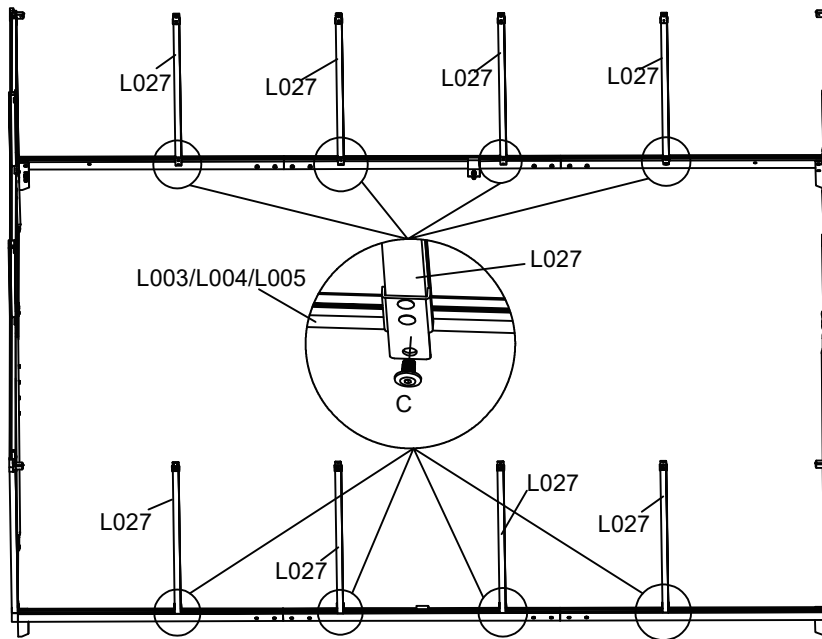

L027\*8



C\*8



M6\*12

## STEP 13

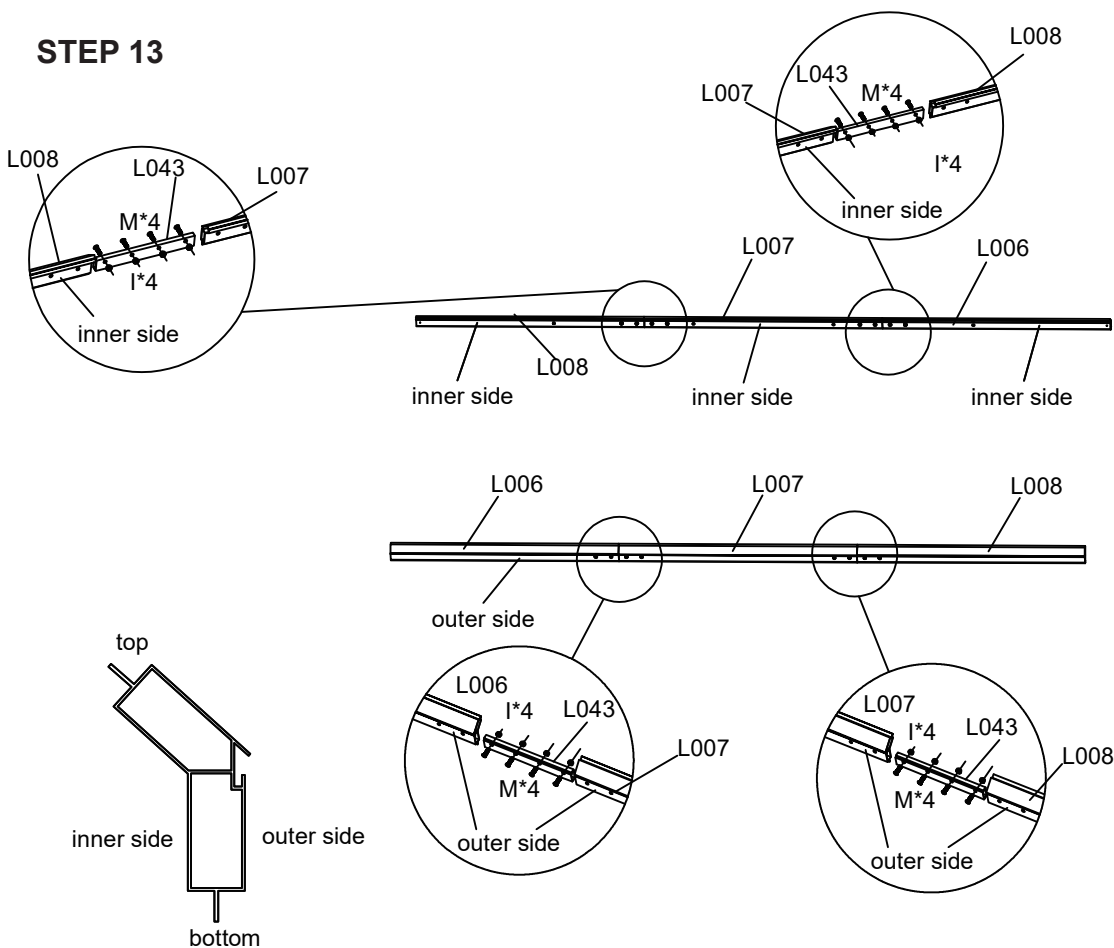

L043\*4

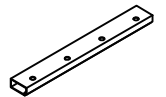

L008\*2

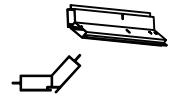

L007\*2

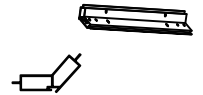

L006\*2

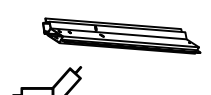

M\*16



M6\*20

I\*16



M6

# Installation steps

## STEP 14

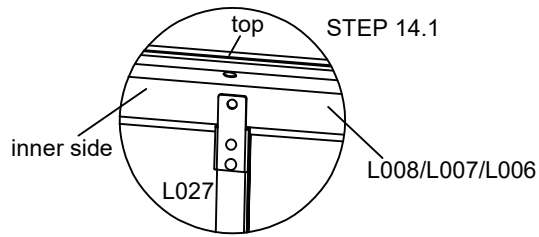

L006, L007, L008, bottom and L027 connection. After placing the L006, L007, L008, align it with the 'L027' hole.

### STEP 14.2

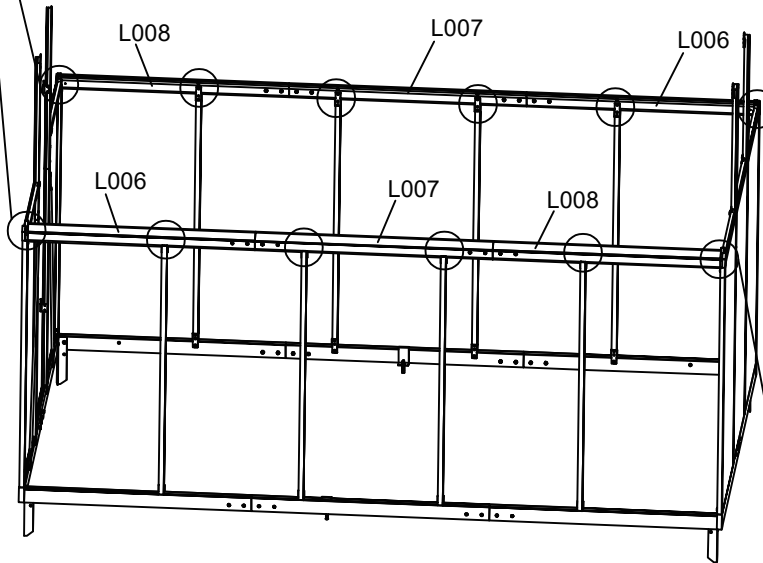
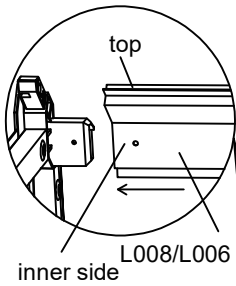

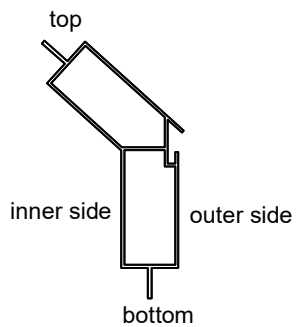
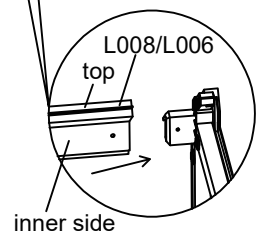

### STEP 14.2

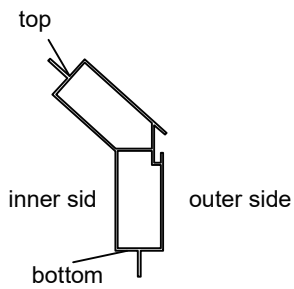
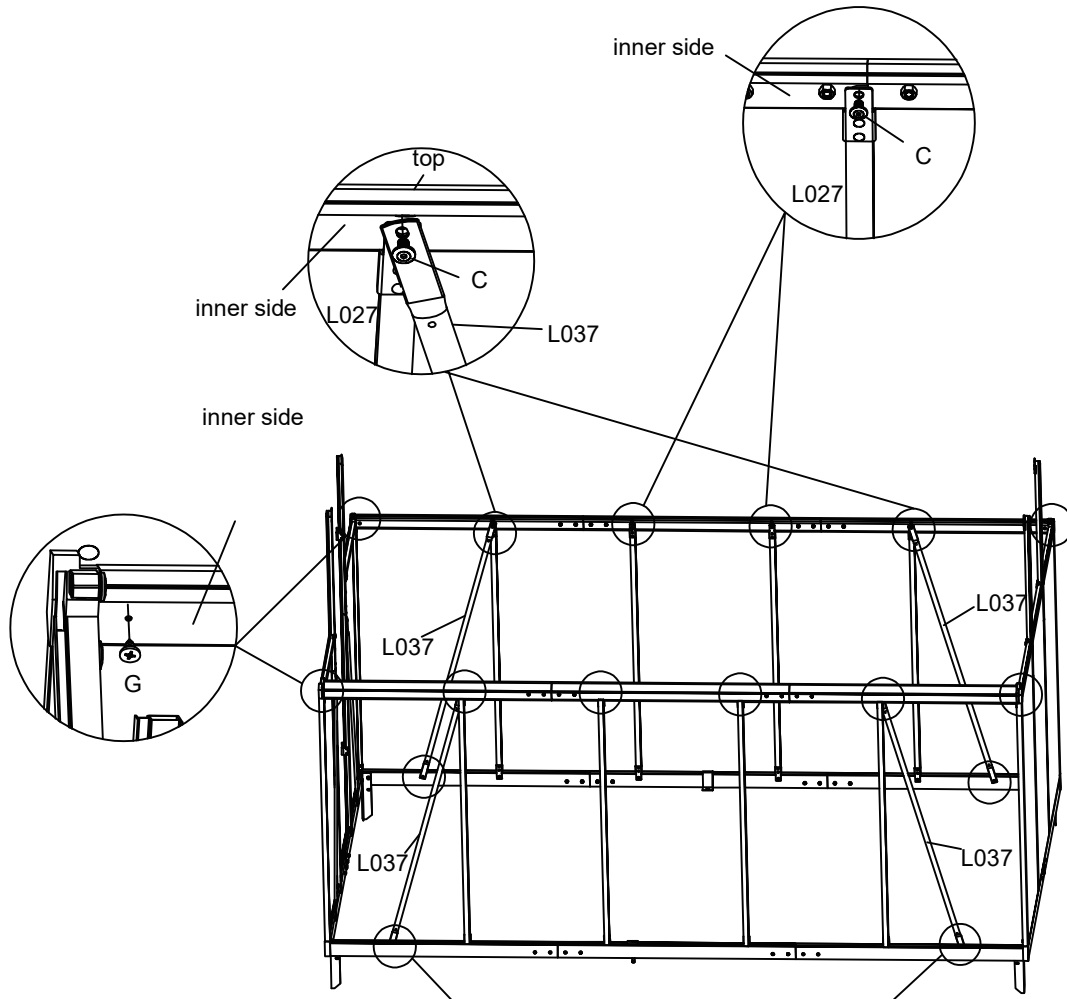

# Installation steps

## STEP 15

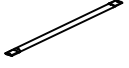

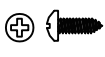
L037*4	
C*12	 M6*12
G*4	 M4*12

# Installation steps

## STEP 16

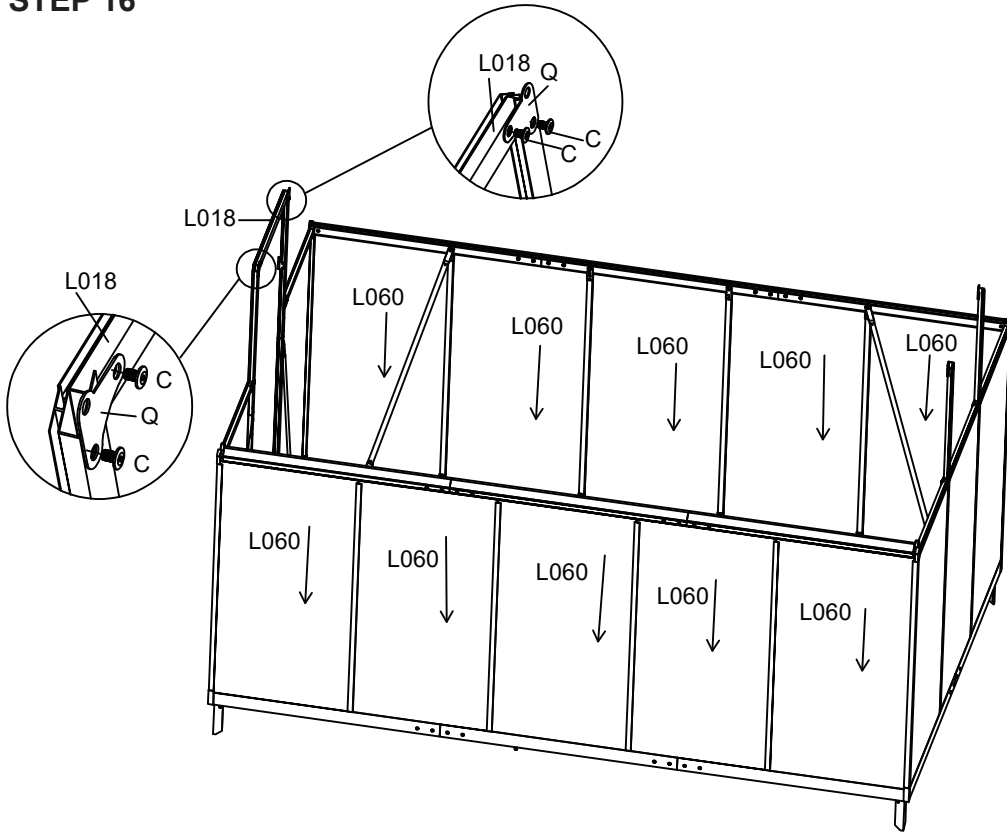

L060*10	
L018*1	
C*4	
M6*12	
Q*2	

## STEP 17

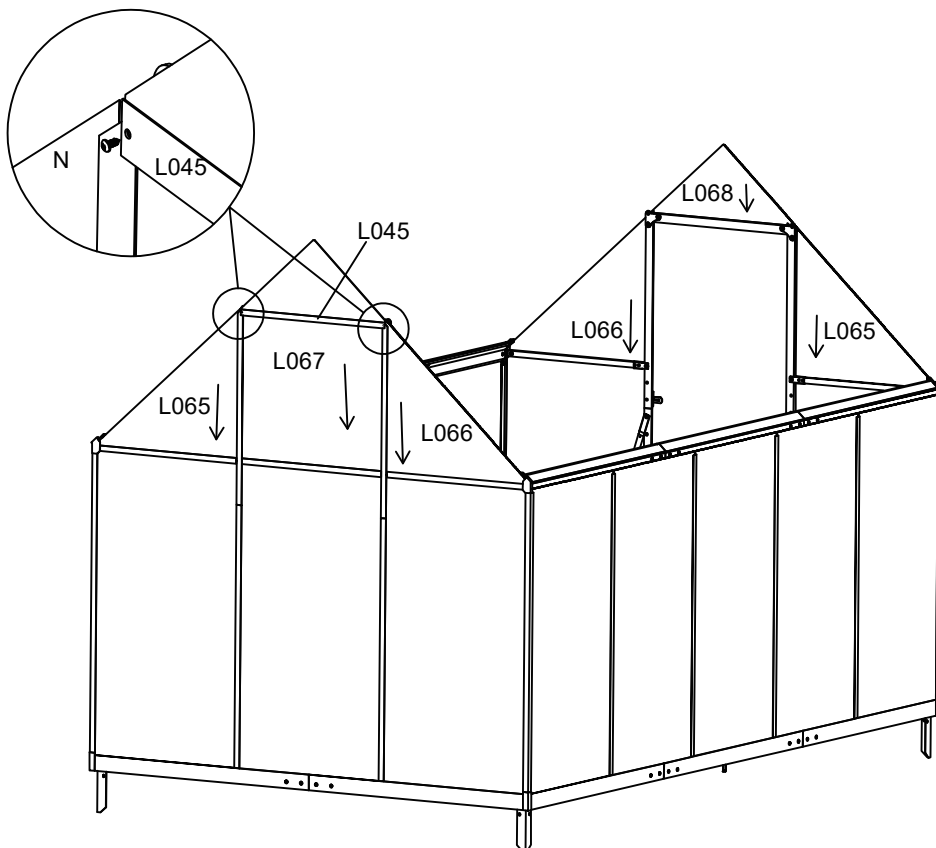



L065*2	
L066*2	
L067*1	
L068*1	
L045*1	
N*2	
M4*8	

# Installation steps

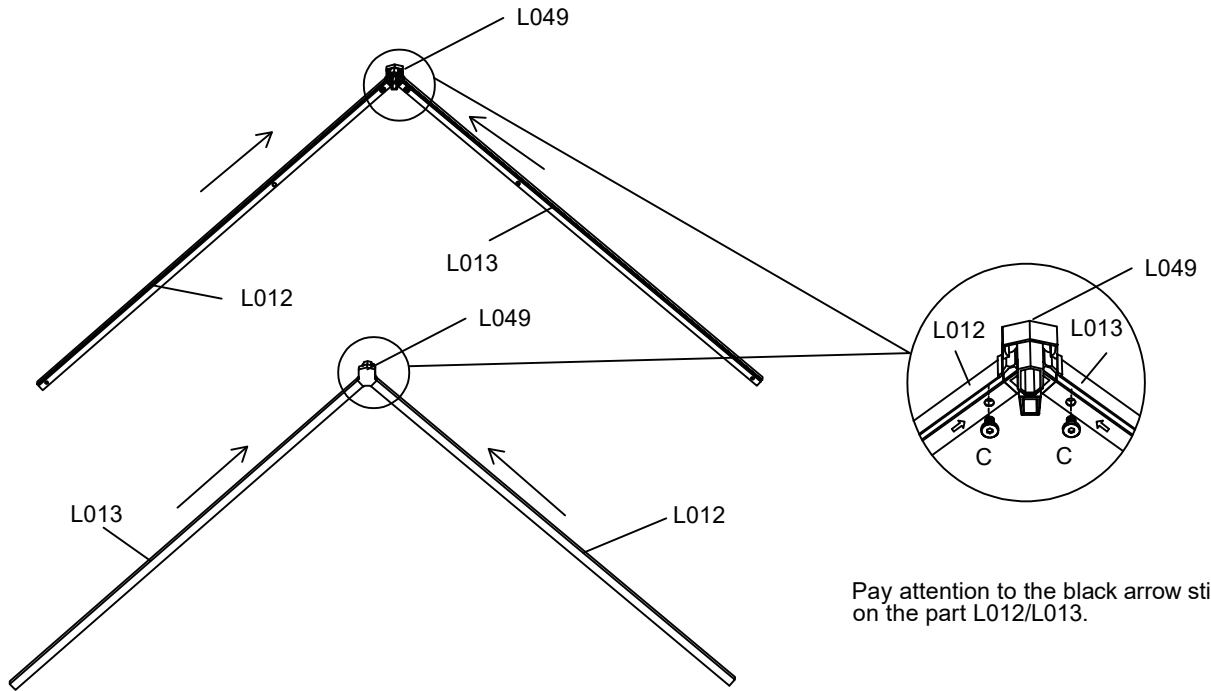
## STEP 18

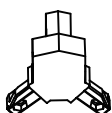

L012*2 	L013*2 	C*4  M6*12	L049*2 
--	--	---	--

## STEP 19

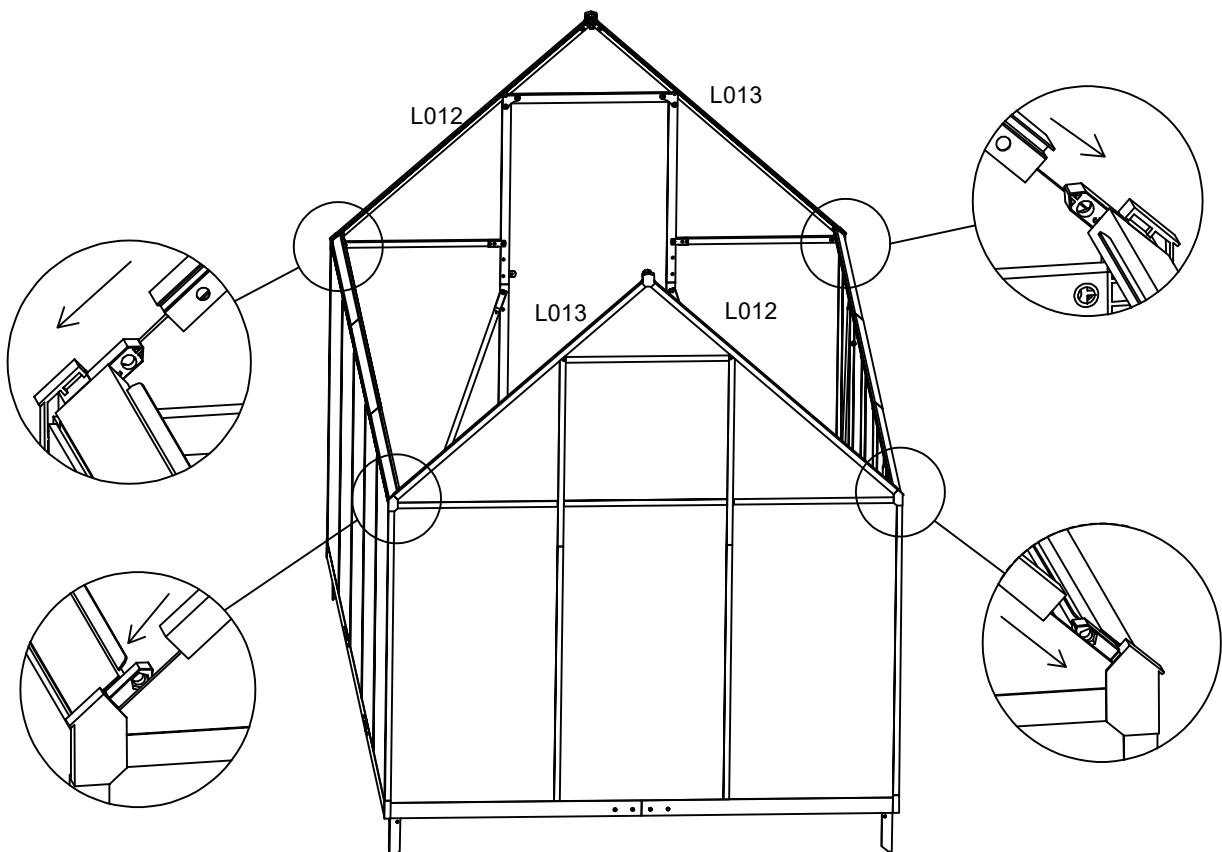

# Installation steps

## STEP 20

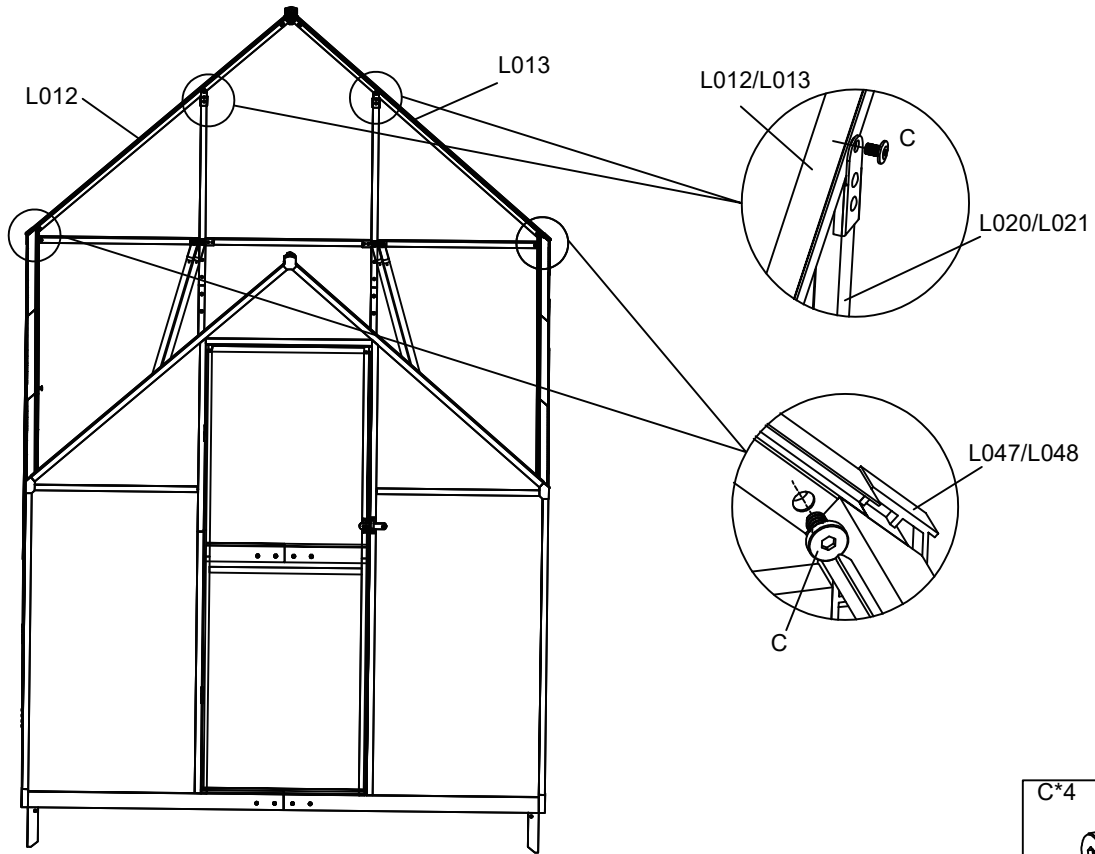

C\*4



M6\*12

## STEP 21

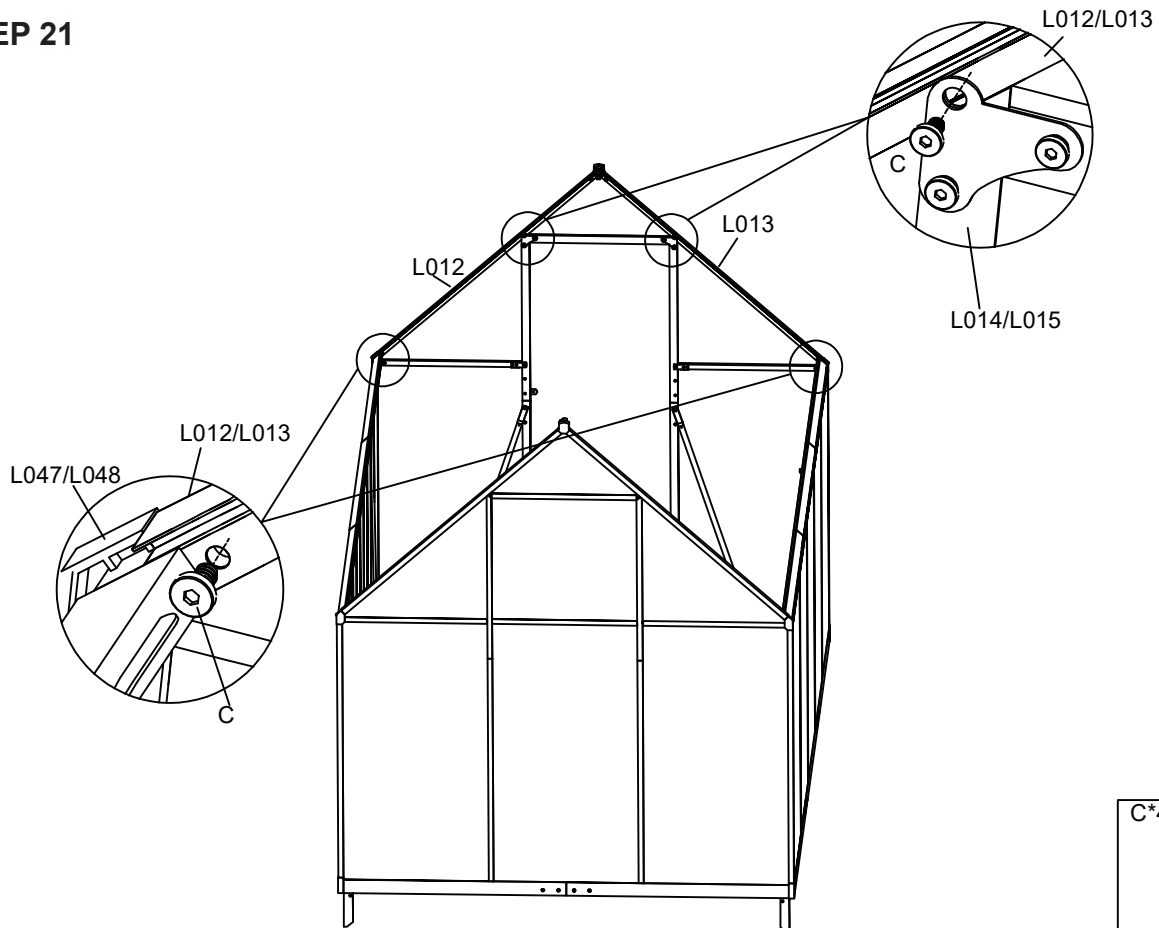

C\*4





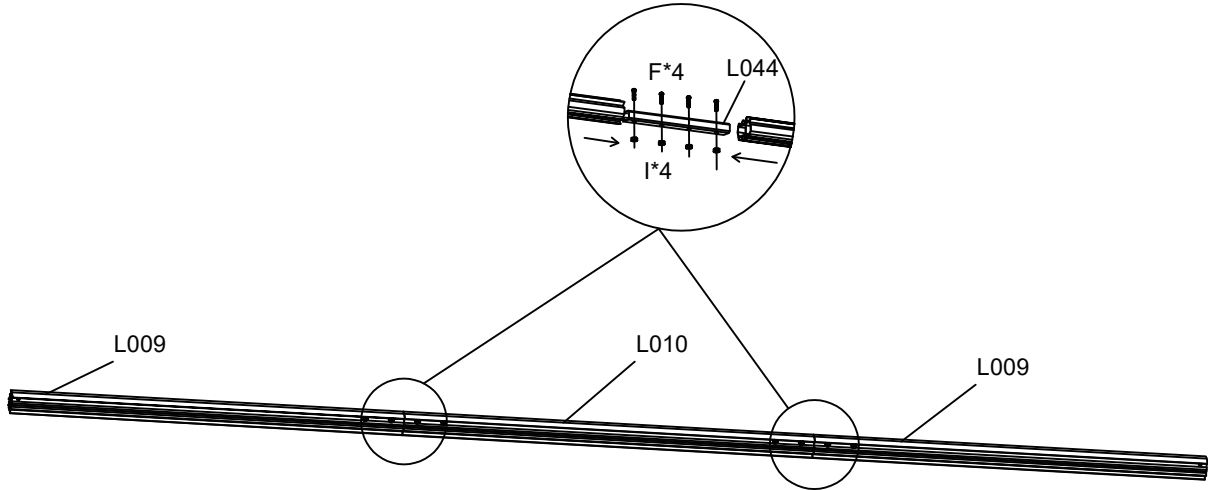

M6\*12

# Installation steps

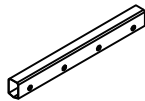

## STEP 22



L044*2 	L009*2 	L010*1 	F*8  M6*25	I*8  M6
---	---	--	---	--

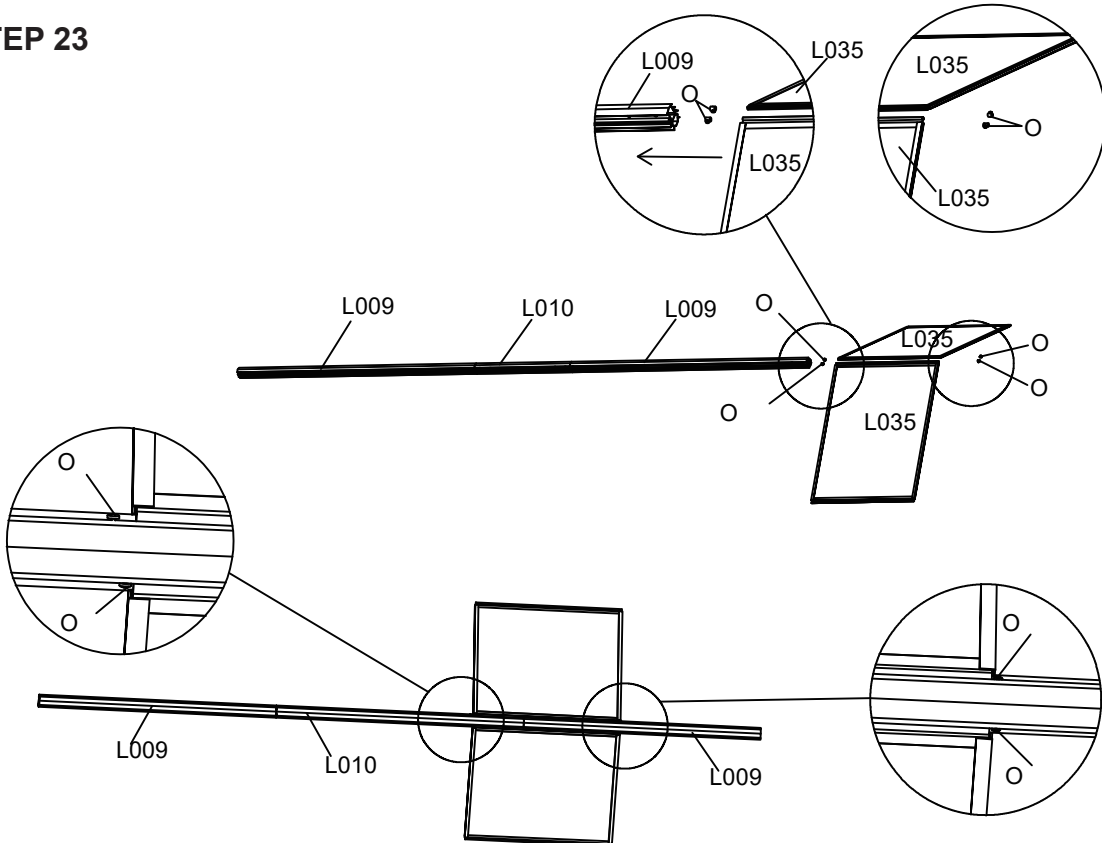

## STEP 23

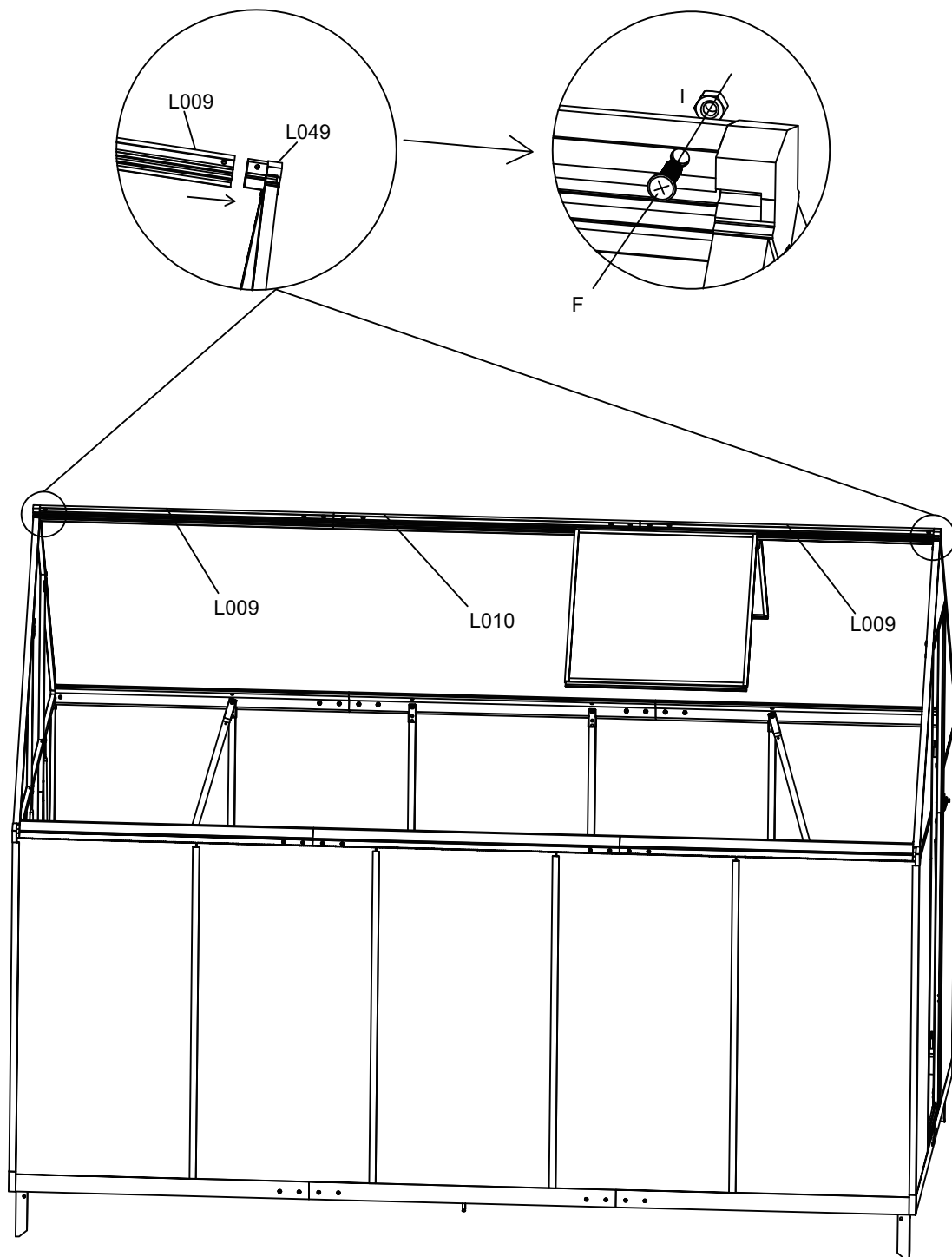

L035*2 
O*4 

## STEP 24



I*2	F*2
	
M6	M6*25

## STEP 25

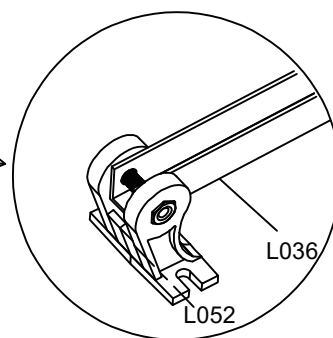
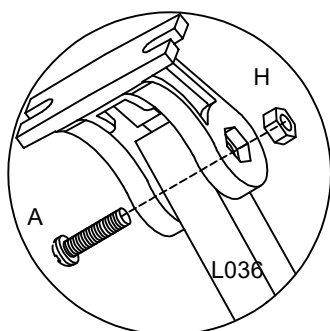
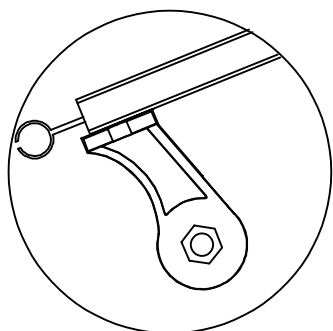
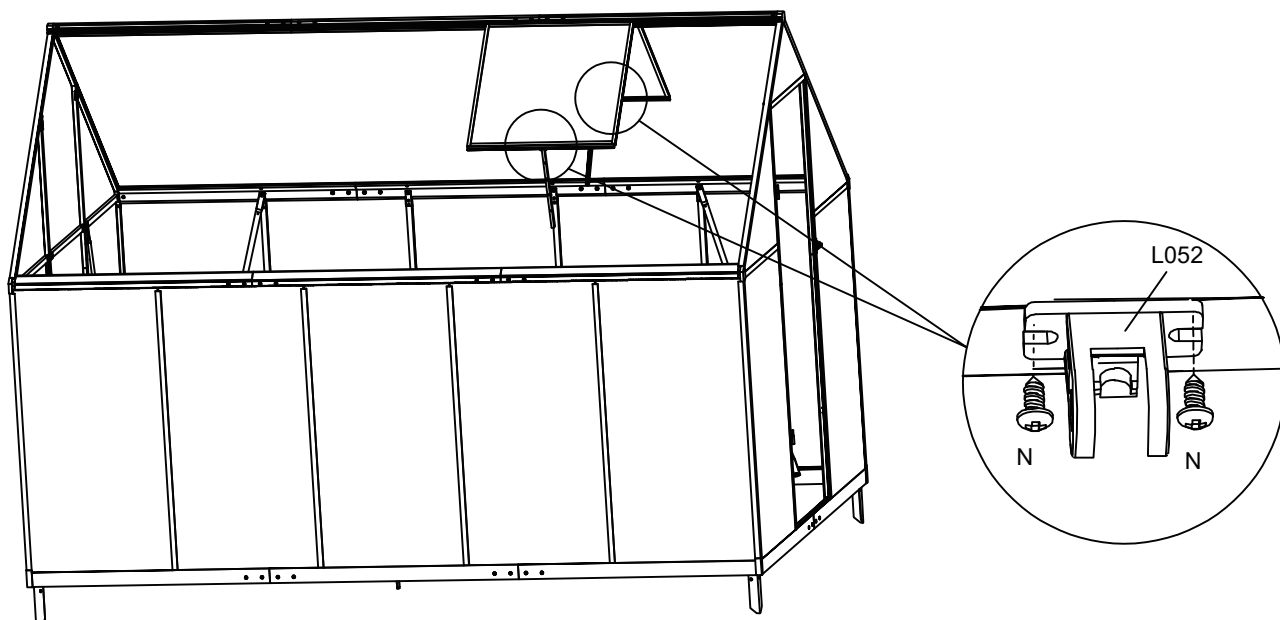

The side with the hole is facing downwards  
Please note the L052 orientation.

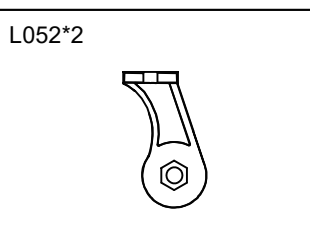
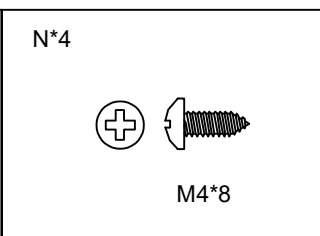
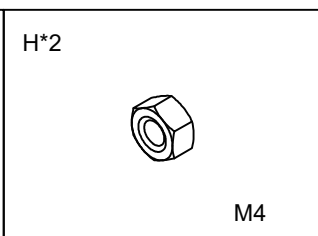
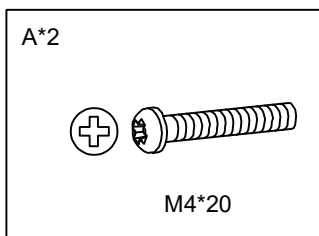
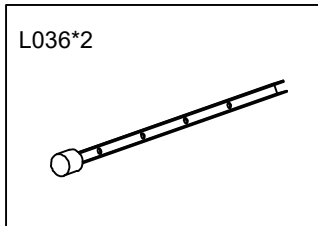



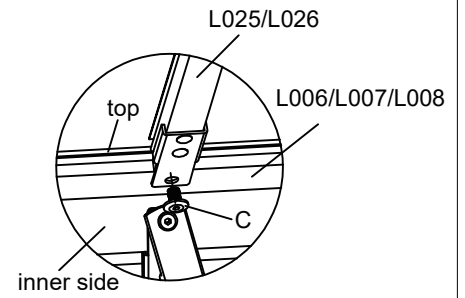
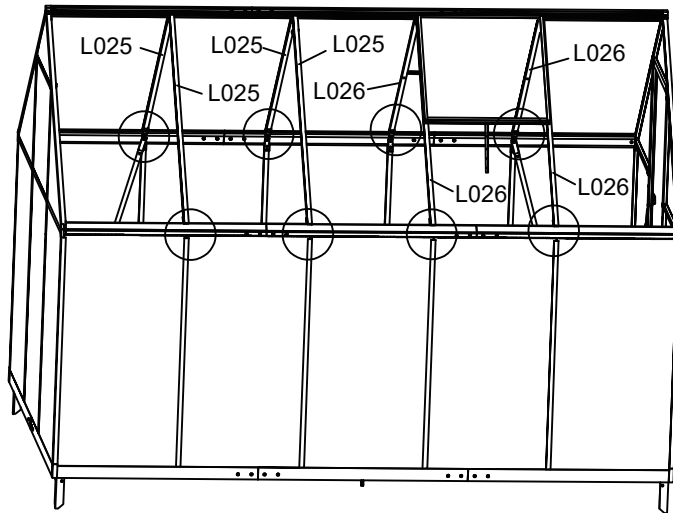

# Installation steps

## STEP 26

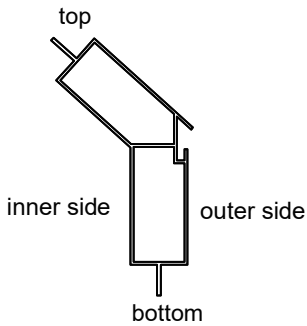



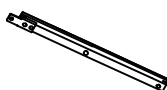

L026 is the support tube for L035.  
Be careful not to install it in the wrong position.

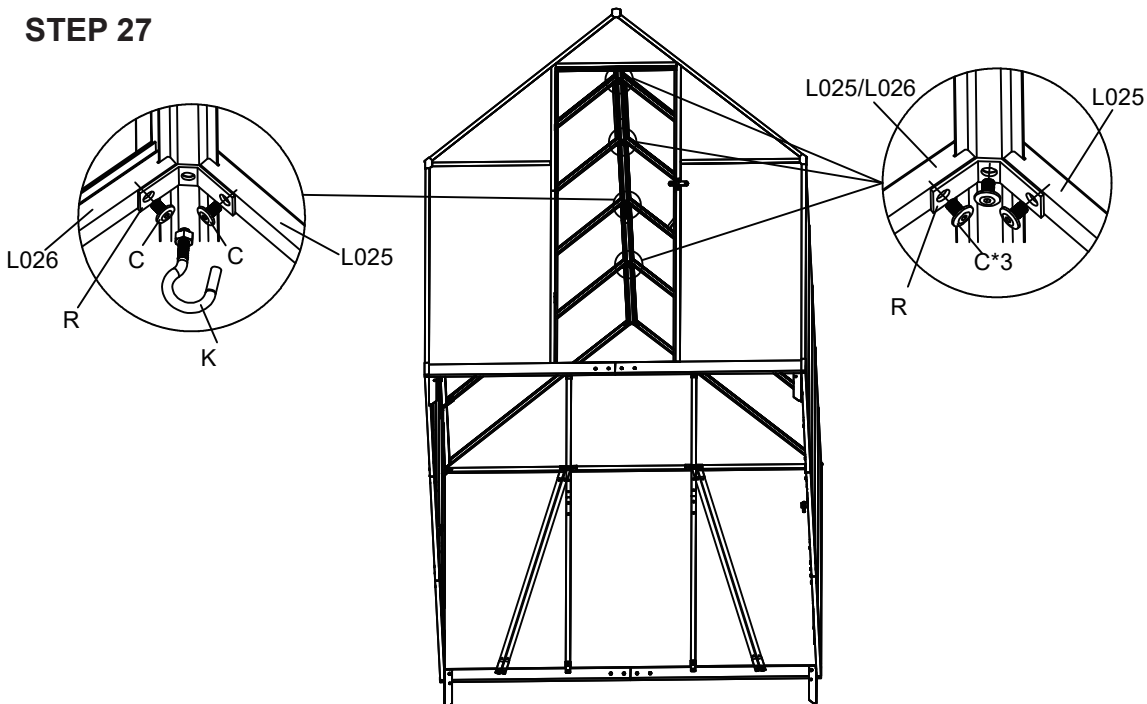

L025*4 	L026*4 	C*8  M6*12
--	---	---

## STEP 27



R*4 	C*11  M6*12	K*1 
---	--	--

# Installation steps





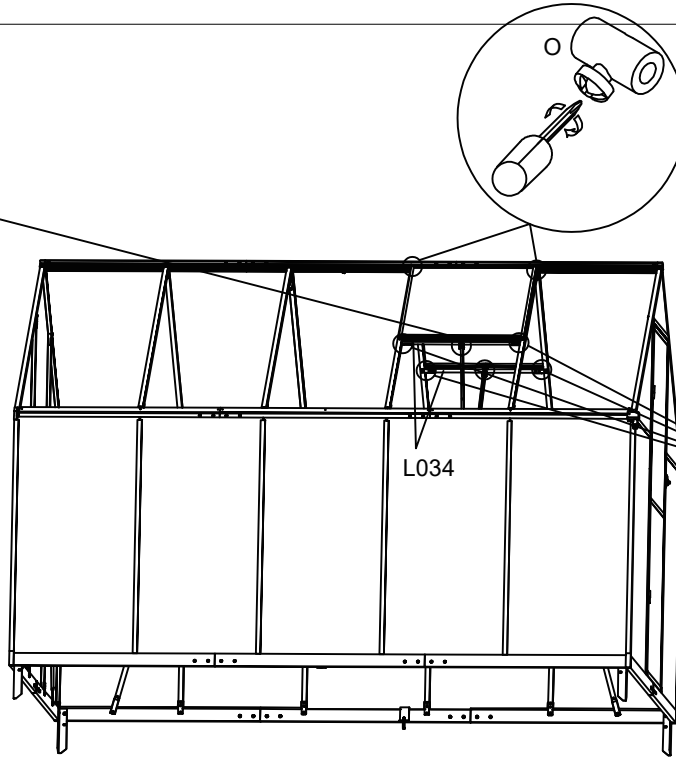
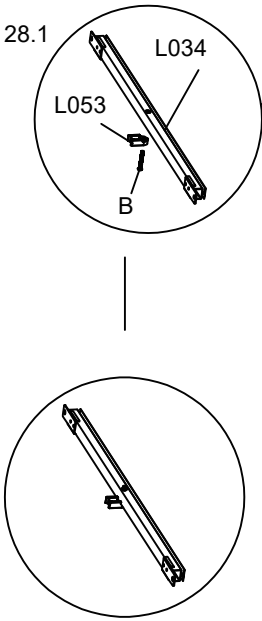

## STEP 28

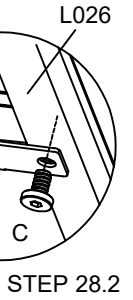
STEP 28.1





After adjusting the position of window component L035, tighten O.

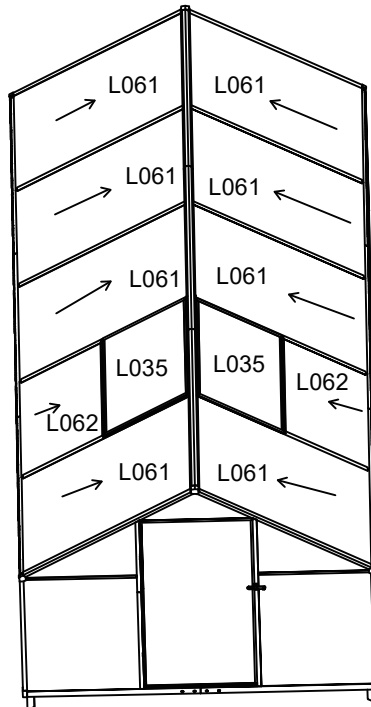

L034*2 	L053*2 	B*2 	C*4 
		 M4*32	 M6*12

## STEP 29

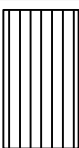

L061*8 	L062*2 
---	---

# Installation steps

## STEP 30

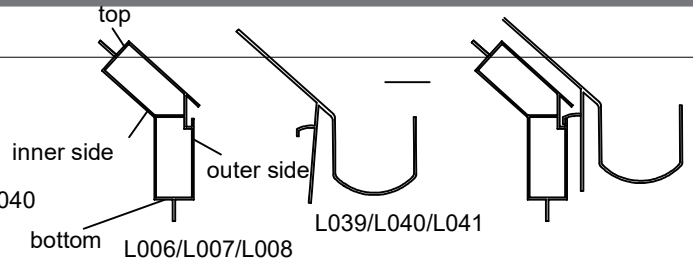
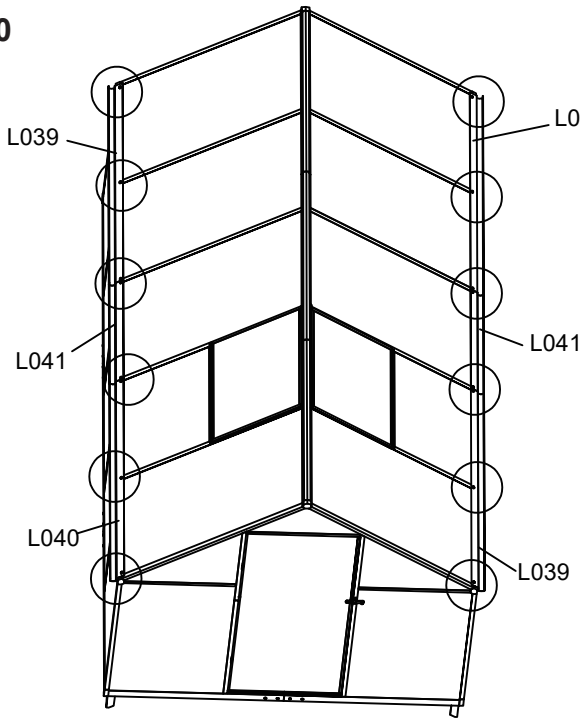

When assembling L039/L040/L041, it is necessary to press firmly to ensure that L039/L040/L041 is hung on the slot of L006/L007/L008 before tightening screw G.

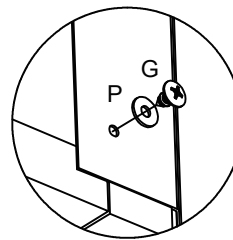
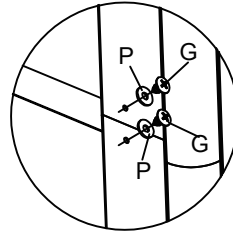

L039*2 	L040*2 	L041*2 	P*2 	G*16 
				M4*12 

## STEP 31

Align the 3M rubber strip with the gap between L039, L040 and L041, and then stick them together.

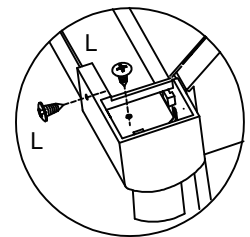
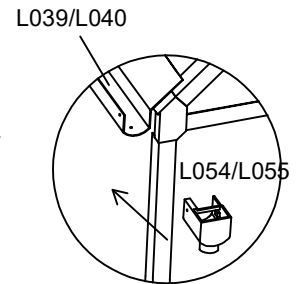
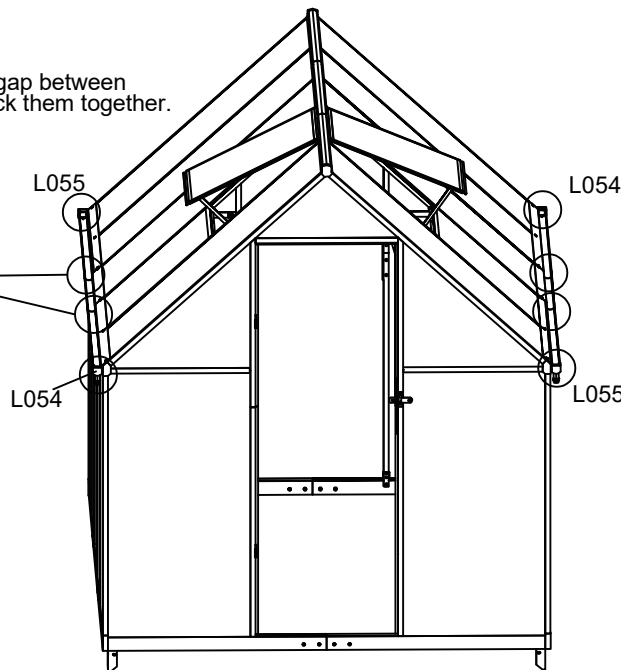
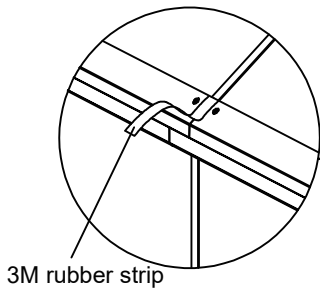

4PCS 	L054*2 	L055*2 	L*8 
			M3*5 

# Installation steps

## STEP 32

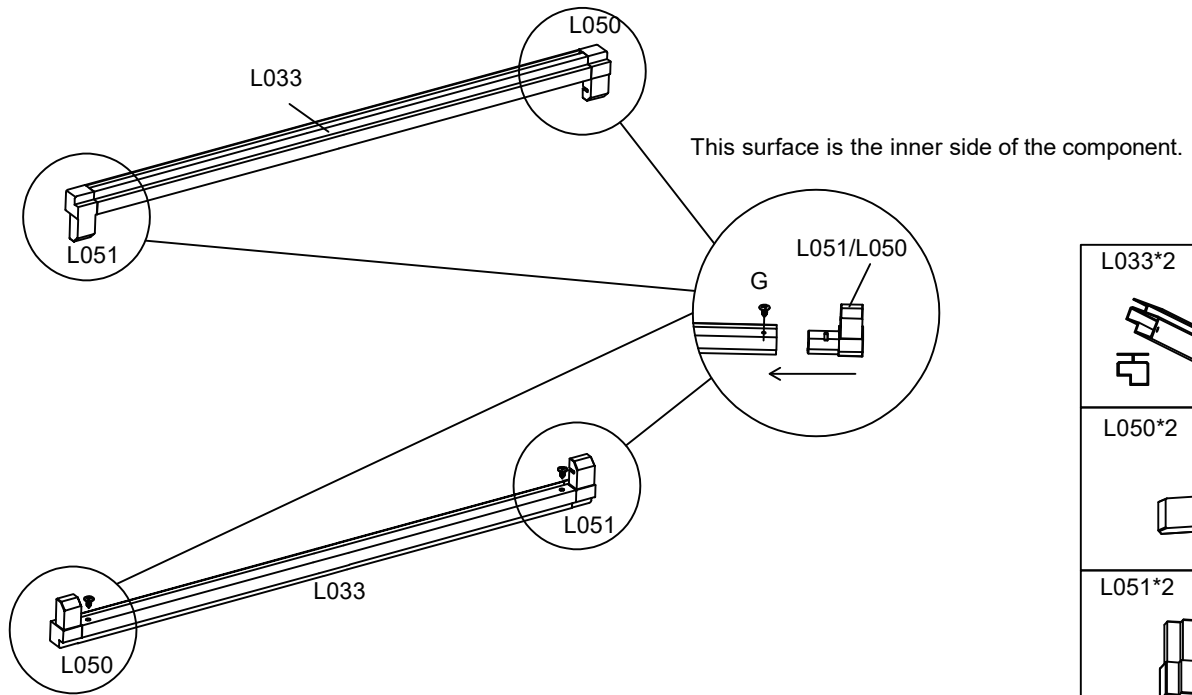

L033\*2

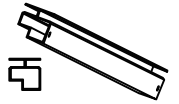

L050\*2



L051\*2



G\*4



M4\*12

## STEP 33

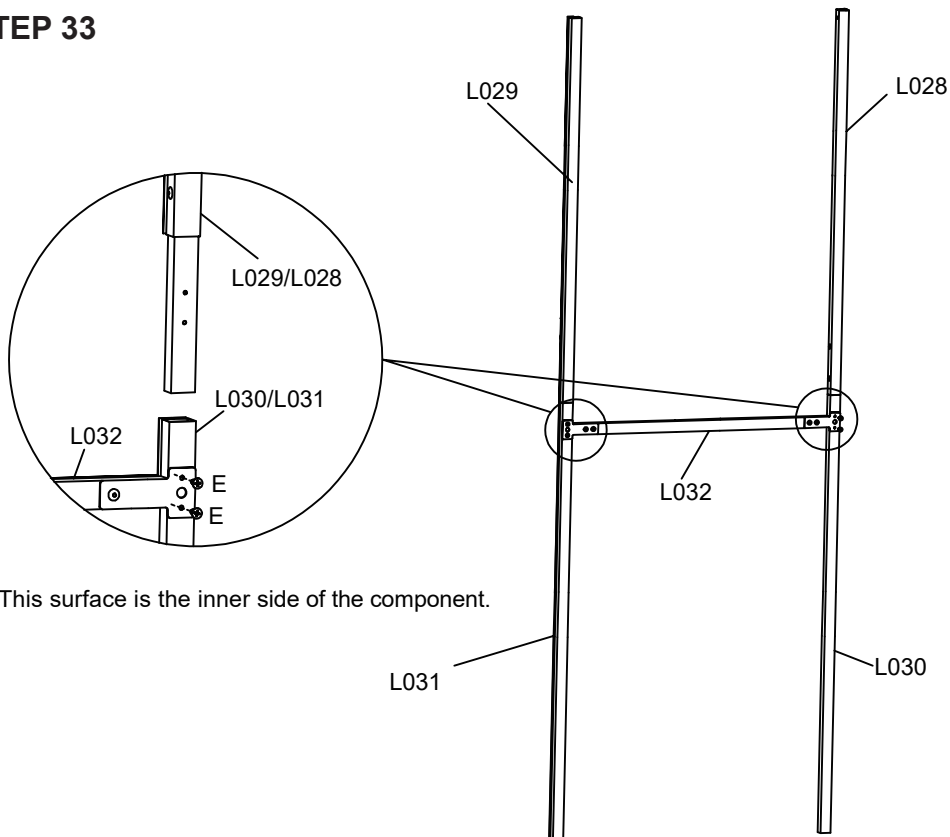

L028\*1

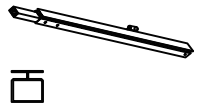

L029\*1

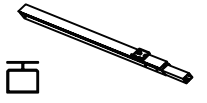

L030\*1



L031\*1



L032\*1



E\*4



M3\*10

# Installation steps

## STEP 34

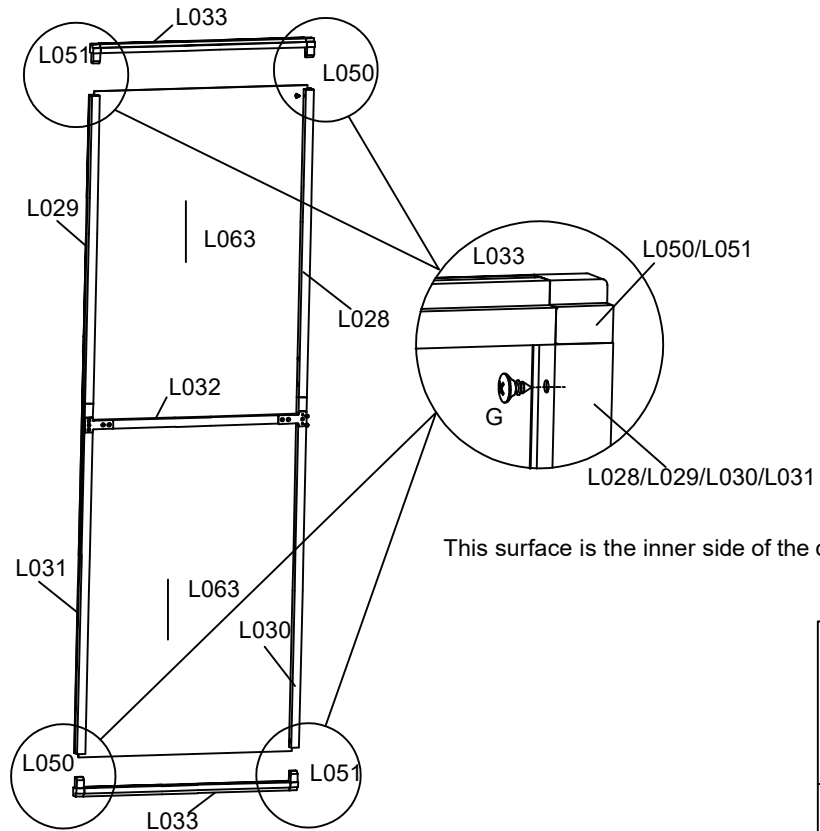

L063*2
G*4
M4*12

## STEP 35

Assembly Completed

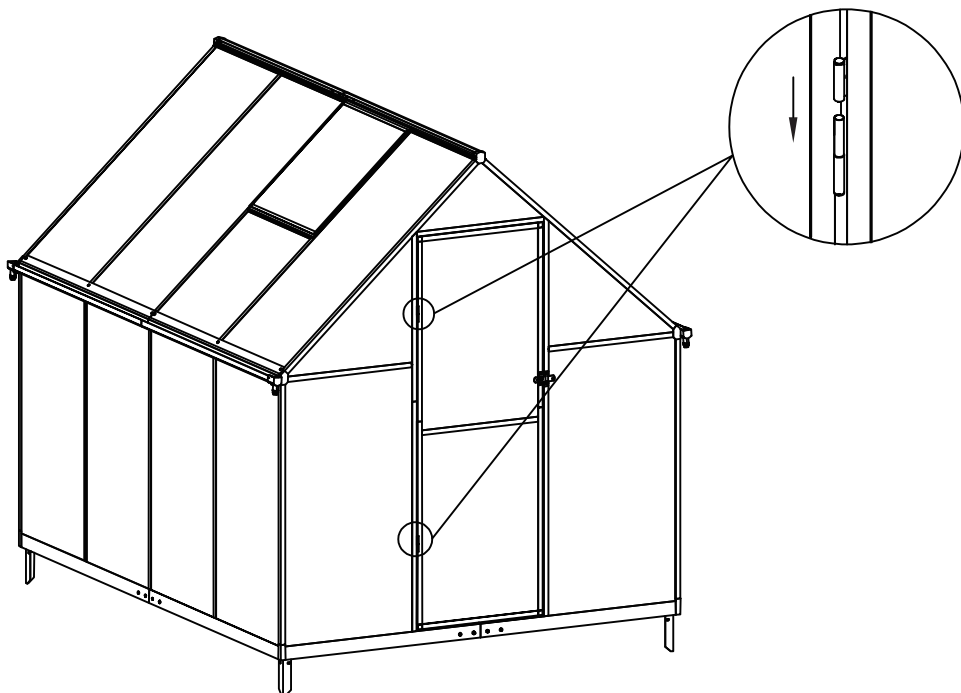

# Installation steps

## STEP 36

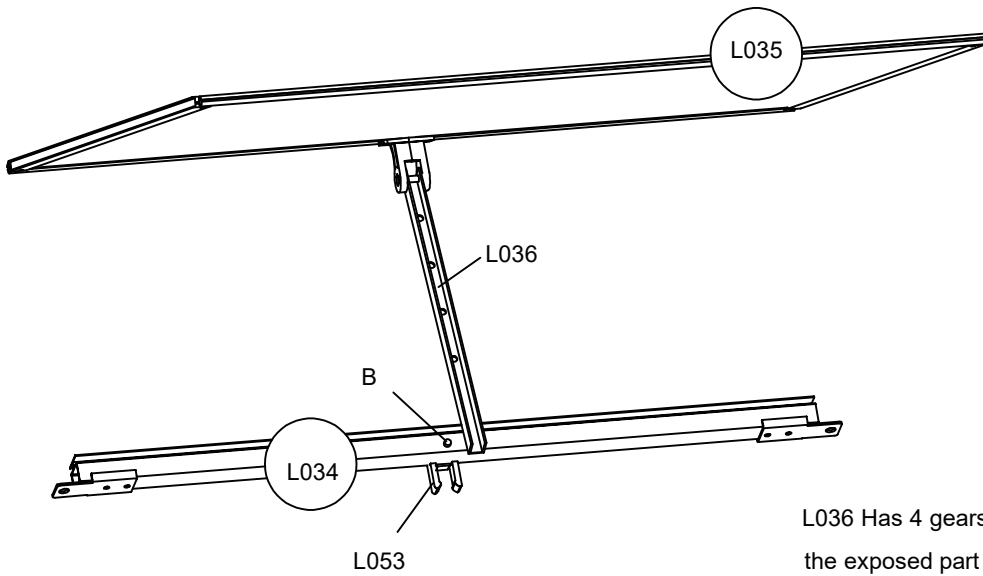
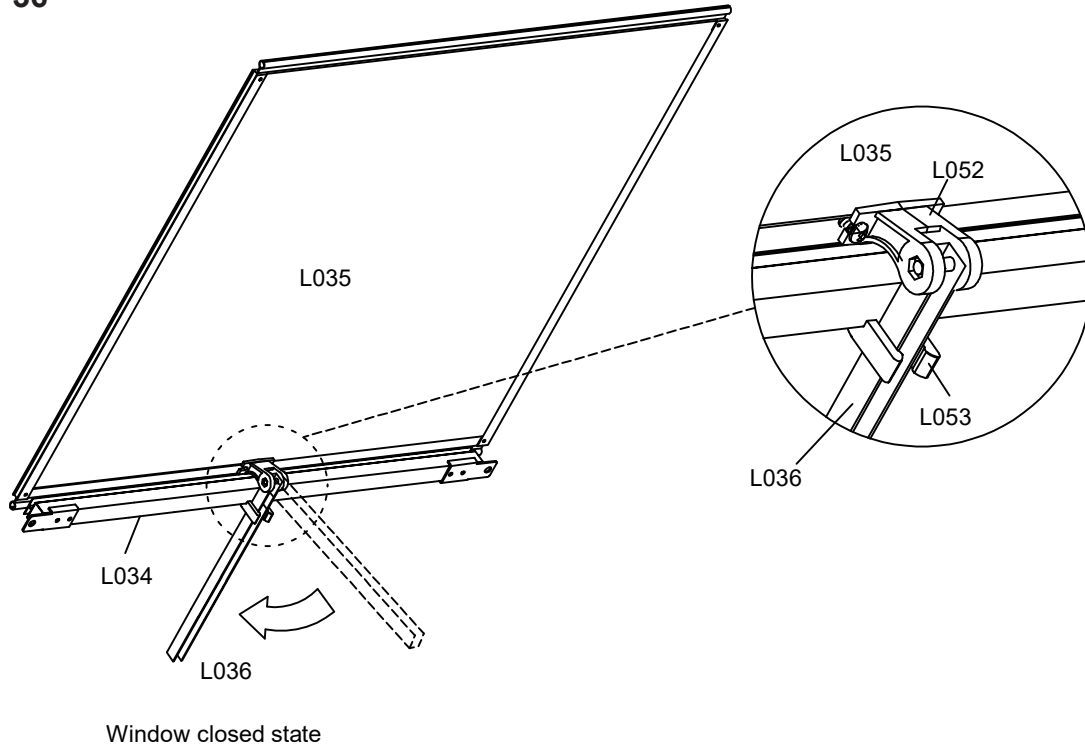

L036 Has 4 gears, and the exposed part of B can be engaged as needed.

Window open status



