

# Installation Instructions

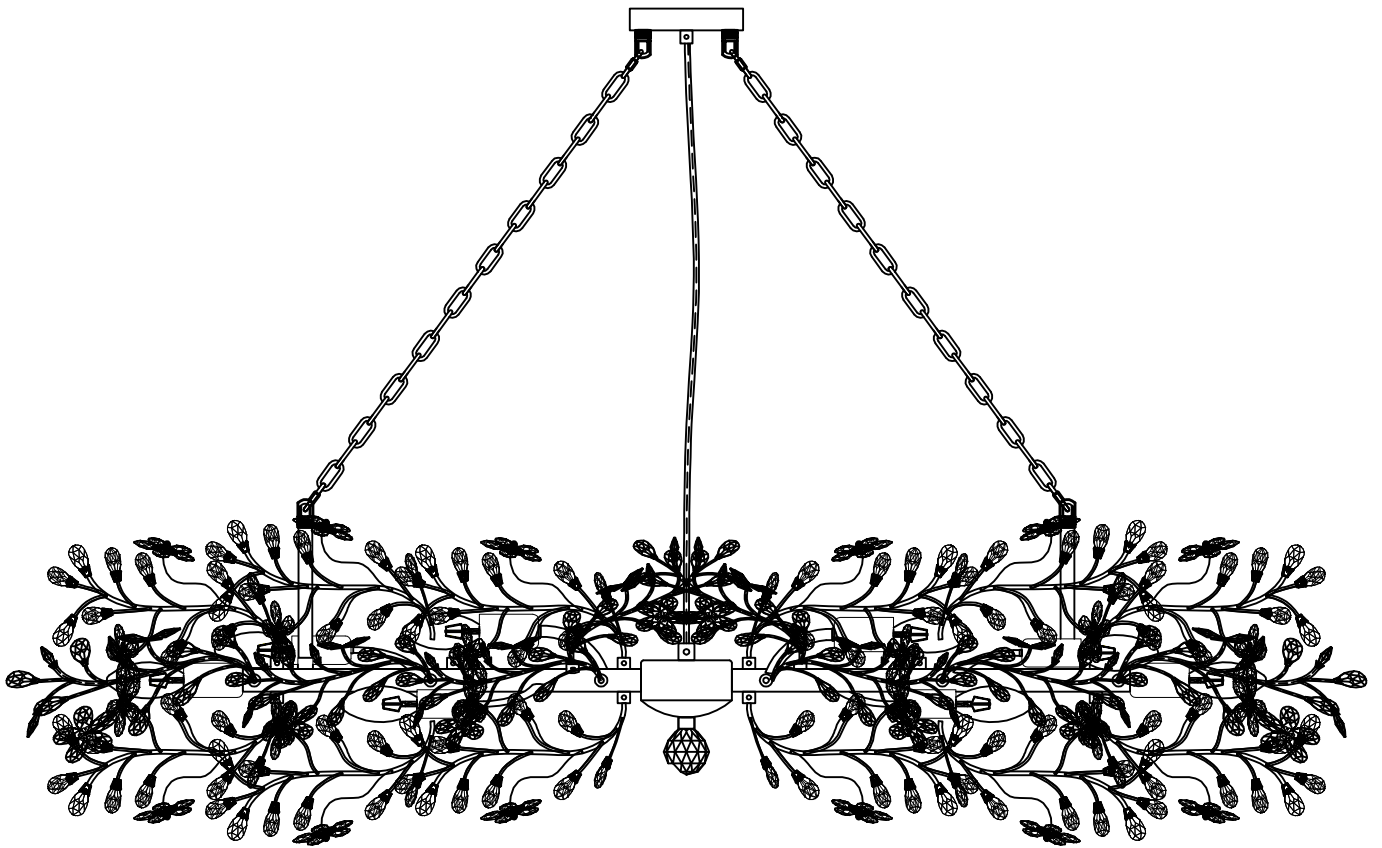

# Chandelier Installation and Safety Standards

The installation of a chandelier is a crucial step in ensuring its safety. Chandelier safety standards dictate the process of installation, including the tools and equipment that can be used, the methods of securing the chandelier, and the location of the chandelier.

Securing the chandelier is a crucial step in the installation process. Chandelier safety standards dictate that the chandelier must be securely attached to a suitable support, such as a ceiling joist, to prevent it from falling. This includes ensuring that the support is strong enough to bear the weight of the chandelier, and that the chandelier is properly balanced to prevent it from tipping or swaying.

Furthermore, the chandelier must be secured using suitable hardware, such as screws or bolts, that are strong enough to bear its weight. The hardware must be properly installed and tightened to ensure that the chandelier is securely attached. Regular inspections of the hardware are also necessary to detect and repair any damage or wear promptly.

# Package

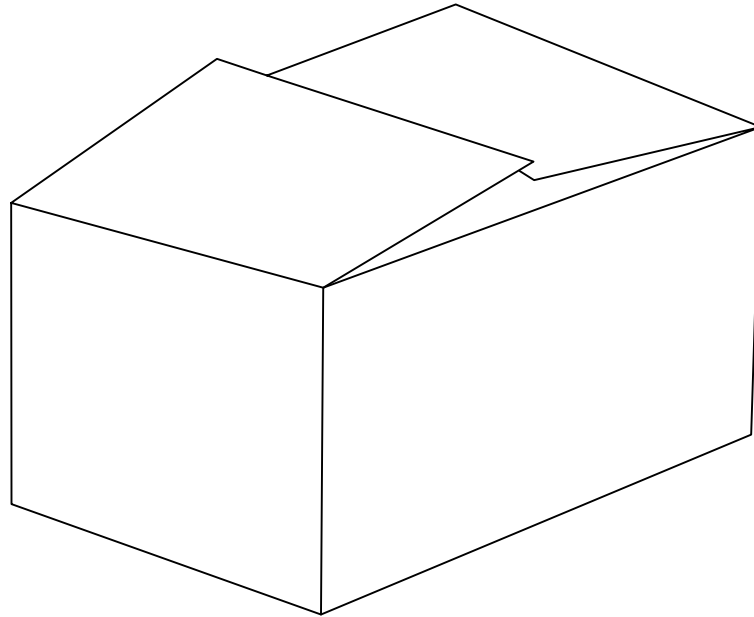

①

A+B+C+D+G+H+I		
E+F	E+F	E+F
E+F	E+F	E+F

## Internal Packing List:

1. The first layer of the lamp body
2. Second layer of lamp body + crystal+lamp body accessories

## Before assembly:

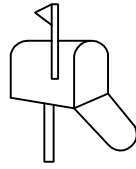

- ★ Please read all the instructions carefully
- ★ Keep the instruction manual for future reference.
- ★ Separate and inventory all parts and hardware
- ★ Read each step carefully and follow the correct installation sequence
- ★ To avoid losing any parts during assembly, we recommend not moving the lamp before completing the assembly. Always place the product on a flat, firm, and stable surface
- ★ Keep all small parts and packaging materials of this product away from babies and children, as they may cause serious injury

# Accessory list

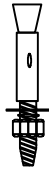

4pcs



2+2pcs



10pcs

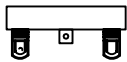

A. Ceiling chime bell-1pcs

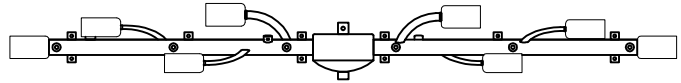

B. Main lamp stand-1pcs



C. Chain link-2+2+2pcs

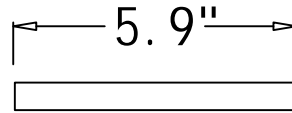

D. Boom-2pcs

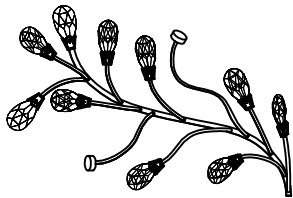

E. Main lamp stand-26pcs

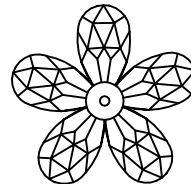

F. Crystal flower-52+4pcs



G. Decorative piece-104+8pcs



H. Flat head nut-52+4pcs

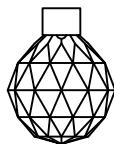

I. Crystal ball-1pcs

# ① Fixture Assembly:

- (1), Locate the lamp body from the sorting list.
- (2), Install the D boom according to the diagram onto the B lamp body.
- (3), Connect the C chain to the D boom and attach it to the A ceiling mount.  
Then insert the power cord into the A ceiling mount.
- (4), Install the I crystal ball onto the C main lamp stand.
- (5), Install the numbered G, F, and H in sequence according to the diagram onto the main lamp frame of E.

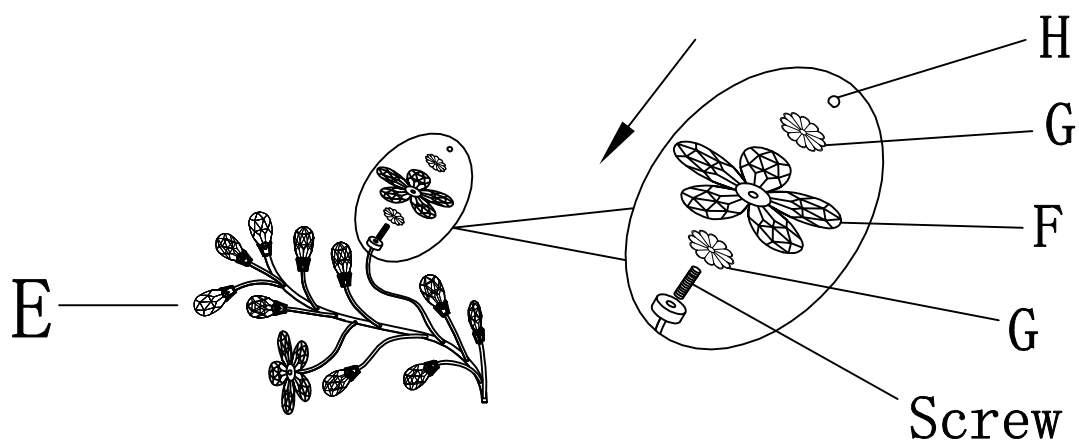
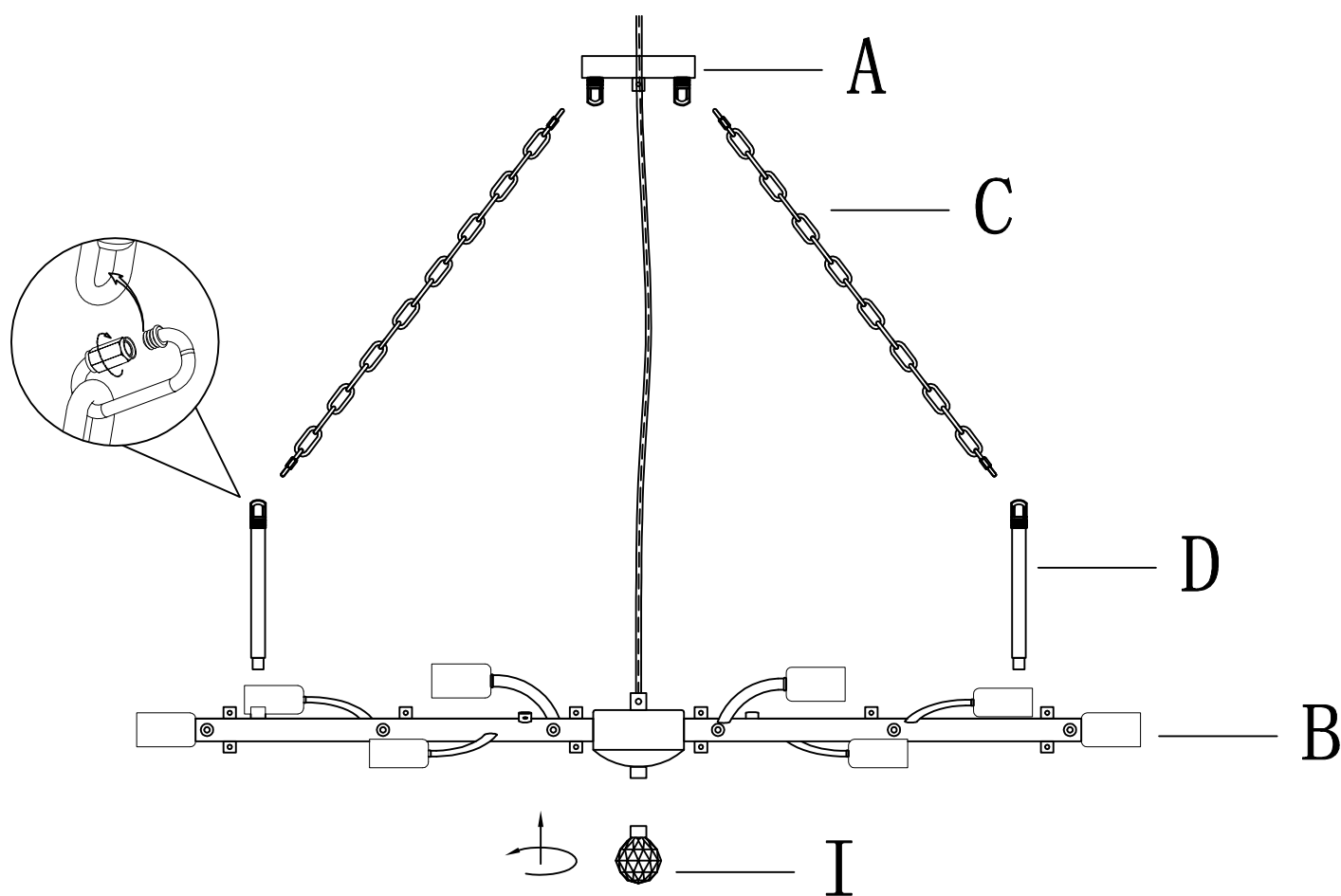

## ② Light Source and Lampshade Assembly:

- (1), Remove the hanging plate and connect it to the wall.
- (2), Connect the main power line to the main light body line and lock the ceiling plate.
- (3), Screw in 8 E12 bulbs into the light head (not included in the product).
- (4), Install the assembled E main light frame on the B main light frame and tighten it with screws.
- (5), Installation completed.



**WARNING:** E12 The light bulb,  
MAX25W TYPE B BULB\* 8PCS.

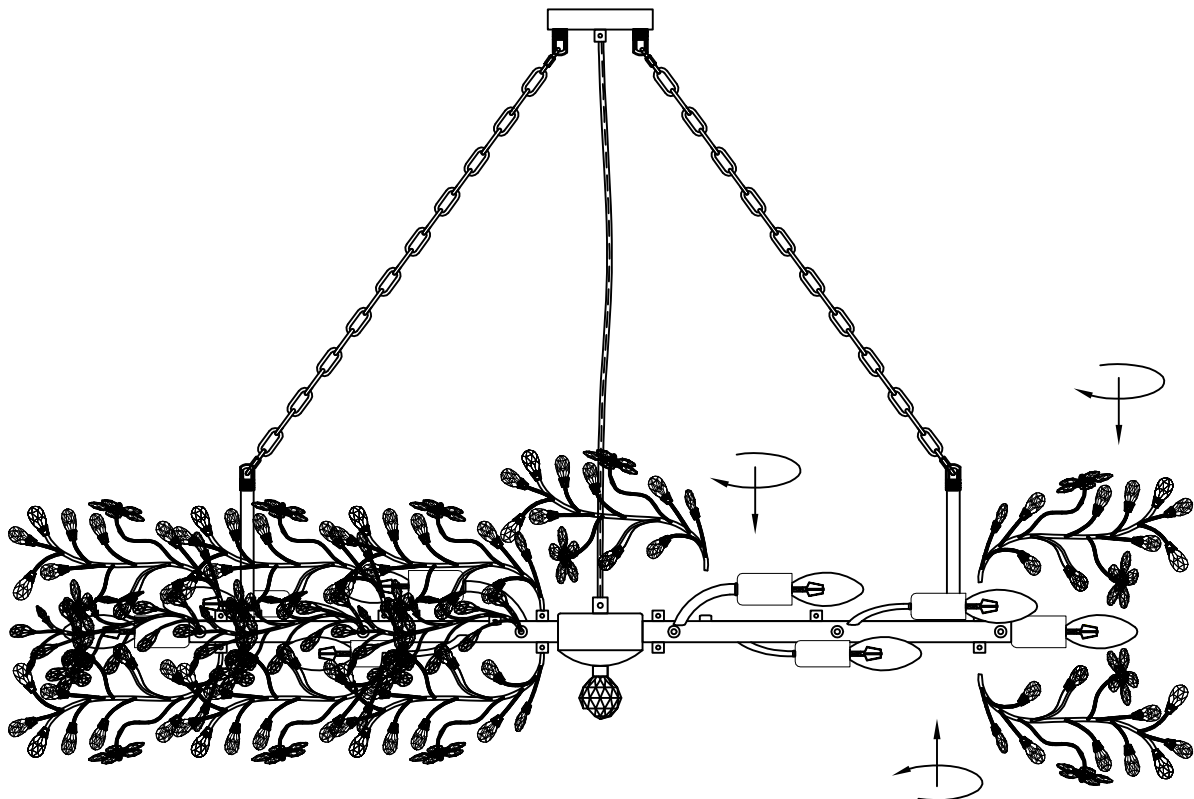
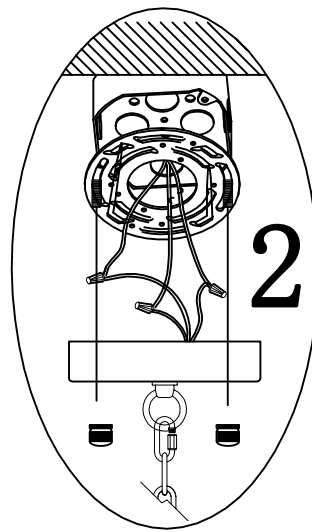
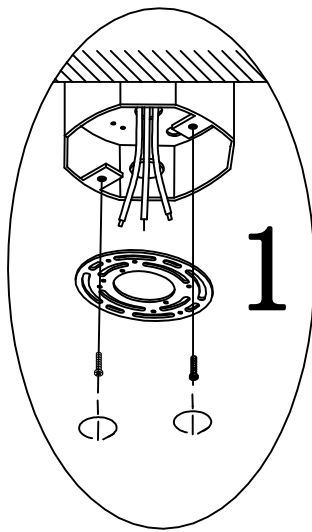

★ If your product has any issues upon receipt, please:

1. Provide your order number.

2. Attach a photo or video of the issue.

3. Contact us through the platform's customer service.