









ASSEMBLY INSTRUCTIONS

Item	Parts	Picture	Qty
1	Stool Body		1
2	Back Leg		1
3	Front Leg		1
4	Side Rail		2

Item	Hardware	Picture	Qty
A	Bolt	 $\varnothing 5/16" \times 2"$	9
B	Spring Washer		9
C	Flat Washer		9
D	Allen Wrench		1
E	Screw	 M5x40mm	4

Step 1 : Take off the hardware bag, Front Leg (3) and Side Rail (4) from the small box.

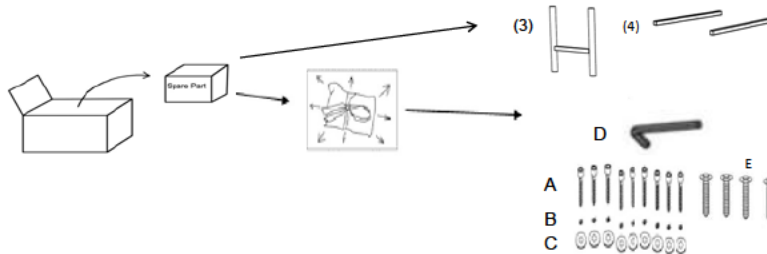

Step 2 : Use bolts (A), lock washers (B), flat washers (C) to connect Stool Body (1) to Back Leg (2) and Front Leg (3). Please do not tighten bolts (A) with Allen Key (D) very well.

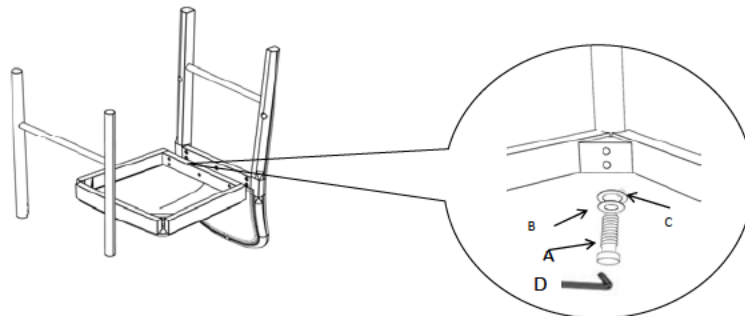

Step 3 : Insert the Side Rail (4) to the Front Leg and Back Leg, tighten the all the bolts (A) in the step 2 well. Then use the driver to tighten the screws (E) as below :

