

ASSEMBLY INSTRUCTIONS
FULL ROUND BED
INSTRUCTIONS DE MONTAGE
LIT ROND COMPLET

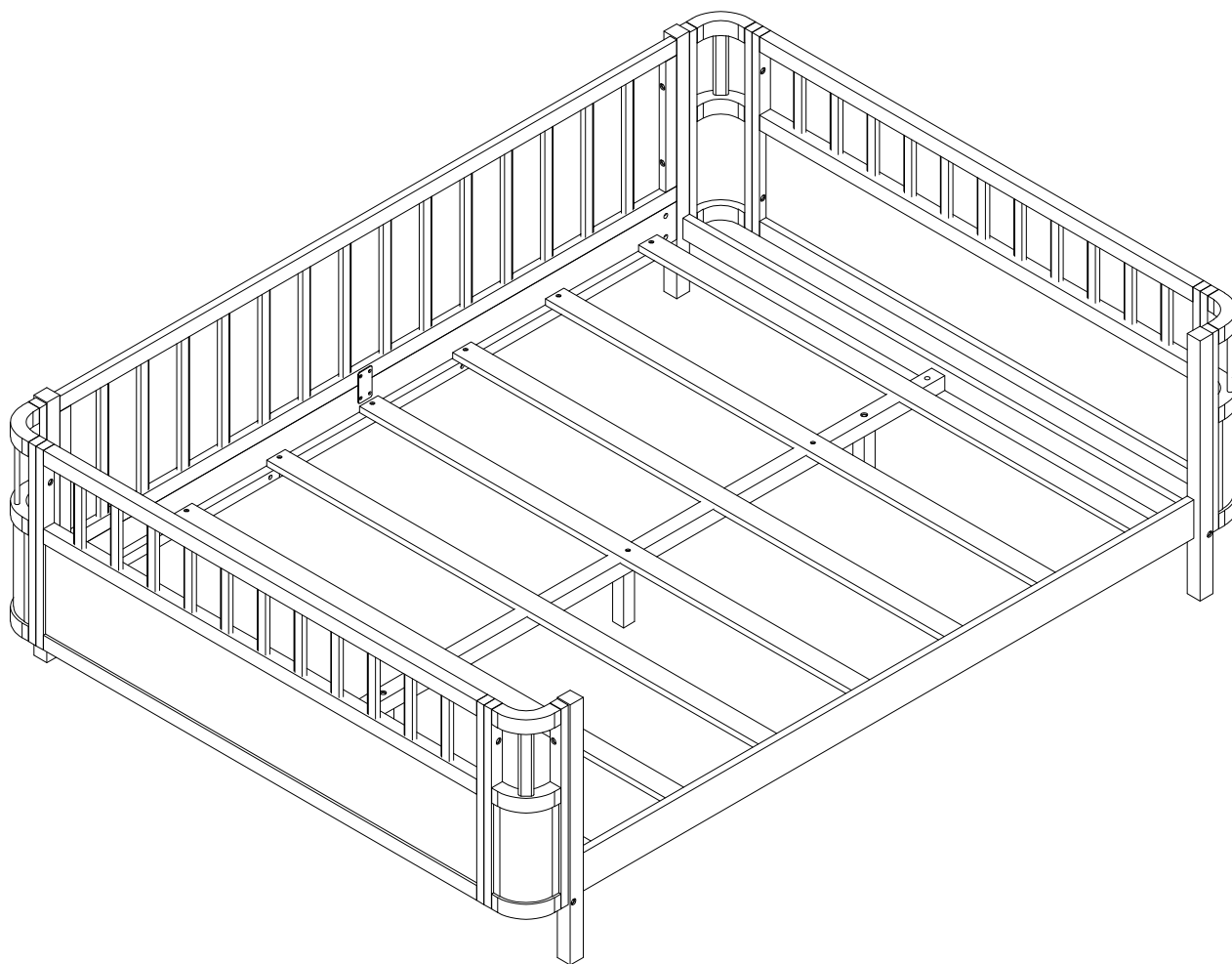

This set is included 1 boxes if don't receive full 1 boxes please contact our customer service team.





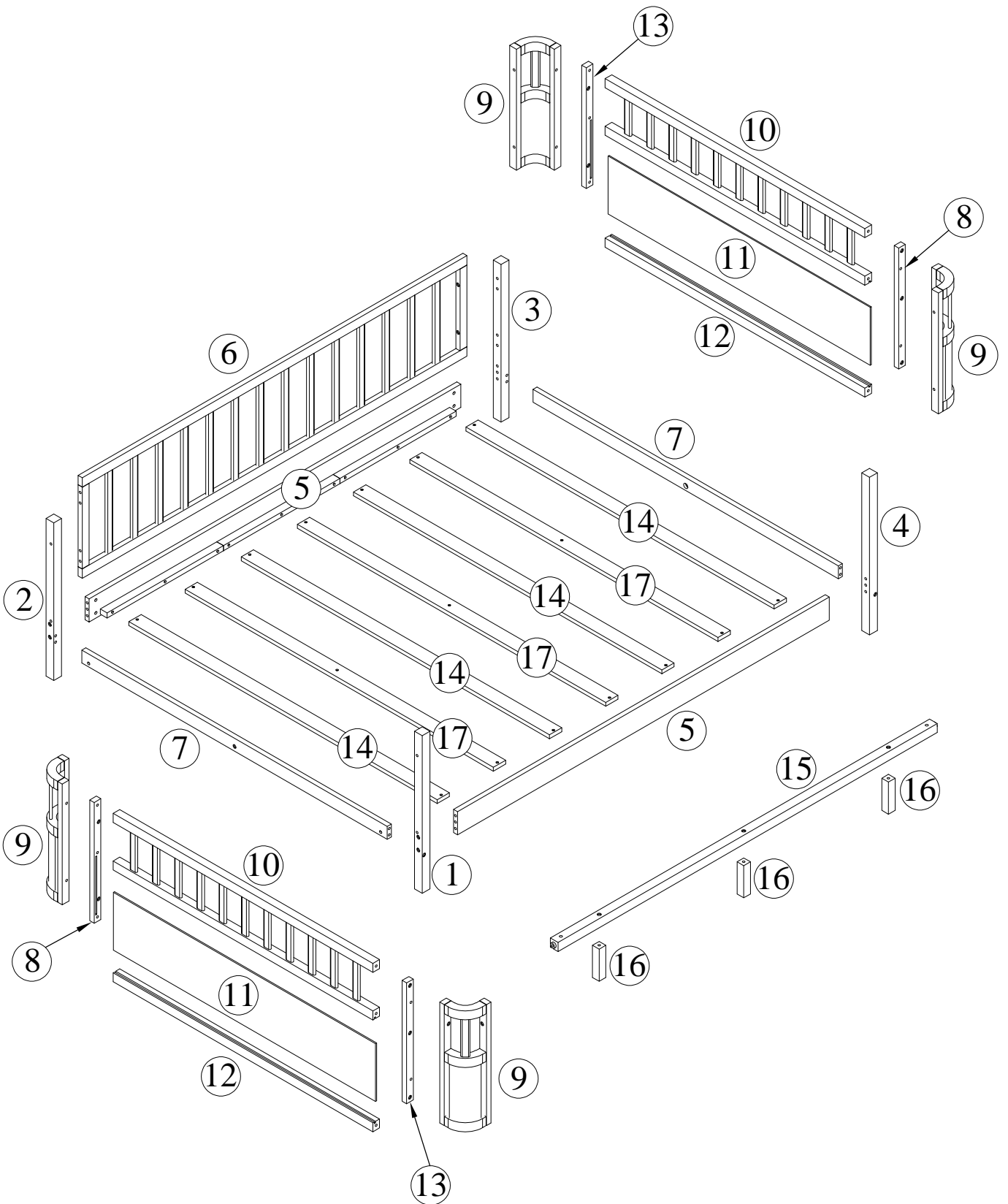

Cet ensemble comprend 1 boîtes. Si vous ne recevez pas 1 boîtes complètes, veuillez contacter notre service client.

Detail View
vue détaillée

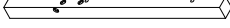
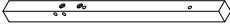
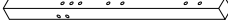
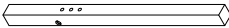
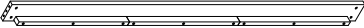
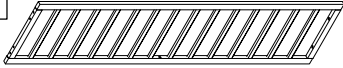
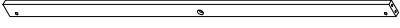

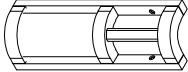
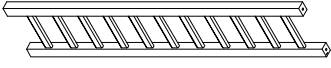
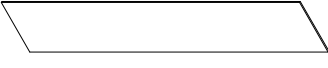



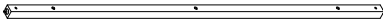
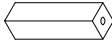
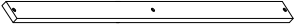

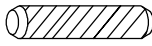
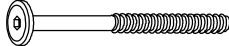

Part List

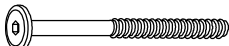
Liste des pièces

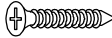
<p>1</p>  <p>Left Front Leg-1pc Jambe avant gauche</p>	<p>2</p>  <p>Left Hind Leg-1pc Patte arrière gauche</p>	<p>3</p>  <p>Right Hind Leg-1pc Patte arrière droite</p>
<p>4</p>  <p>Right Front Leg-1pc Jambe avant droite</p>	<p>5</p>  <p>Bed Shoulder-2pcs Épaule du lit</p>	<p>6</p>  <p>Rear Railing Frame-1pc Cadre de garde-corps arrière</p>
<p>7</p>  <p>Bottom Brace-2pcs Renfort inférieur</p>	<p>8</p>  <p>Standing Hip Puzzle-2pcs Puzzle de la hanche debout</p>	<p>9</p>  <p>Curved Frame-4pcs Cadre courbé</p>
<p>10</p>  <p>Upper Hip Frame-2pcs Cadre de hanche supérieur</p>	<p>11</p>  <p>Side Board-2pcs Buffet</p>	<p>12</p>  <p>Lower Hip Bar-2pcs Barre de hanche inférieure</p>
<p>13</p>  <p>Standing Hip Puzzle-2pcs Puzzle de la hanche debout</p>	<p>14</p>  <p>Slat -4pcs Lamelle</p>	<p>15</p>  <p>Flap Support-1pc Support de rabat</p>
<p>16</p>  <p>Lower Legs-3pcs Jambes inférieures</p>	<p>17</p>  <p>Slat -3pcs Lamelle</p>	

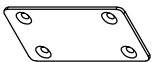
Hardware List Liste du matériel

A	 8 X 30mm. Wooden dowel (12pcs) Cheville en bois	B	 Ø1/4" x 70mm Hex-head bolt (12pcs) Boulon à tête hexagonale	C	 Ø1/4" x 13mm Horizontal-hole bolt (14pcs) Boulon à trou horizontal
D	 Ø1/4" x 50mm Hex-head bolt (9pcs) Boulon à tête hexagonale	E	 Ø1/4" x 35mm Hex-head bolt (20pcs) Boulon à tête hexagonale	G	 Ø1/4" x 15mm Sleeve nuts (8pcs) Écrous à manchon
H	 #4 x 30mm Screw (17pcs) Vis	I	 K4mm Allen key (1pc) Clé Allen	J	 Ø1/4" x 30mm Hex-head bolt (8pcs) Boulon à tête hexagonale
F	 2x50x80mm Straight bracket (1pc) Support droit	K	 #3.5 x 15mm Screw (4pcs) Vis		





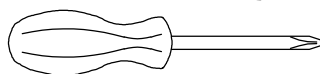

Please sort out all parts before you begin to assembly the item. This is to make sure you always use the correct part.
Veuillez trier toutes les pièces avant de commencer à assembler l'article. Ceci afin de vous assurer que vous utilisez toujours la bonne pièce.

ASSEMBLY TOOLS REQUIRED (NOT INCLUDED)
OUTILS D'ASSEMBLAGE REQUIS (NON INCLUS)



PLEASE BE CAREFUL DO NOT DAMAGE THE HOLE POSITION WHEN YOU USE POWER TOOLS !
S'IL VOUS PLAÎT FAITES ATTENTION À NE PAS ENDOMMAGER LE TROU POSITIONNEMENT LORSQUE VOUS UTILISEZ DES OUTILS ÉLECTRIQUES !

STEP-ÉTAPE- 1



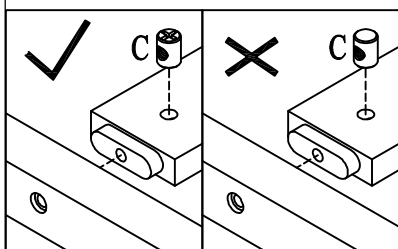
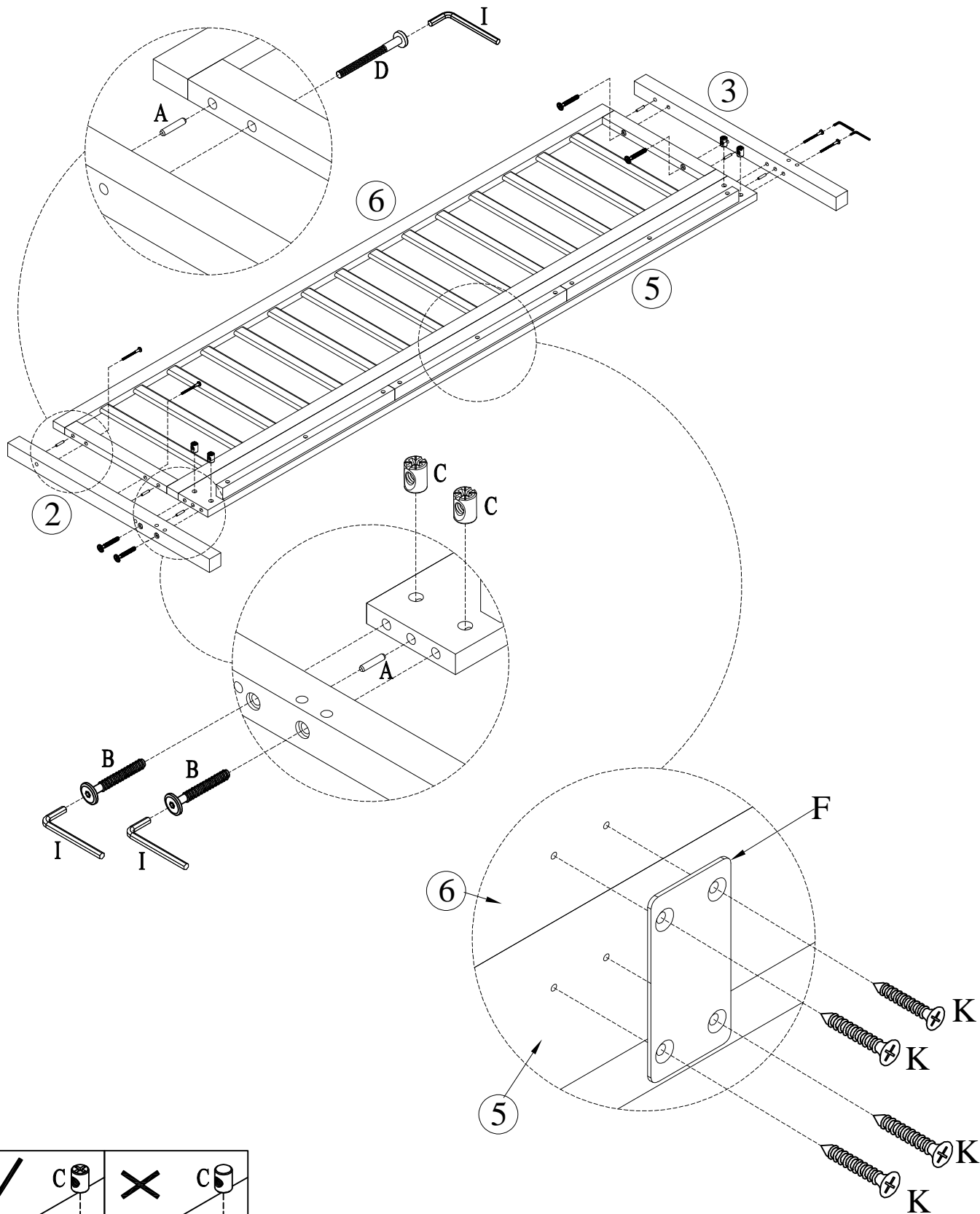

F		K		A		D		I		B		C	
	1PC		4PCS		6PCS		4PCS		1PC		4PCS		4PCS



Note: Part (C) will face up with the "x" mark on it, otherwise it cannot be tightened.



Remarque : la partie (C) sera orientée vers le haut avec la marque « x » dessus, sinon elle ne pourra pas être serrée.

STEP-ÉTAPE- 2

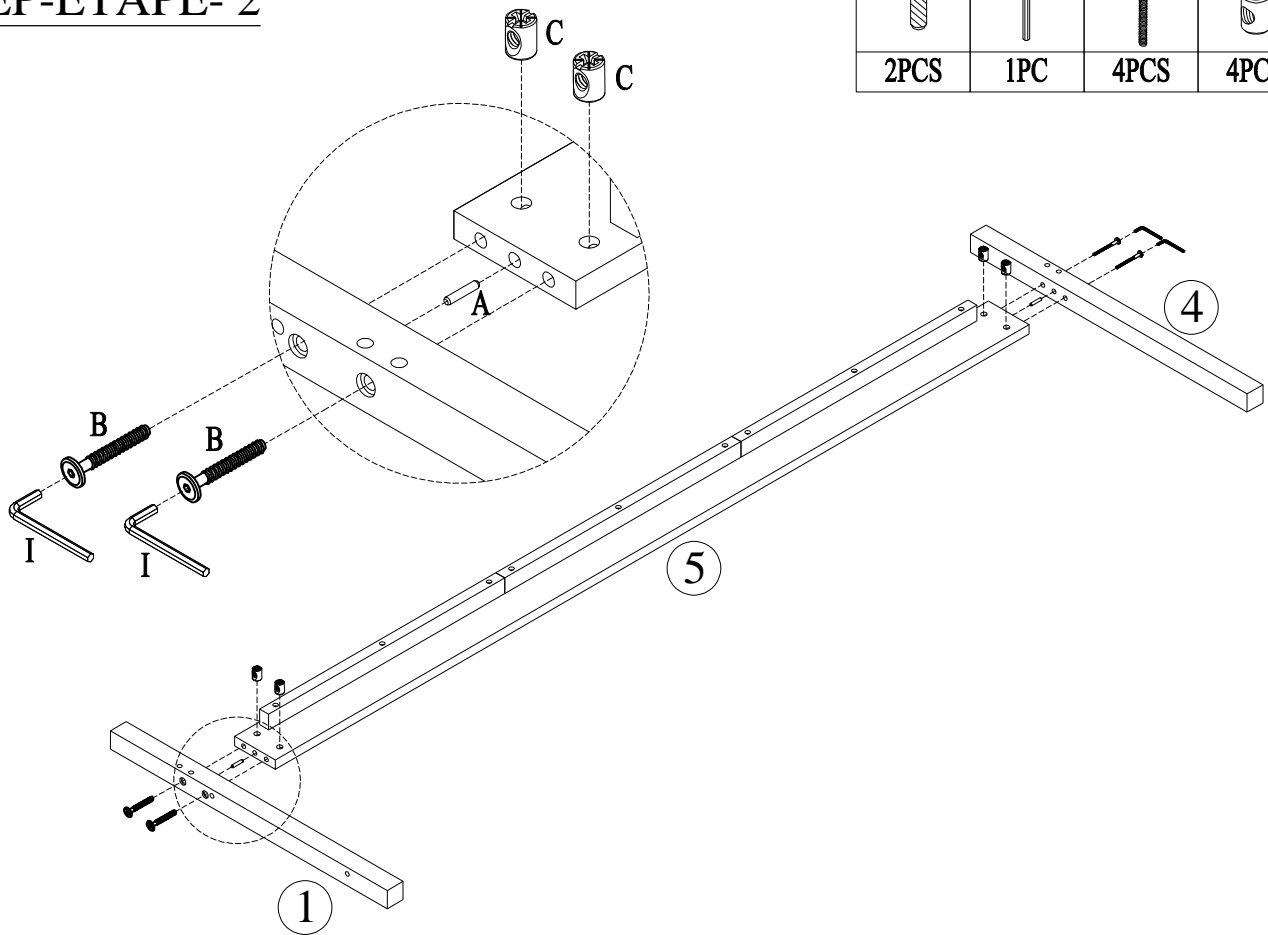
A		I		B		C	
	2PCS		1PC		4PCS		4PCS



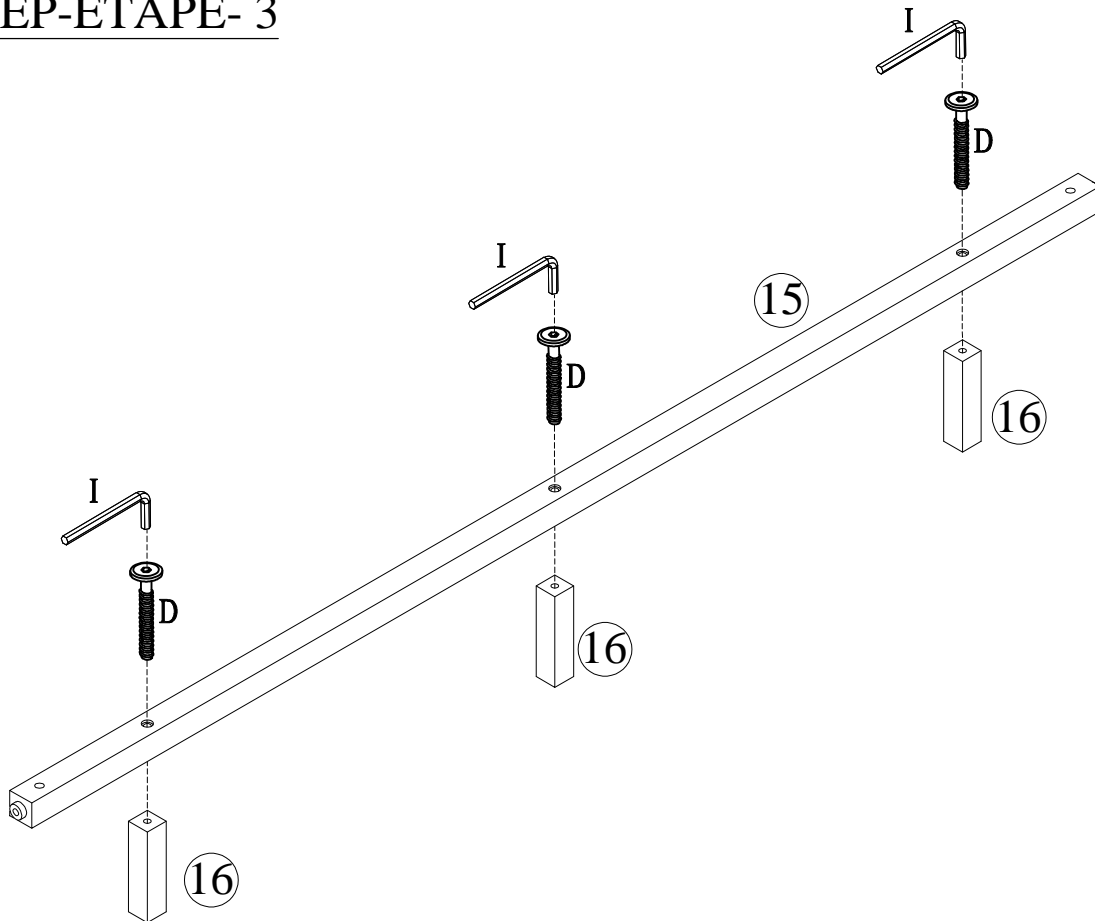

STEP-ÉTAPE- 3

I		D	
	1PC		3PCS



STEP-ÉTAPE- 3



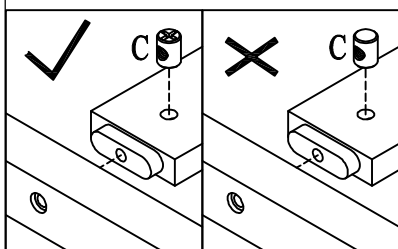
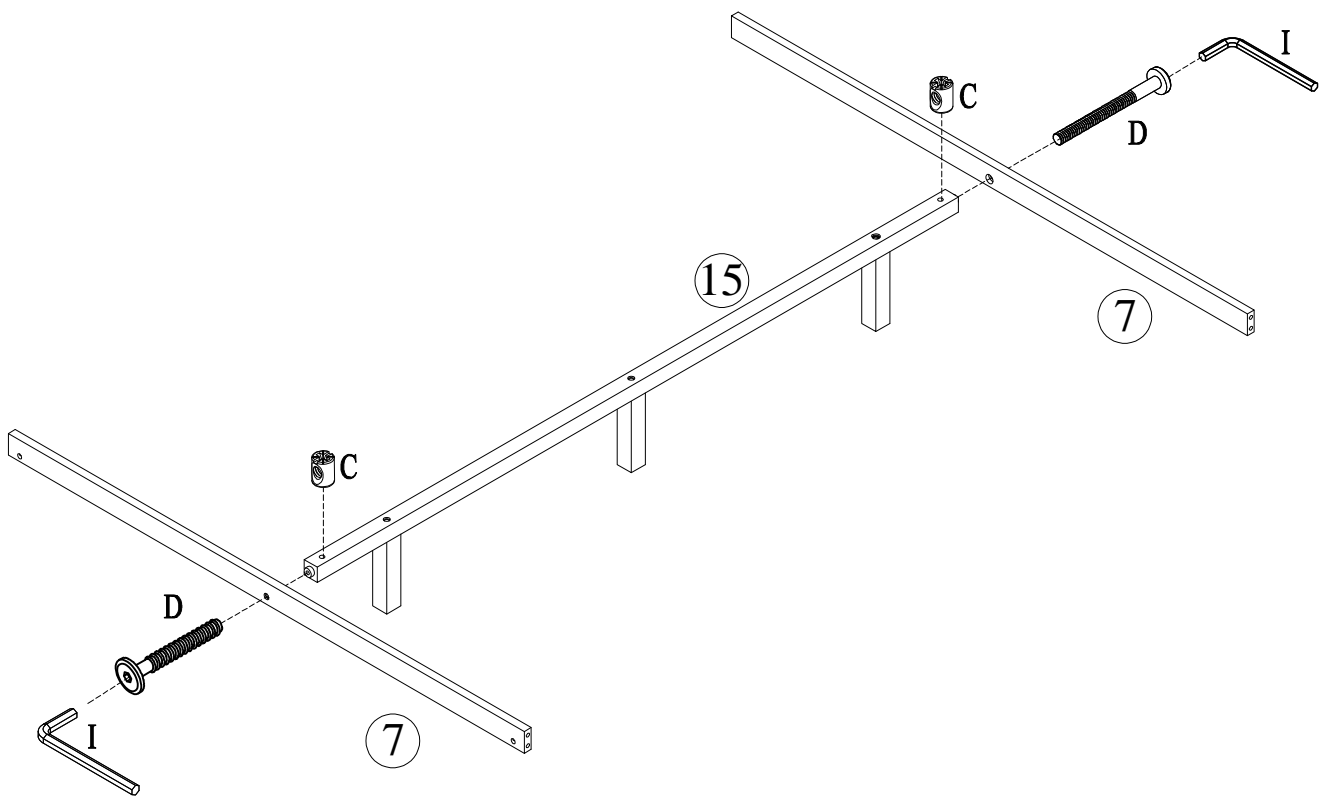

I		D		C	
	1PC		2PCS		2PCS



Note: Part (C) will face up with the "x" mark on it, otherwise it cannot be tightened.

Remarque : la partie (C) sera orientée vers le haut avec la marque « x » dessus, sinon elle ne pourra pas être serrée.

STEP-ÉTAPE- 4

A 	I 	B 	C 
4PCS	1PC	4PCS	4PCS

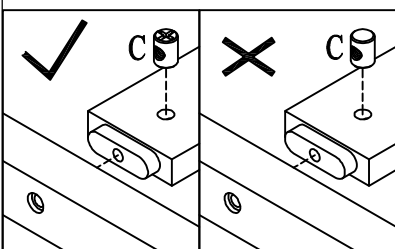
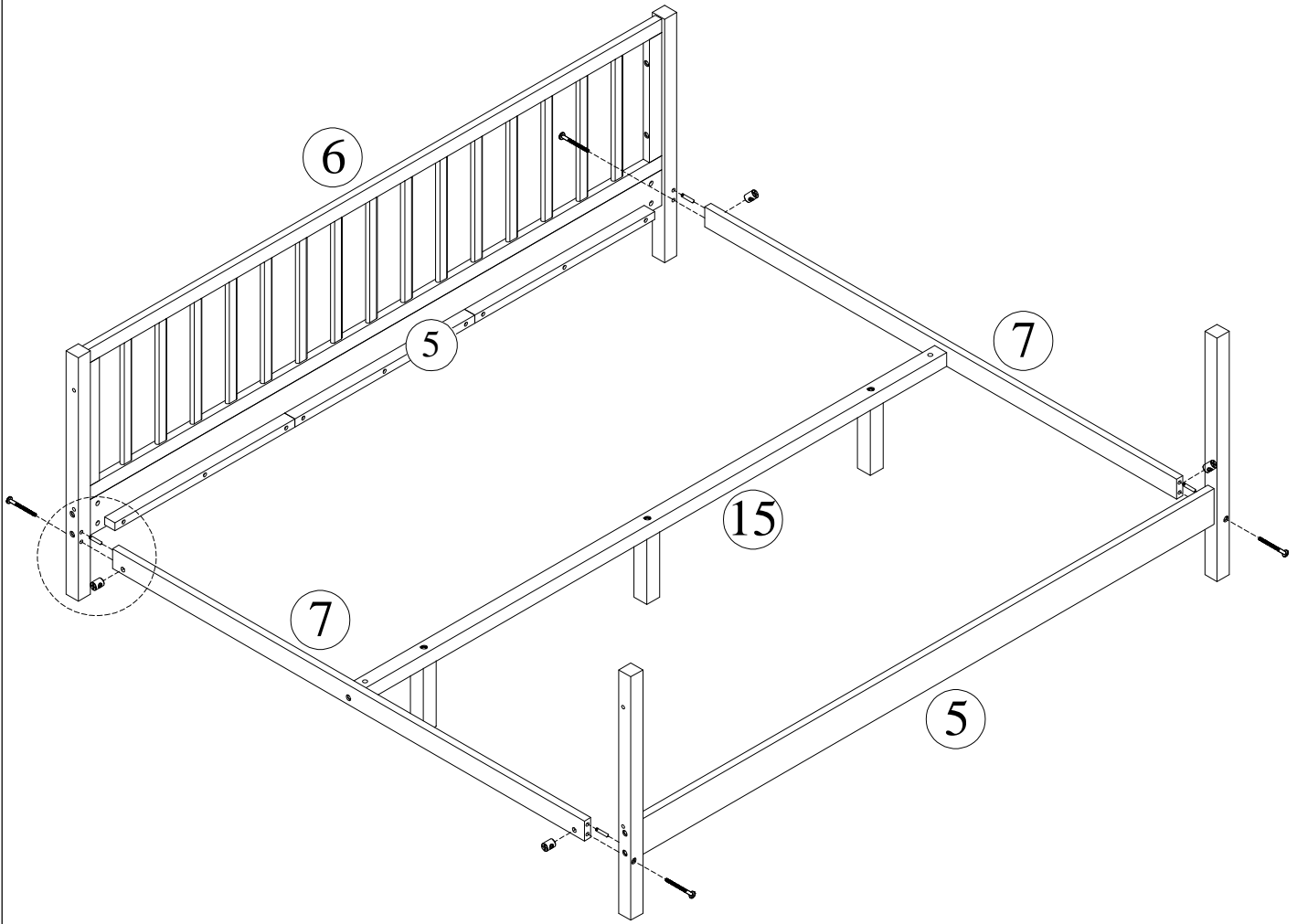
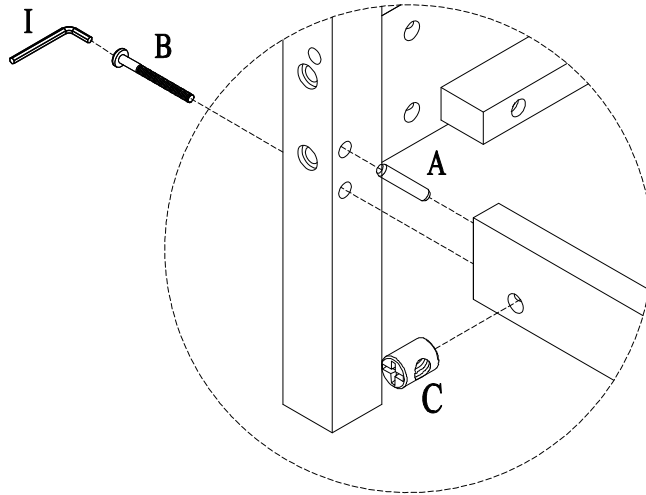

Note: Part (C) will face up with the "x" mark on it, otherwise it cannot be tightened.

Remarque : la partie (C) sera orientée vers le haut avec la marque « x » dessus, sinon elle ne pourra pas être serrée.

STEP-ÉTAPE- 5

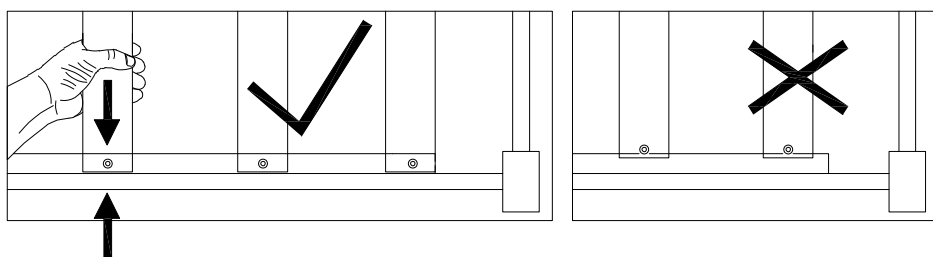
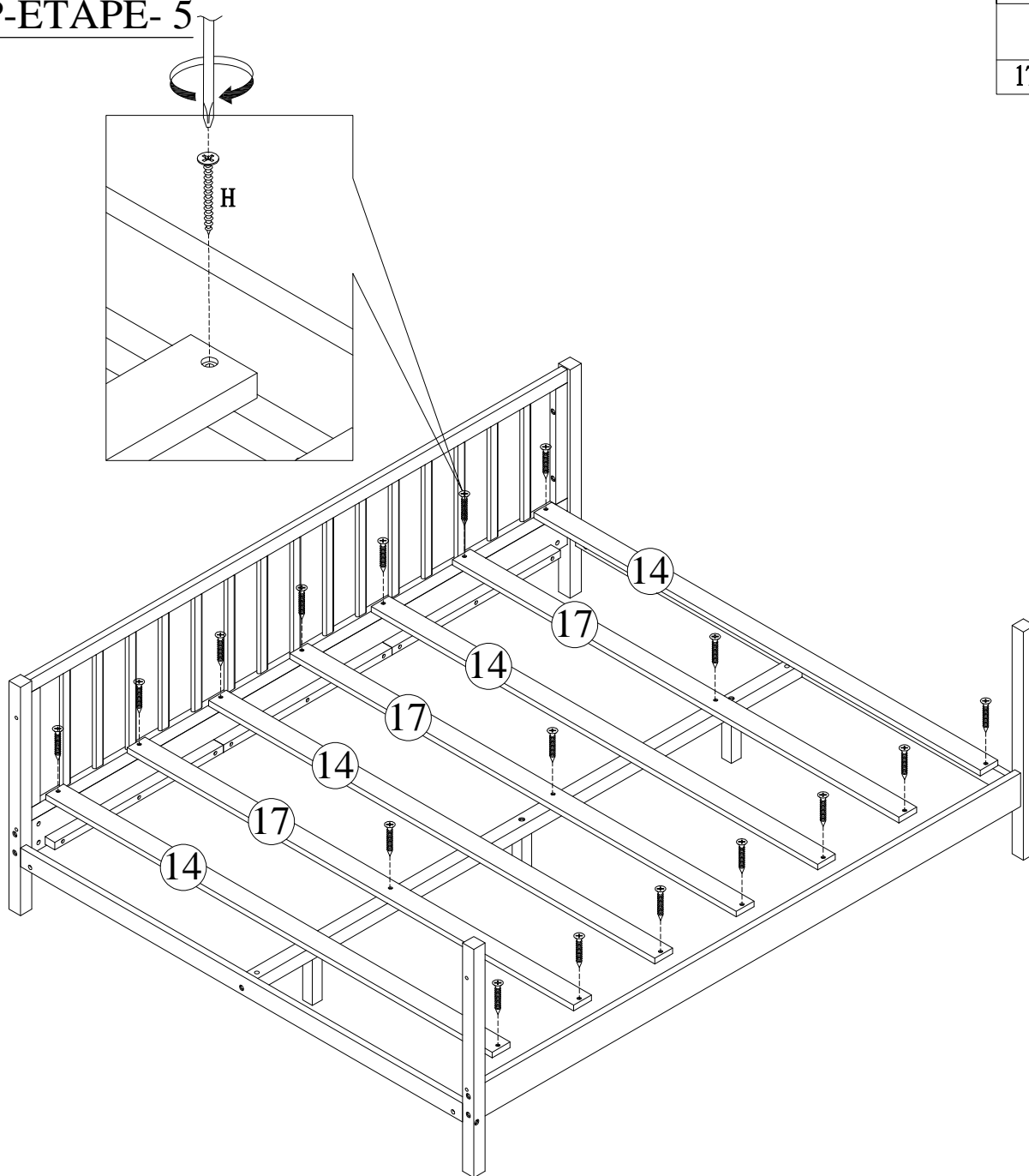

H 
17PCS



NOTE: Please make sure the bed slats close to the side rail before locking the screws to avoid breakage. This step is required for both the left and right sides. Moreover, please do not lock the screws of the bed slats at the outermost edge to avoid damaging.

REMARQUE : Assurez-vous que les lattes du lit sont proches du rail latéral avant de verrouiller les vis pour éviter toute casse. Cette étape est nécessaire pour les côtés gauche et droit. De plus, ne verrouillez pas les vis des lattes du lit sur le bord le plus extérieur pour éviter de les endommager.

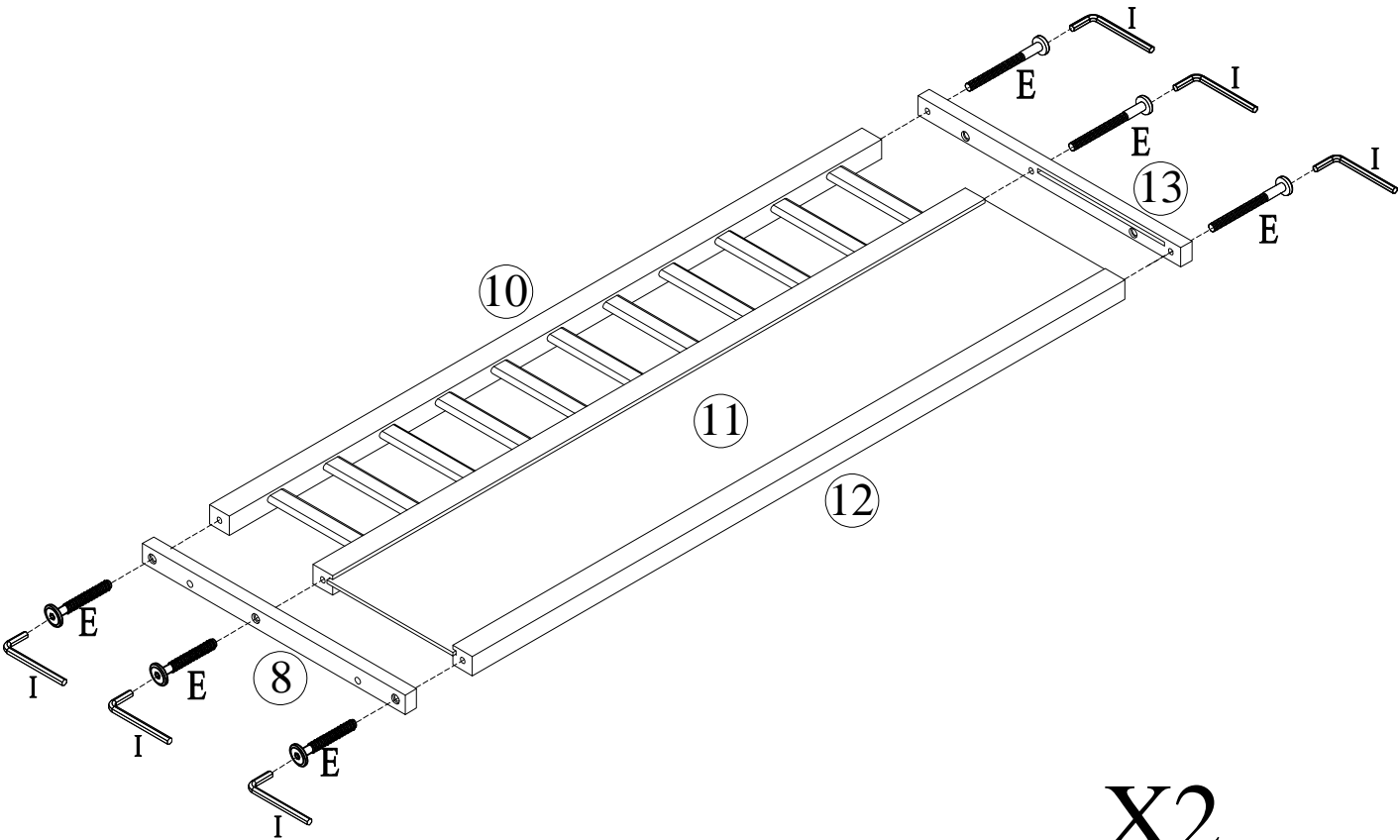
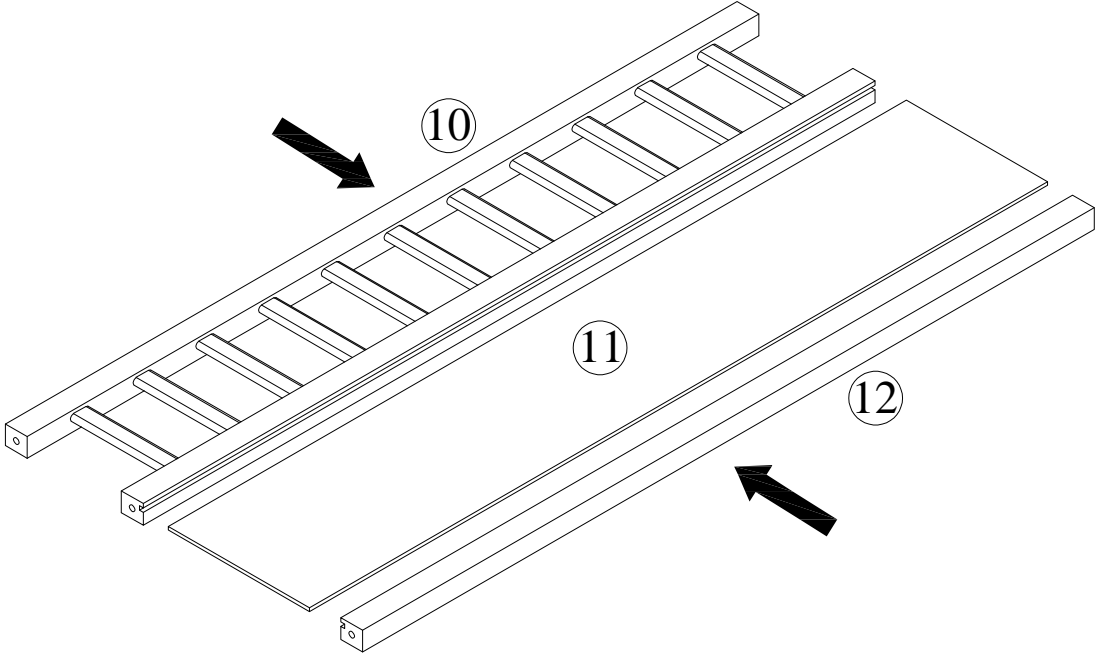

STEP-ÉTAPE-6

I		E	
	1PC		12PCS



X2

STEP-ÉTAPE-7

G 	I 	J 
8PCS	1PC	8PCS

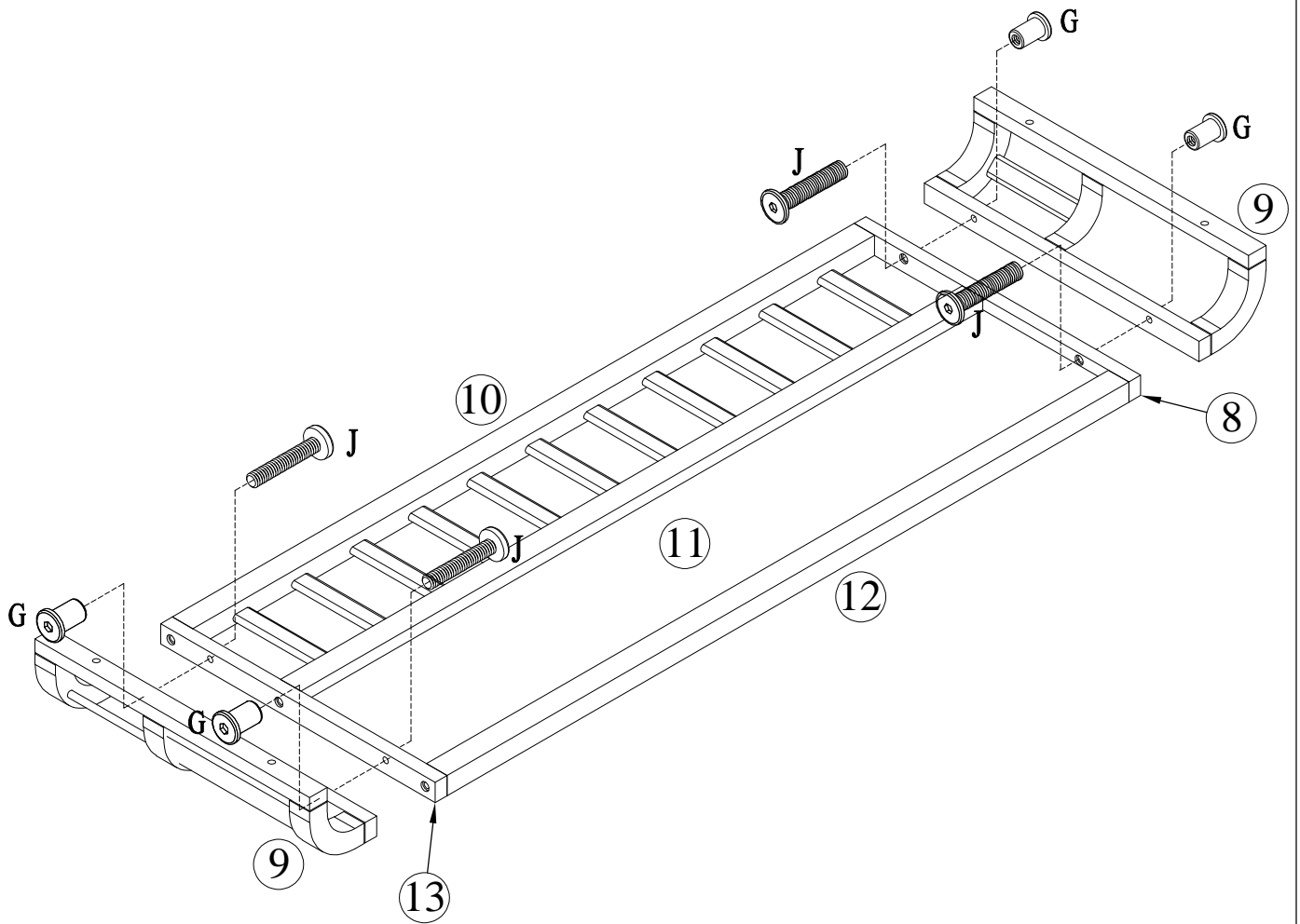

X2

STEP-ÉTAPE-8

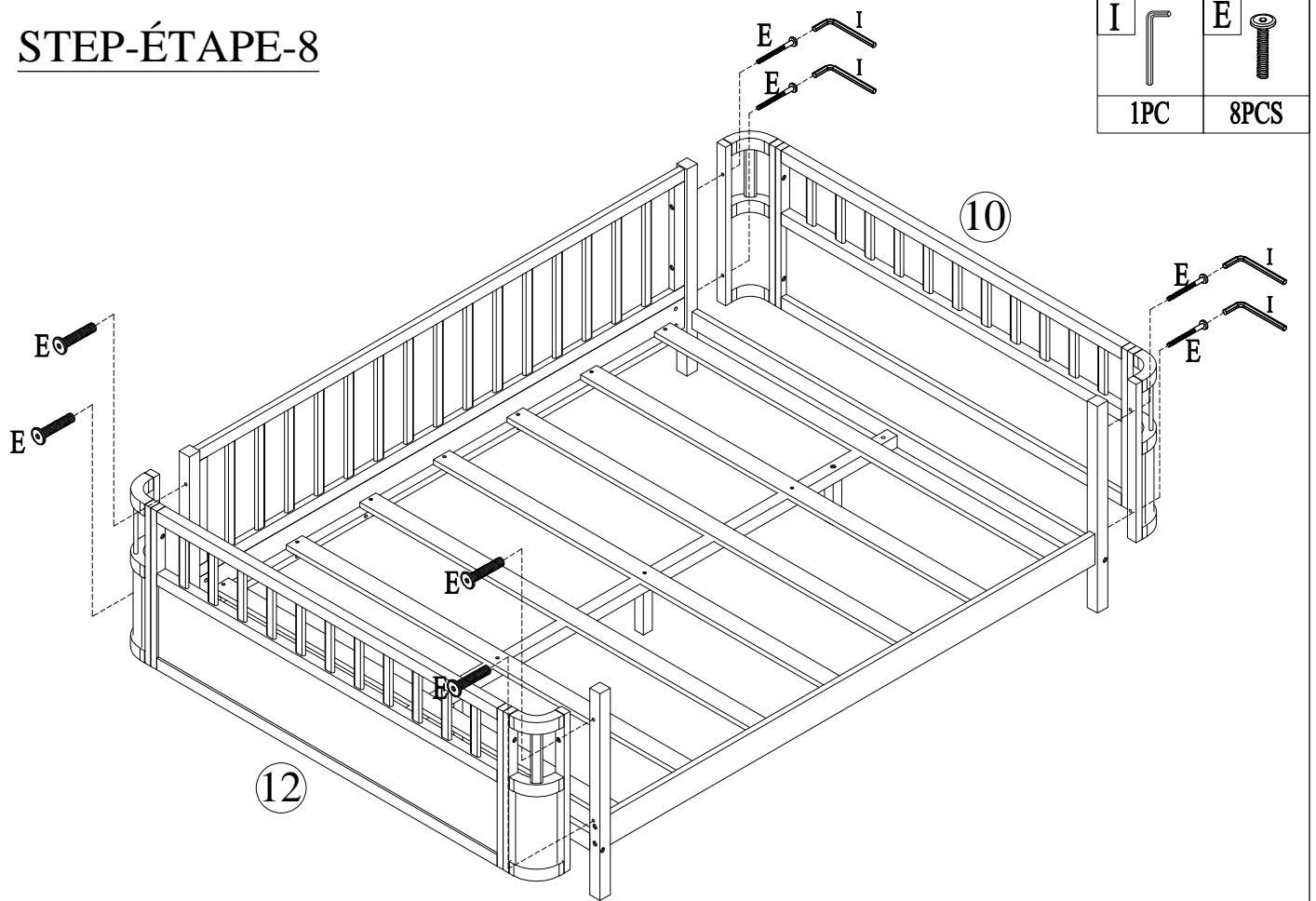

ASSEMBLY COMPLETED
ASSEMBLAGE TERMINÉ

