

ASSEMBLY INSTRUCTION

ITEM : WF324791

DINING CHAIR

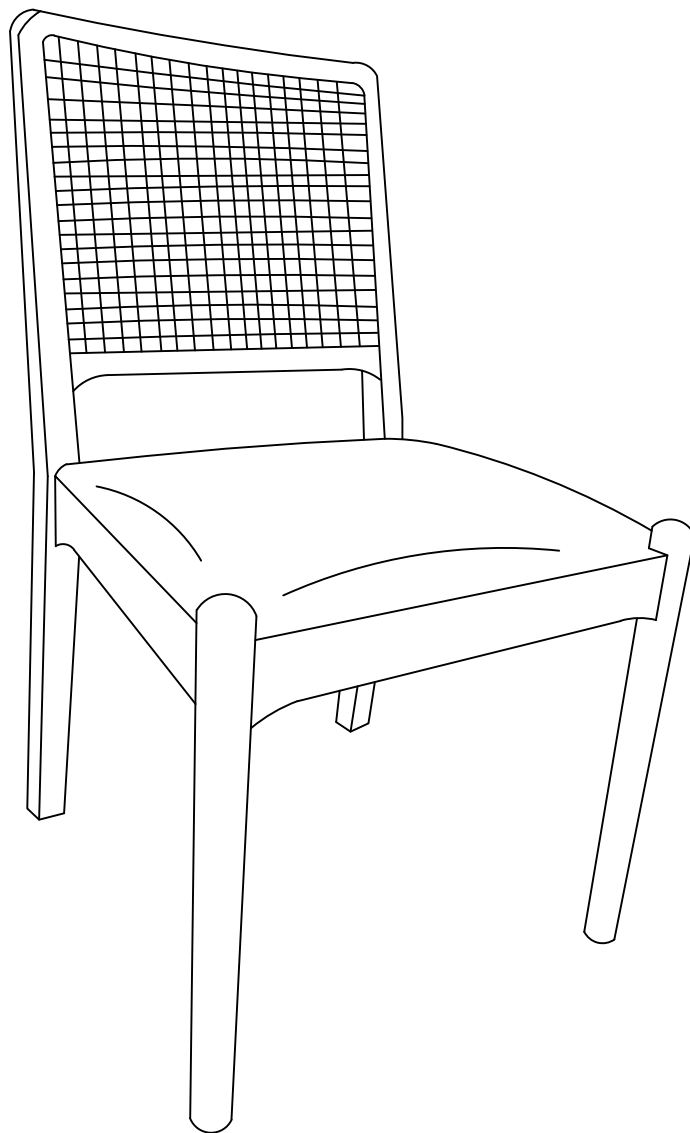

ASSEMBLY INSTRUCTION

ITEM : WF324791

Important Note !

Please read these instructions fully before starting assembly:

1. Place all wooden parts on a clean and smooth surface such as a rug or carpet to avoid scratching the parts
2. Kindly follow the assembly instructions step by step.
3. Do not tighten all screws and bolts until the table is fully assembled.
4. Unscrew the protective plastique supports from the metal insert of the chair legs before assembly.
5. Parts of the assembly will be easier with 2 people.

Care and maintenance:

Only clean using a damp cloth and mild detergent, do no use bleach or abrasive cleaners.





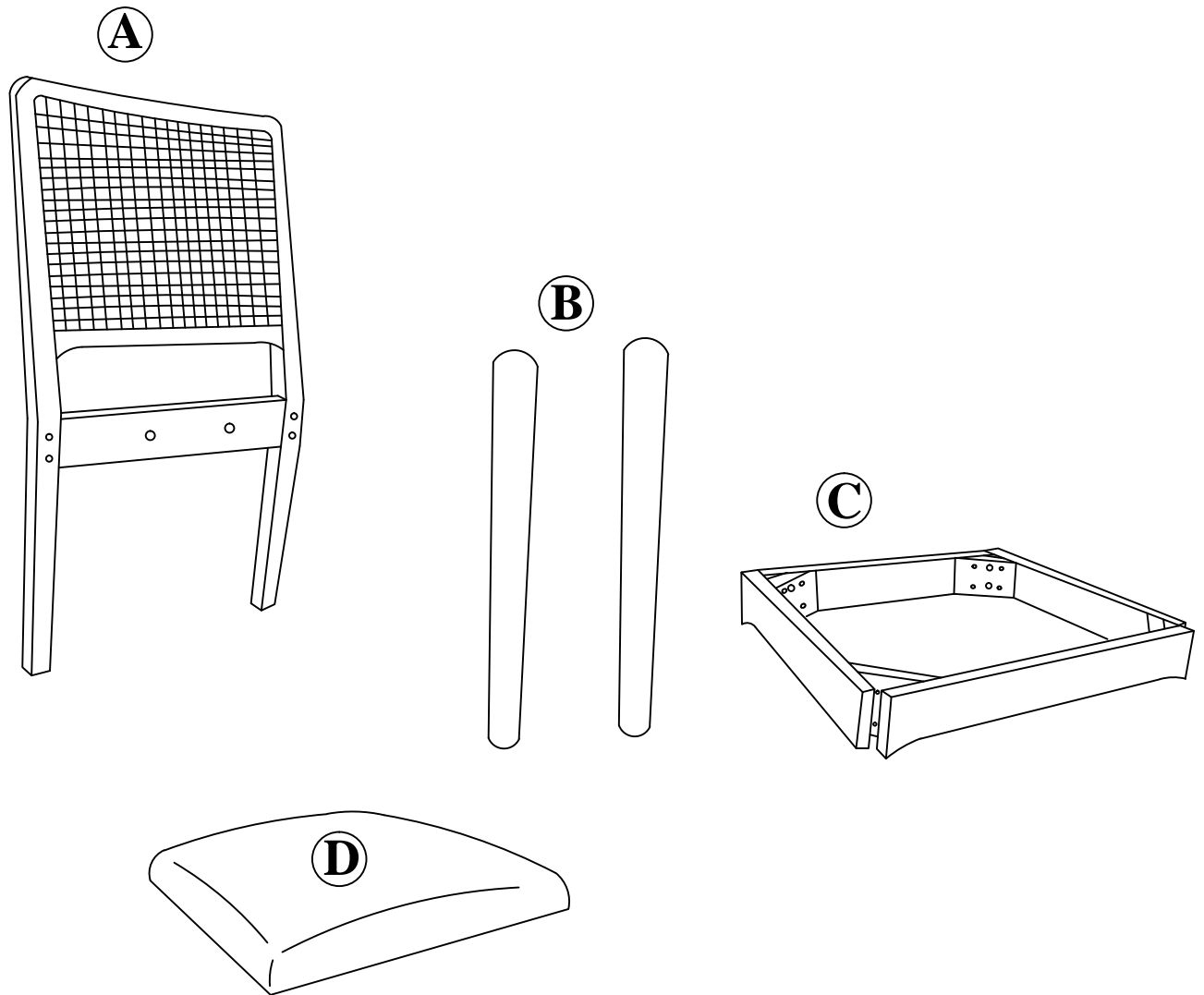

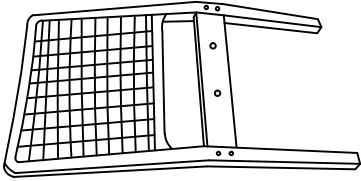

ASSEMBLY INSTRUCTION

ITEM : WF324791

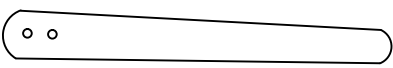

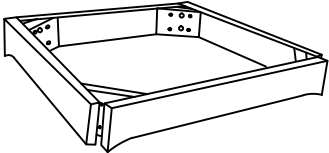
ASSEMBLY INSTRUCTION

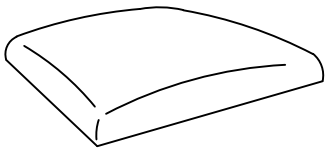
ITEM : WF324791

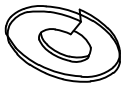
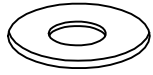
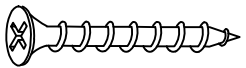
Part List For One	Hardware List For One
<p>A</p> 	<p>1</p> 
<p>BACK REST (1PC)</p>	<p>ALLEN KEY (1PC)</p>
<p>B</p> 	<p>2</p>  <p>M6*35mm</p>
<p>FRONT LEG (2PCS)</p>	<p>BOLT (2PCS)</p>
<p>C</p> 	<p>3</p>  <p>M6*60mm</p>
<p>BOX SEAT (1PC)</p>	<p>BOLT (4PCS)</p>
<p>D</p> 	<p>4</p>  <p>M6*80mm</p>
<p>CUSHION SEAT (1PC)</p>	<p>BOLT (4PCS)</p>
	<p>5</p> 
	<p>SPRING WASHER (10PCS)</p>
	<p>6</p> 
	<p>FLAT WASHER (10PCS)</p>
	<p>7</p>  <p>M4*32mm</p>
	<p>WOOD SCREW (5PCS)</p>



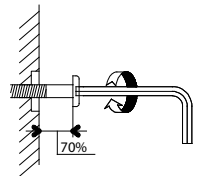
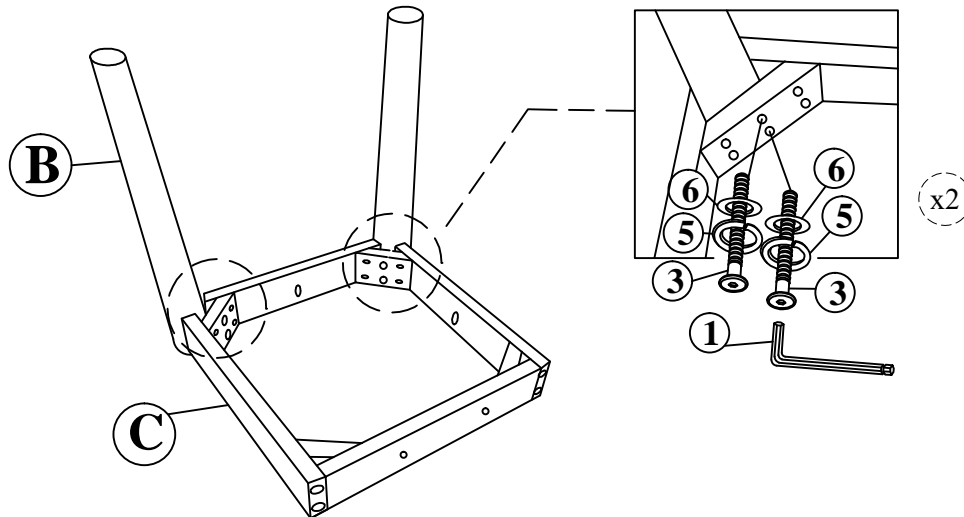

ASSEMBLY INSTRUCTION

ITEM : WF324791

STEP 1





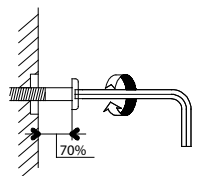
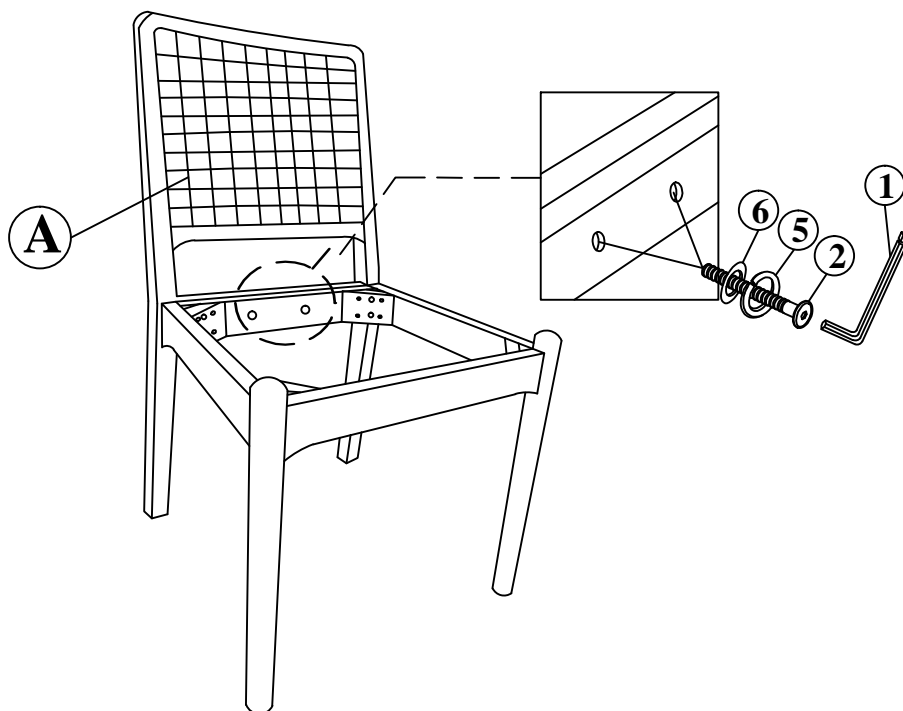

NOTE : Do not fully tighten the bolt

ALLEN KEY (1PC)	BOLT M6*60mm	SPRING WAHER	FLAT WASHER
			
① x 1	③ x 4	⑤ x 4	⑥ x 4

STEP 2



NOTE : Do not fully tighten the bolt

ALLEN KEY (1PC)	BOLT M6*35mm	SPRING WAHER	FLAT WASHER
			
① x 1	② x 2	⑤ x 2	⑥ x 2



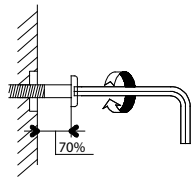
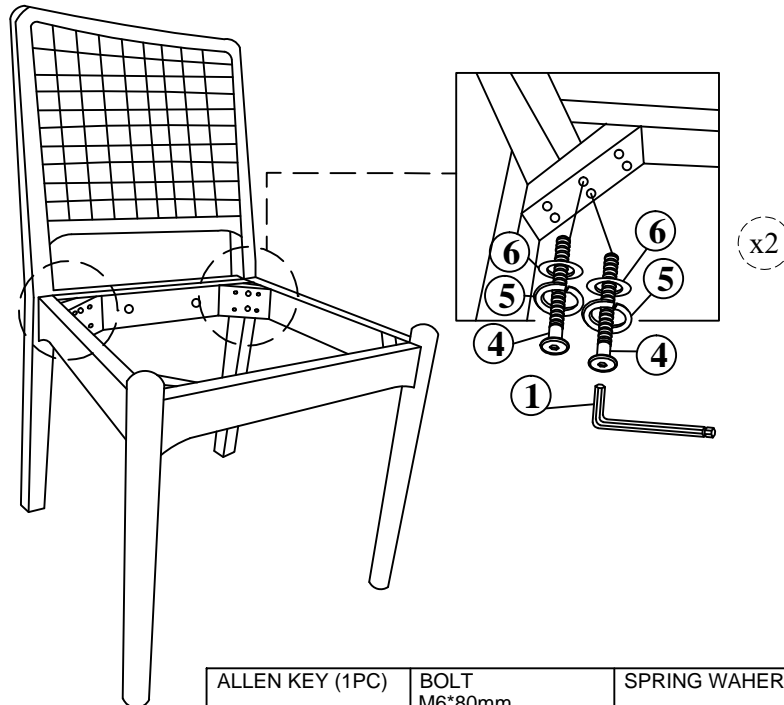

ASSEMBLY INSTRUCTION

ITEM : WF324791

STEP 3



NOTE : Do not fully tighten the bolt

ALLEN KEY (1PC)	BOLT M6*80mm	SPRING WAHER	FLAT WASHER
			
① x 1	④ x 4	⑤ x 4	⑥ x 4

STEP 4

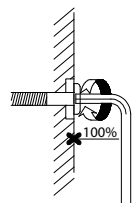
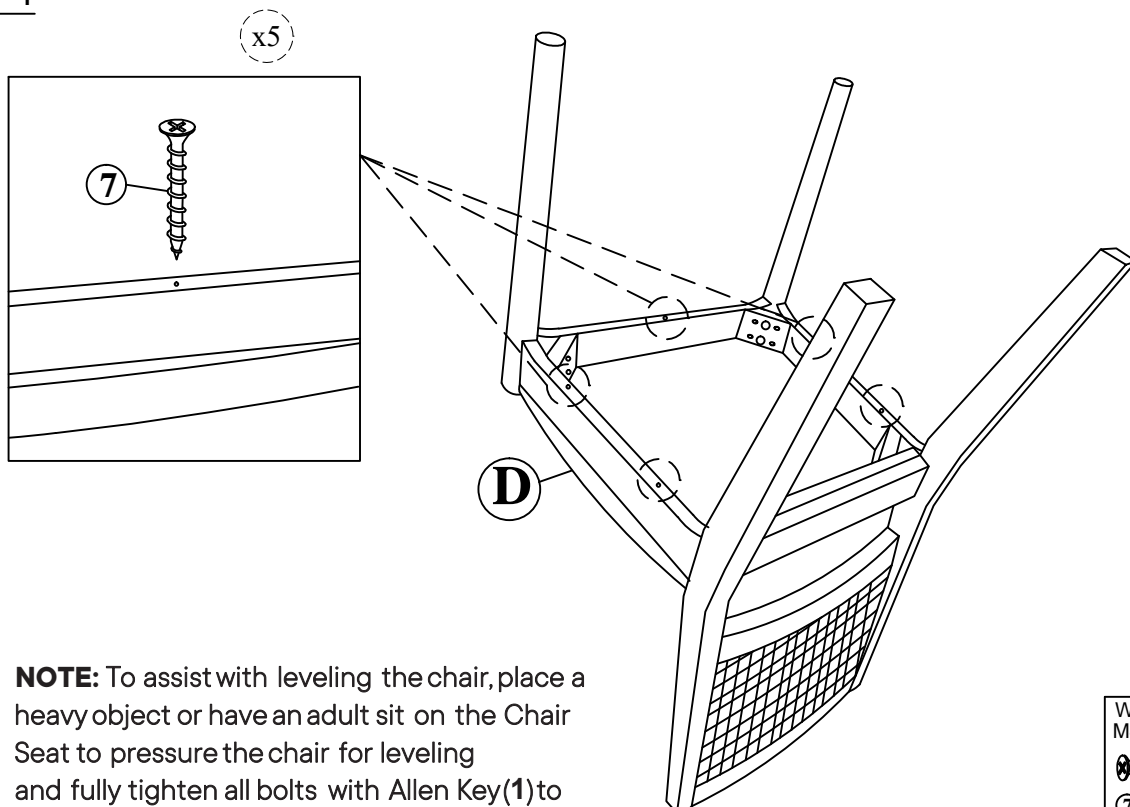

NOTE: To assist with leveling the chair, place a heavy object or have an adult sit on the Chair Seat to pressure the chair for leveling and fully tighten all bolts with Allen Key(1) to secure all legs.

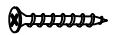
WOOD SCREW M4*32mm

⑦ x 5

ASSEMBLY INSTRUCTION

ITEM : WF324791

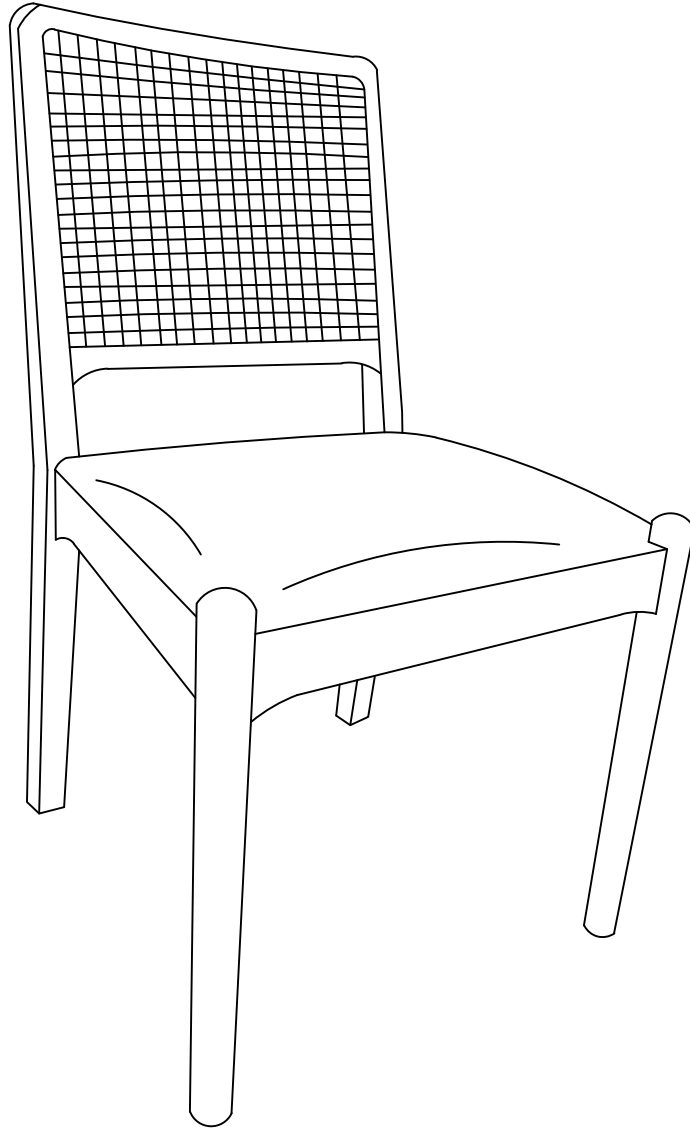
COMPLETE



ASSEMBLY INSTRUCTION

ITEM : WF324790

DINING TABLE

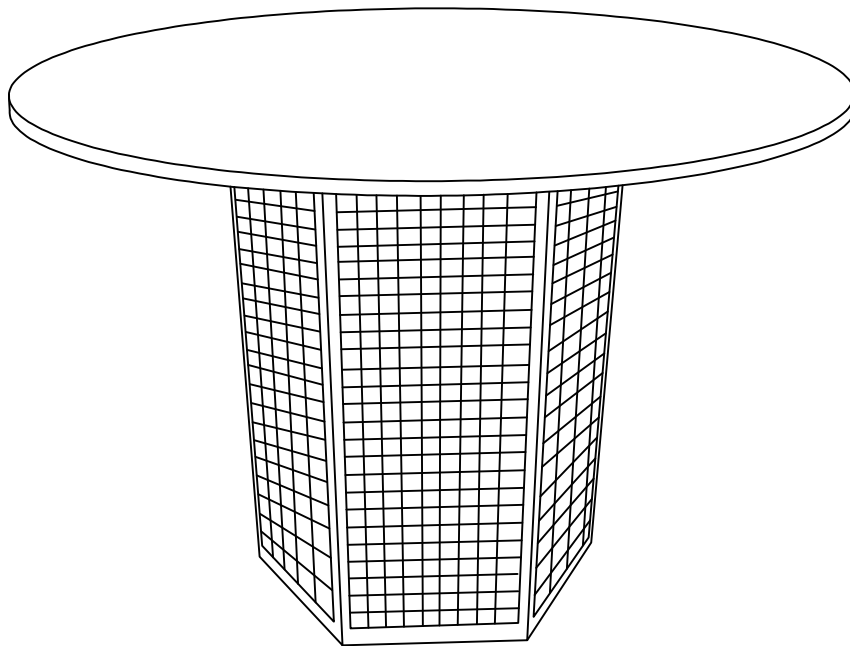

ASSEMBLY INSTRUCTION

ITEM : WF324790

Important Note !

Please read these instructions fully before starting assembly:

1. Place all wooden parts on a clean and smooth surface such as a rug or carpet to avoid scratching the parts
2. Kindly follow the assembly instructions step by step.
3. Do not tighten all screws and bolts until the table is fully assembled.
4. Unscrew the protective plastique supports from the metal insert of the table legs before assembly.
5. Parts of the assembly will be easier with 2 people.

Care and maintenance:

Only clean using a damp cloth and mild detergent, do no use bleach or abrasive cleaners.





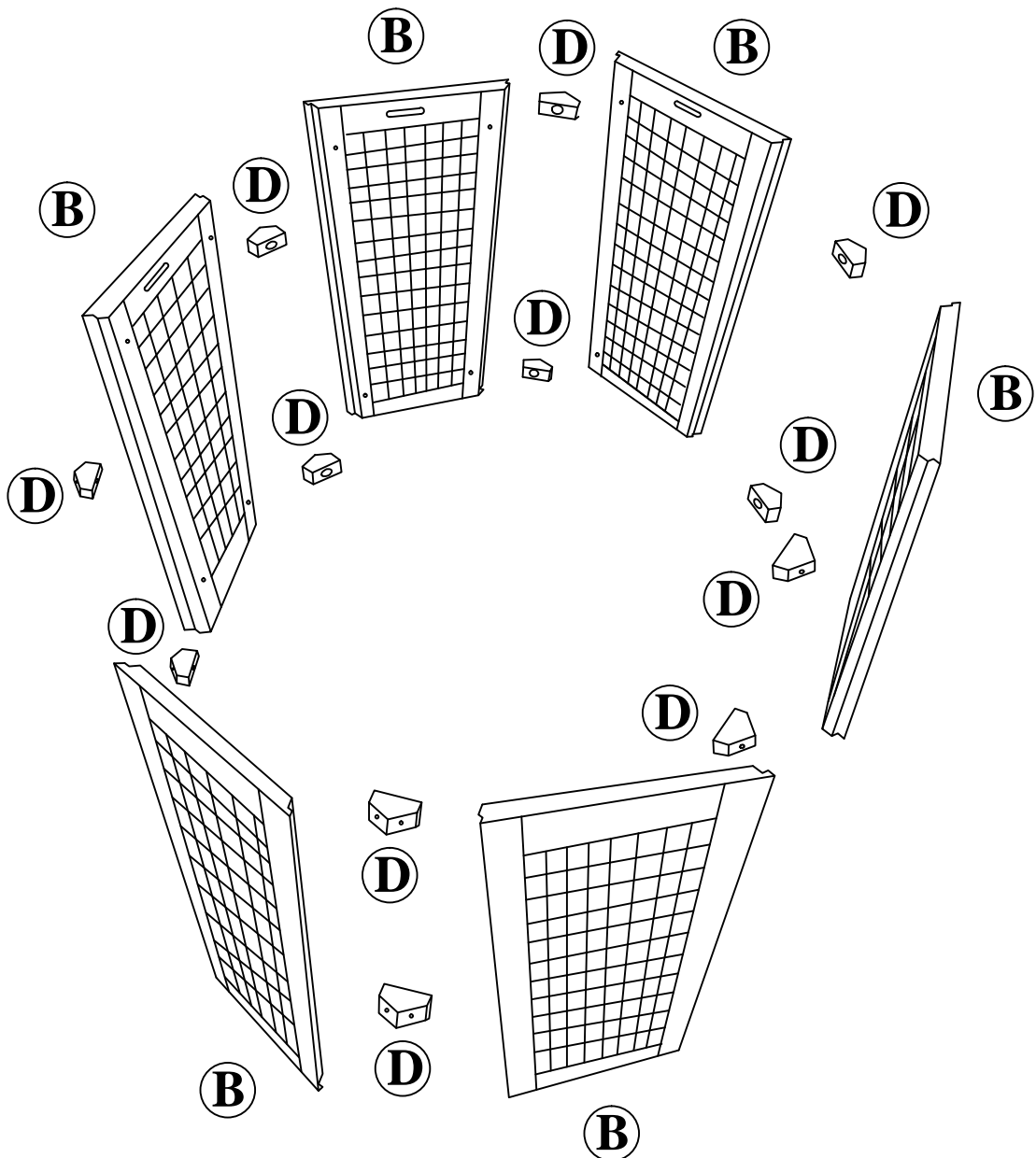
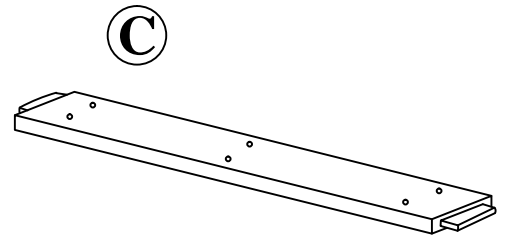
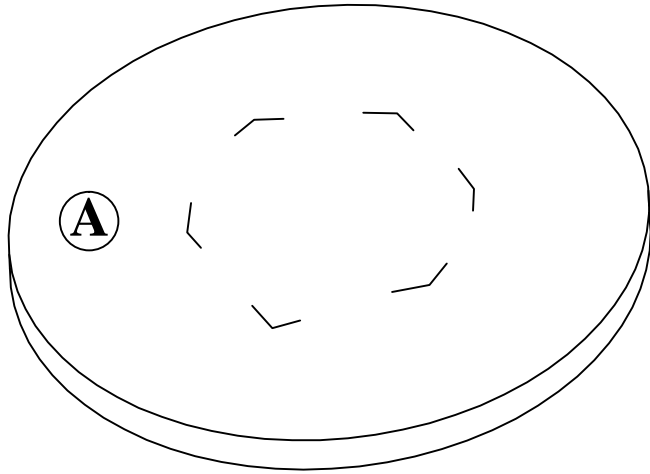

ASSEMBLY INSTRUCTION

ITEM : WF324790

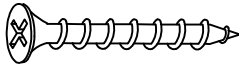
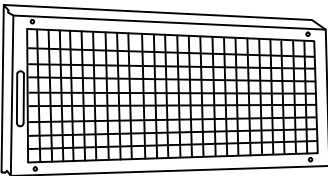

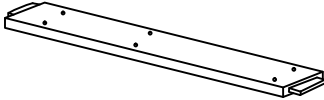
ASSEMBLY INSTRUCTION

ITEM : WF324790

Part List For One	Hardware List For One
<p>A</p> 	<p>1</p>  M4*32mm
<p>TABLE TOP (1PC)</p>	<p>WOOD SCREW (6PCS)</p>
<p>B</p> 	<p>2</p>  M6*30mm
<p>LEG (6PCS)</p>	<p>BOLT (24PCS)</p>
<p>C</p> 	<p>3</p> 
<p>SUPPORT (1PC)</p>	<p>SPRING WASHER (24PCS)</p>
<p>D</p> 	<p>4</p> 
<p>SMALL WOOD (12PCS)</p>	<p>ALLEN KEY (1PC)</p>

ASSEMBLY INSTRUCTION

ITEM : WF324790

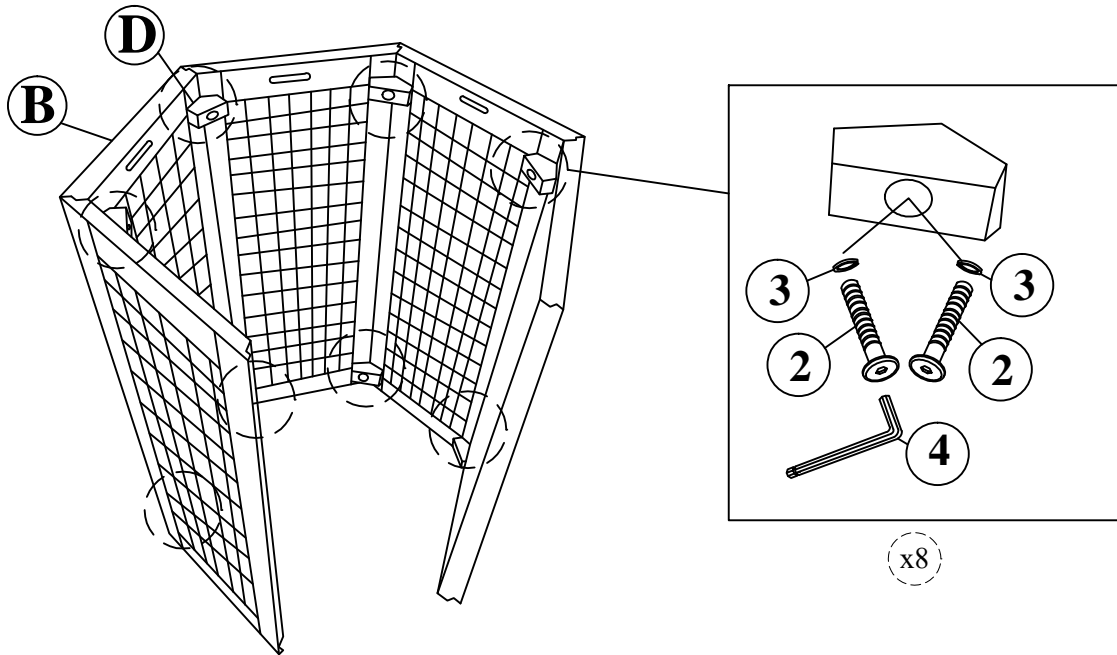

STEP 1

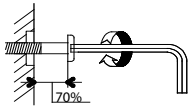

WARNING: Please install the parts with care and on a clean surface.





NOTE : Do not fully tighten the bolt

BOLT M6*60mm  ② x 16	SPRING WAHER  ③ x 16	ALLEN KEY (1PC)  ④ x 1
--	--	--

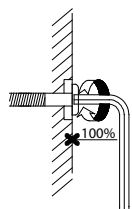
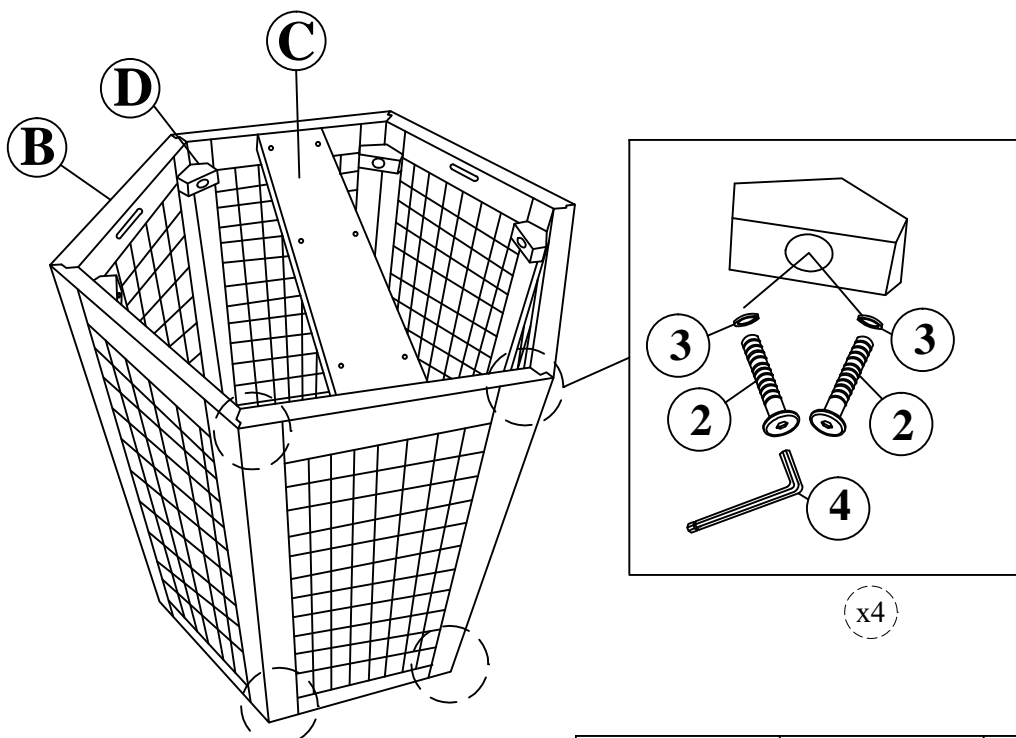
STEP 2



NOTE : Fully tighten all bolts with Allen Key (4) to secure all legs.

BOLT M6*60mm  ② x 8	SPRING WAHER  ③ x 8	ALLEN KEY (1PC)  ④ x 1
---	---	--

ASSEMBLY INSTRUCTION

ITEM : WF324790

STEP 3

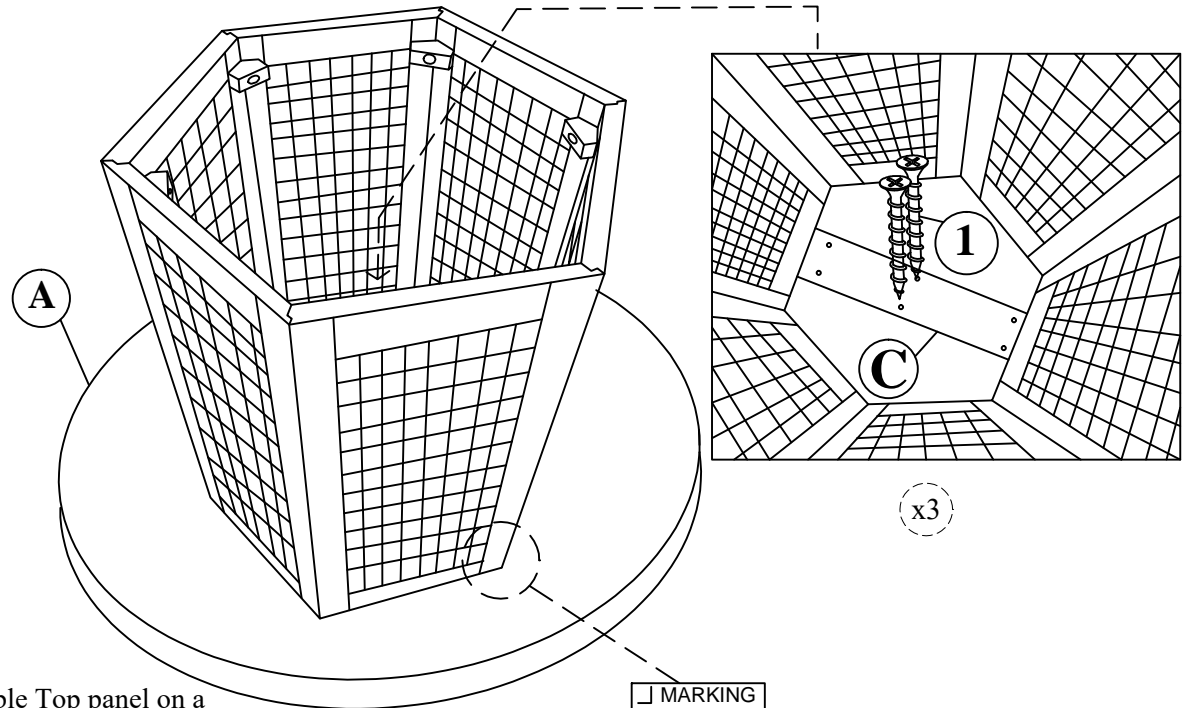

WARNING: Place the Table Top panel on a clean and smooth surface to avoid scratches!

- * There are no pre-drilled holes on the table , please align the legs with the marking line provided and screw directly with screwdriver or electric drill.

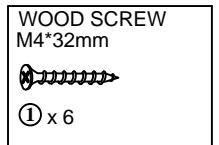

COMPLETE

