

Dimension/Specification

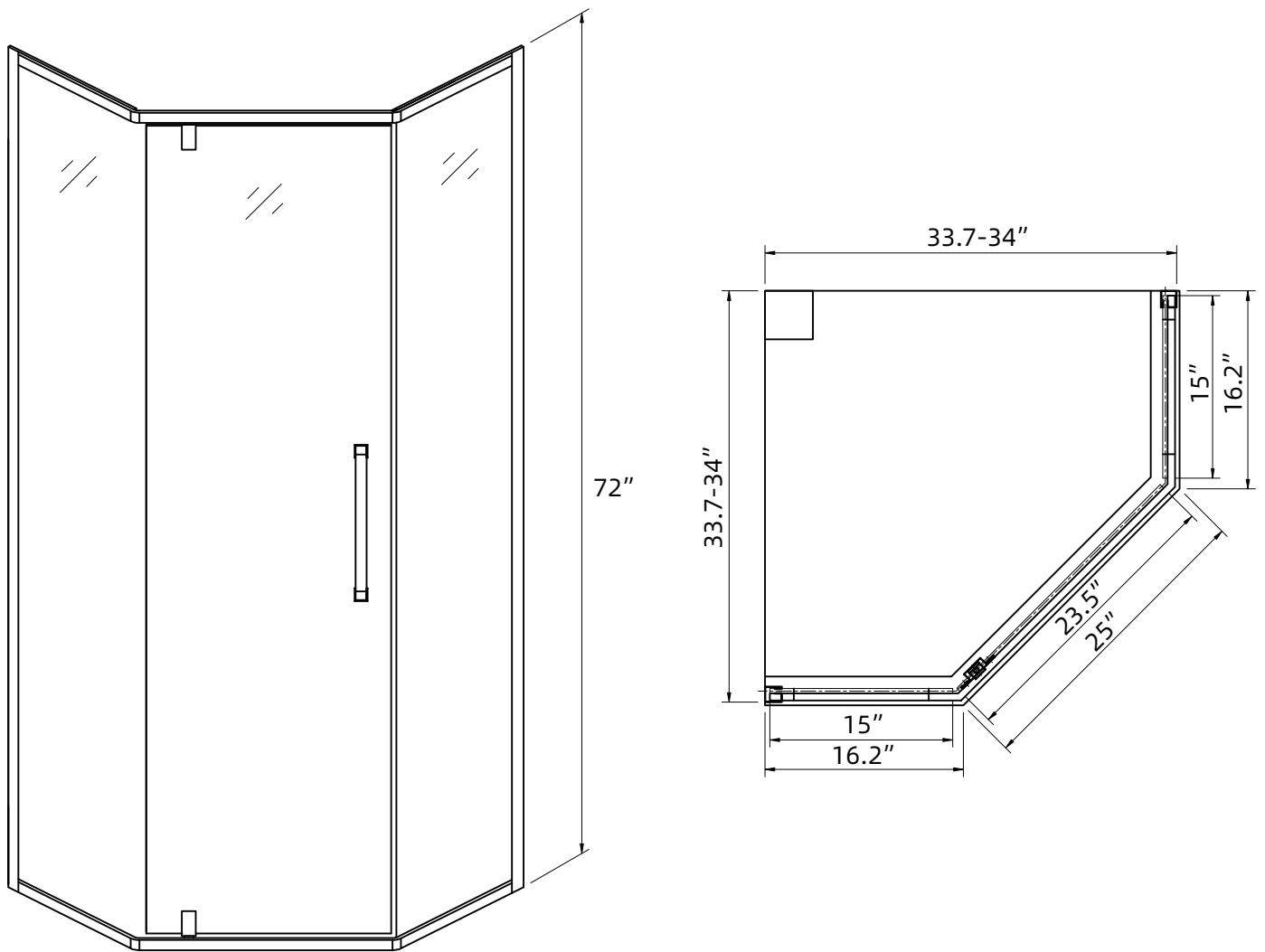

RX-SD06-3472BN