

As this item contains many parts, please read the installation instruction carefully before installation . Please use tools properly and carefully. If you have any questions about the product and installation

Our professional after-sales team will serve you online all day.

Before You Start

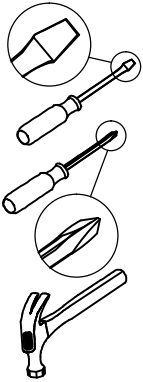

- ✓ Read through each step carefully and follow the proper order
- ✓ Separate and count all your parts and hardware
- ✓ Give yourself enough room for the assembly process
- ✓ Have the following tools: Flat Head Screwdriver, #2 Phillips Head Screwdriver and Hammer
- ✓ Caution: If using a power drill or power screwdriver for screwing, please be aware of to slow down and stop when screw is tight. Failure to do so may result in stripping the screw. (Assembly speed can be increased by using electric screwdriver)

Helpful Hints

PEOPLE NEEDED FOR ASSEMBLY: 1-2

- Open your item in the area you plan to keep it to avoid excessive heavy lifting.



- Identify, sort and count the parts before attempting assembly.

- Compression dowels are lightly tapped in with a hammer.



- Slides are labeled with an **R** (right) and **L** (left) for proper placement.



- Make sure to always face the point on the top of the Cam Lock towards the outer edge.

- If there is a back panel in the package, please install it to make sure your unit is complete and sturdy.



- Please fix all the screws provided for the back panel which can enhance product stability. If it is difficult to fix it when tightening, it can be fixed with the help of a hammer and then tightened.



- Do NOT use harsh chemicals or abrasive cleaners on this item.



- Never push, pull, or drag your furniture.

Board Identification

Not actual size

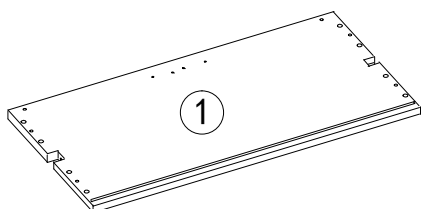

Top
Qty:1

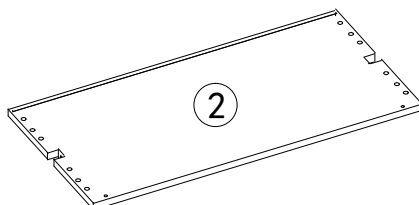

Bottom
Qty:1

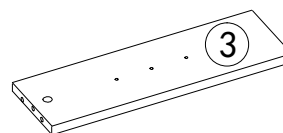

Front Side Panel
Qty:2

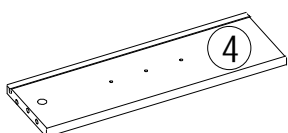

Left Side Panel
Qty:1

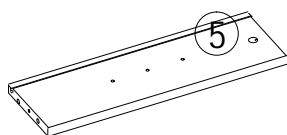

Behind Right Side Panel
Qty:1

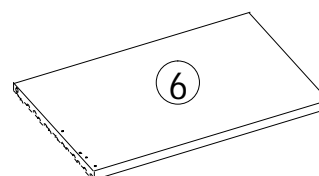

Left Door
Qty:1

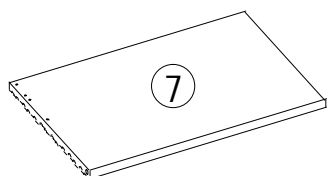

Right Door
Qty:1

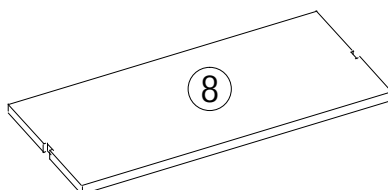

Movable Shelf
Qty:1

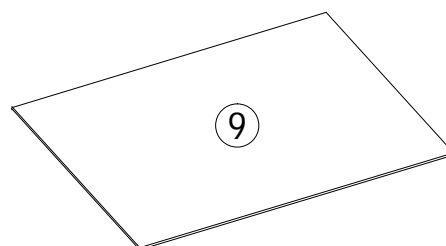

Back Panel
Qty:1

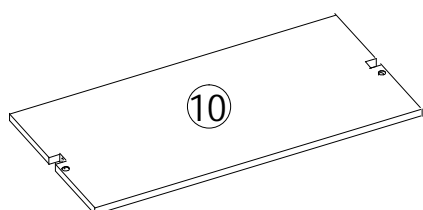

Shelf 1
Qty:2

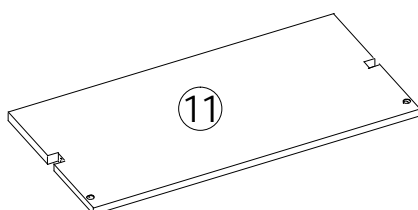

Shelf 2
Qty:1

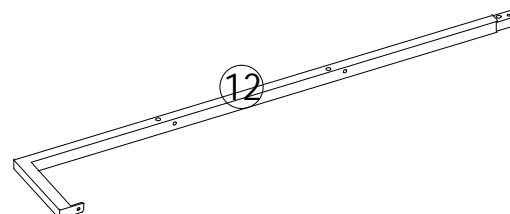

Upper Left
Qty:1

Board Identification

Not actual size

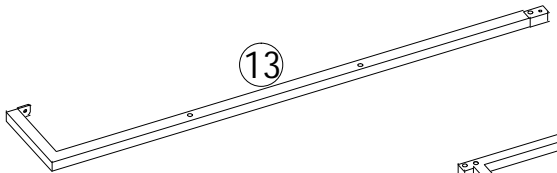

Upper Right
Qty:1

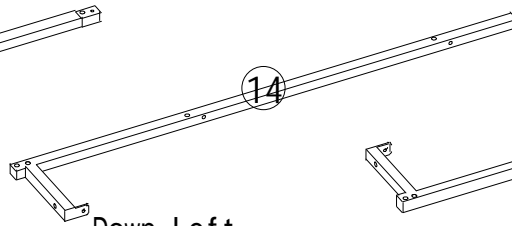

Down Left
Qty:1

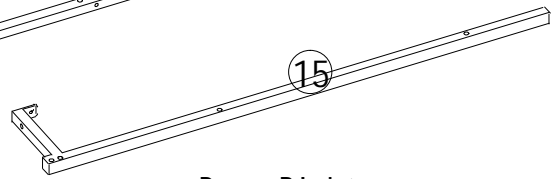

Down Right
Qty:1

Part List

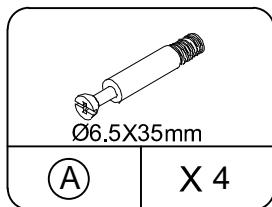

spare: 1

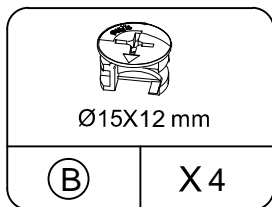

spare: 1

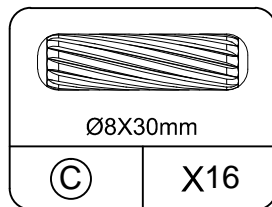

spare: 1

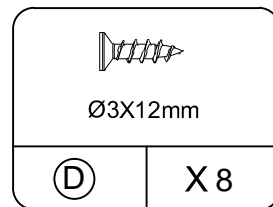

spare:1

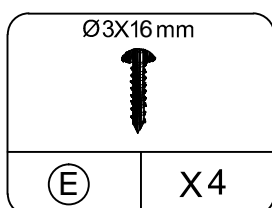

spare: 1

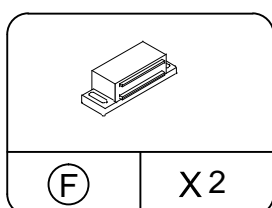

spare:

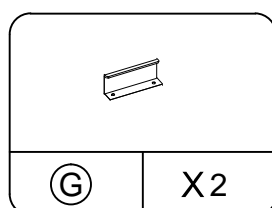

spare:

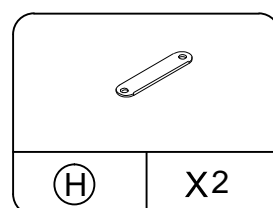

spare: 1

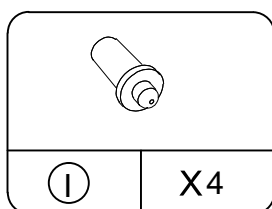

spare: 1

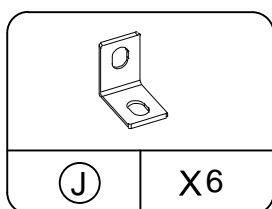

spare:1

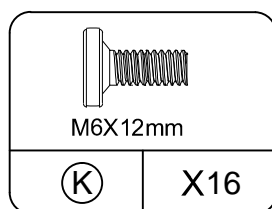

spare:1

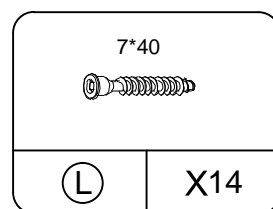

spare: 1

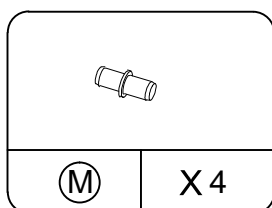

spare: 1

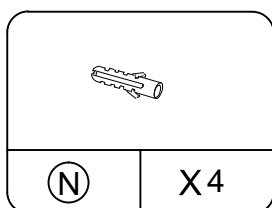

spare:1

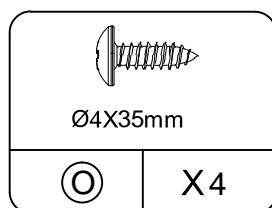

spare:1

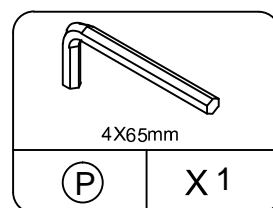

Part List

Cam Lock Fastening System

Insert the cam bolt into the hole first, then insert the cam lock and lock it.

1

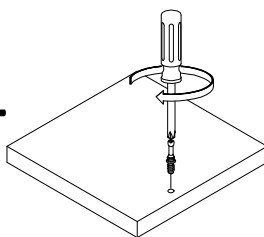

2

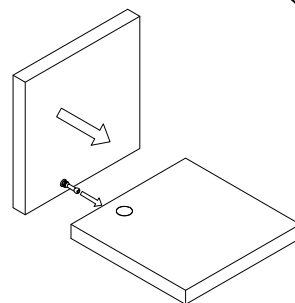

3

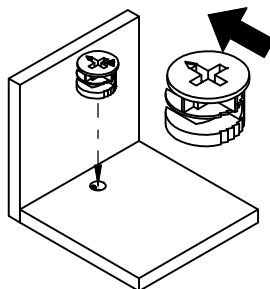

The opening must point toward the edge of the board

4

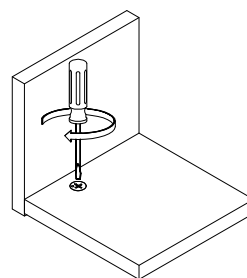

Board Identification

Not actual size

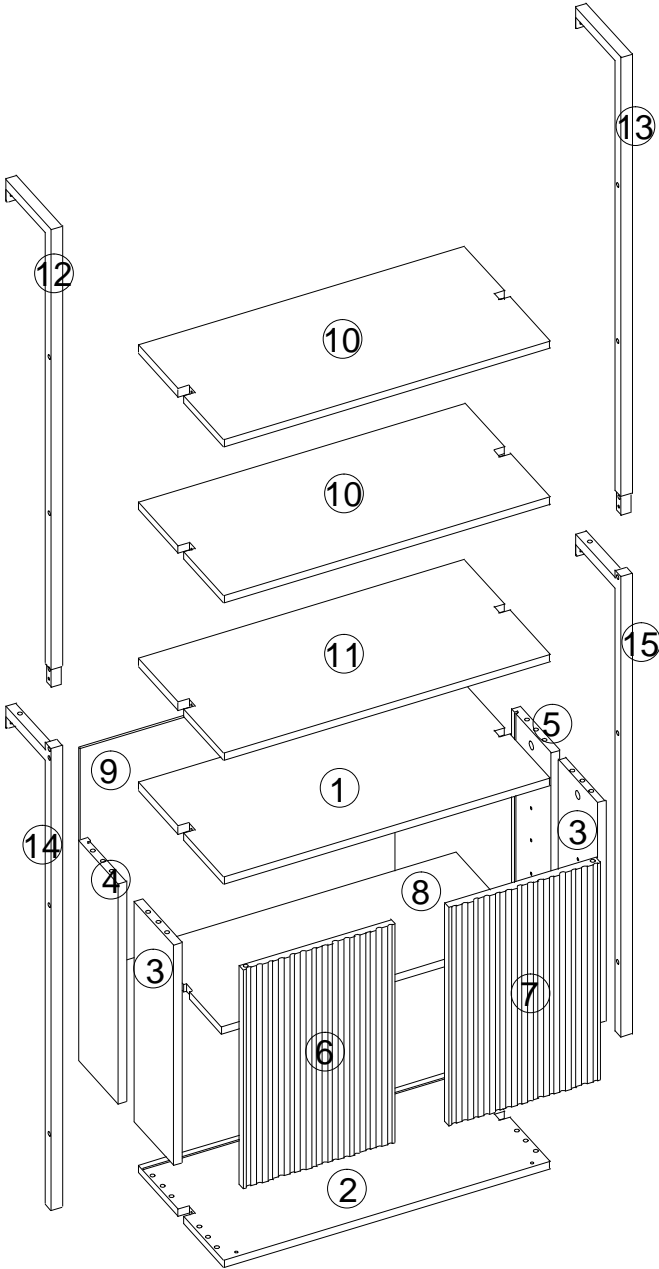

STEP1

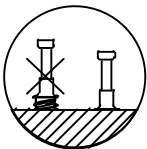
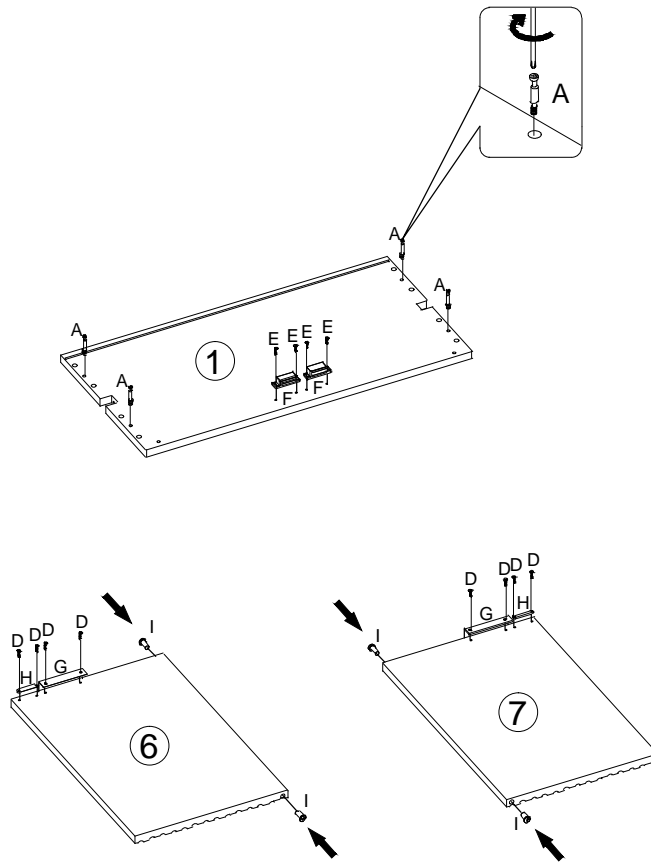
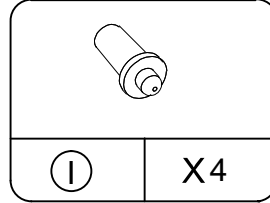
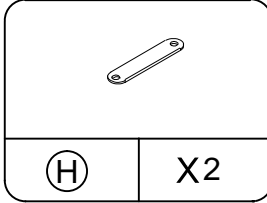
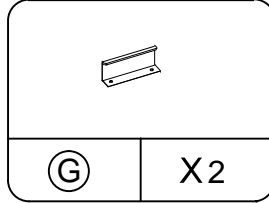
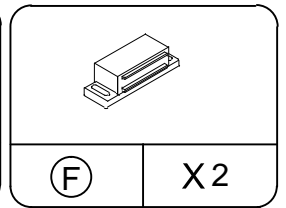
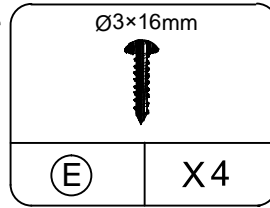
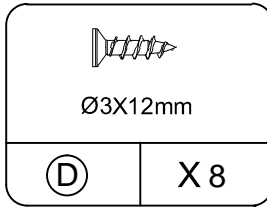
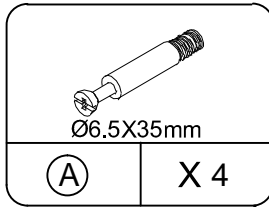
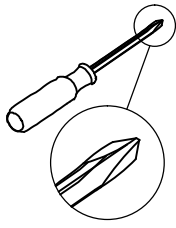

STEP 2

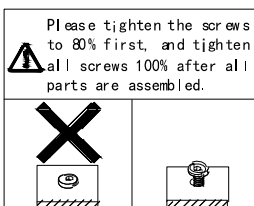
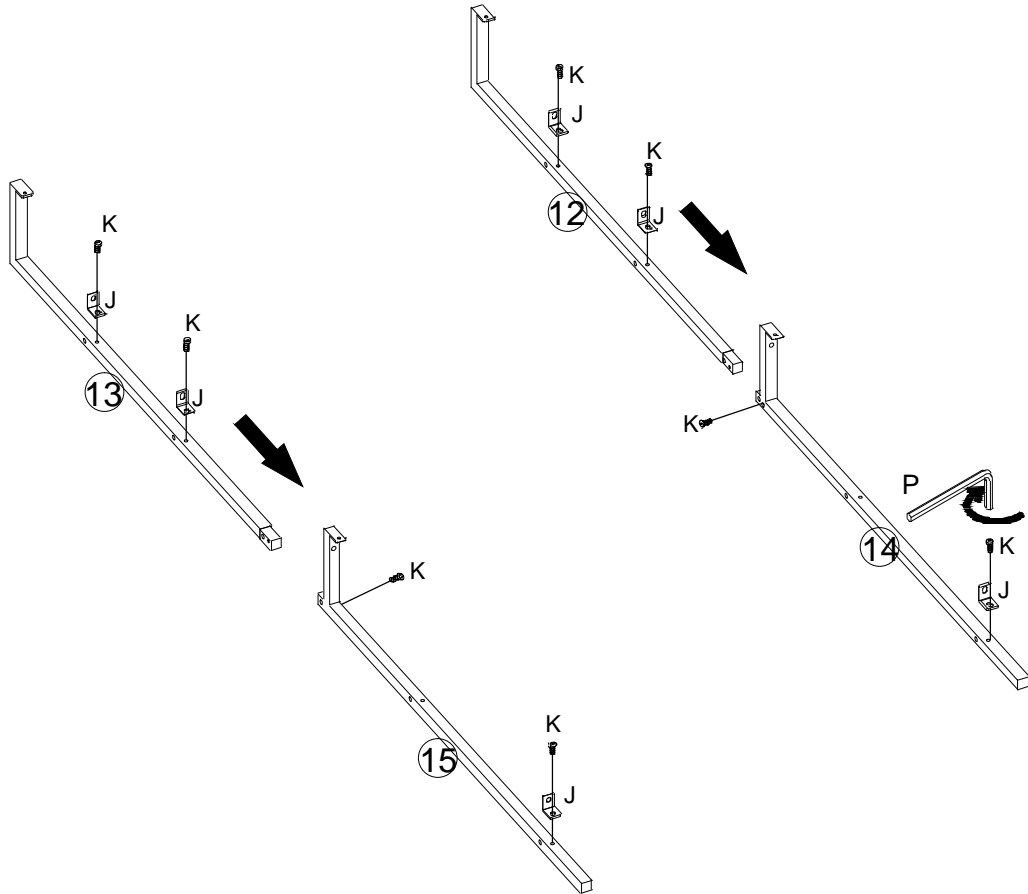
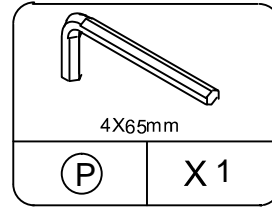
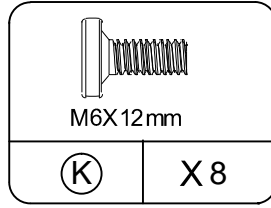
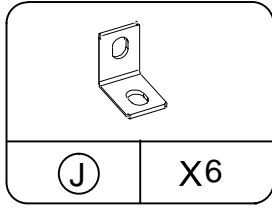
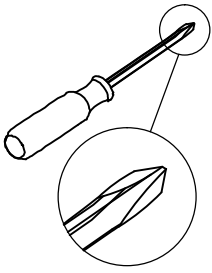

STEP3

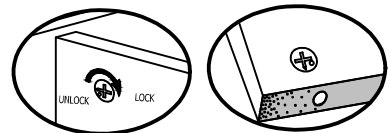
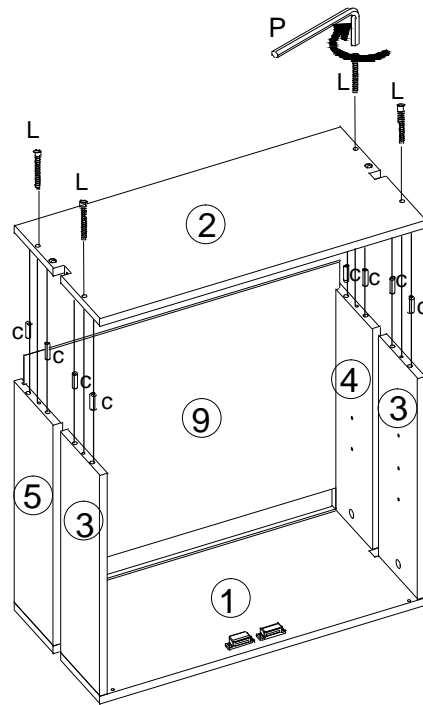
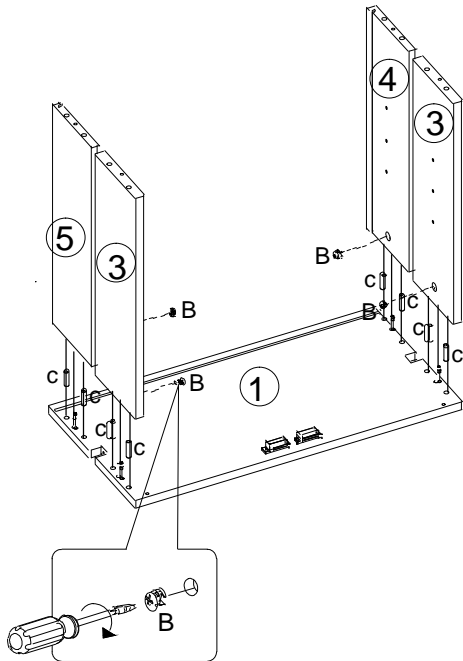
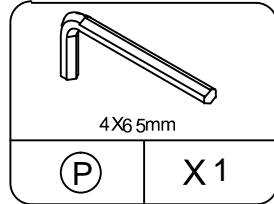
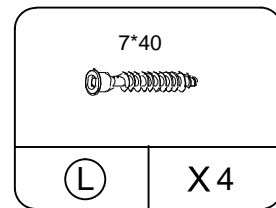
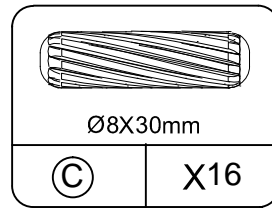
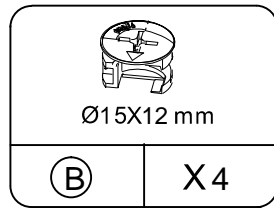
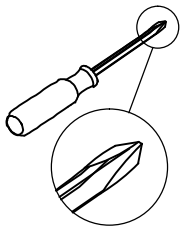

Proper orientation of CAM LOCK

STEP 4

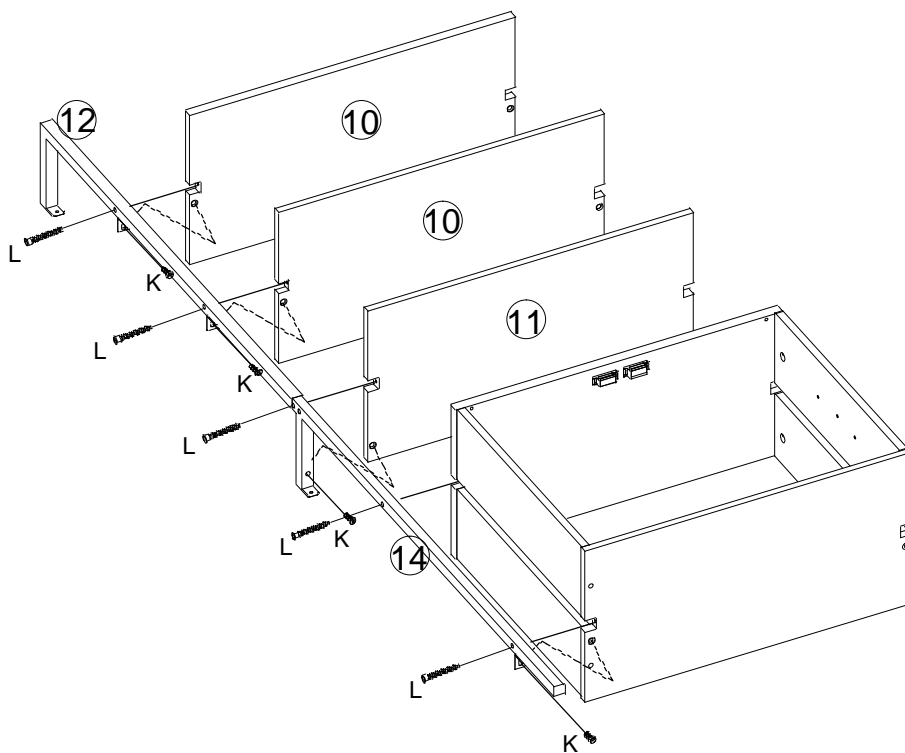
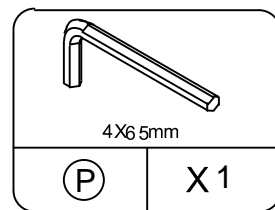
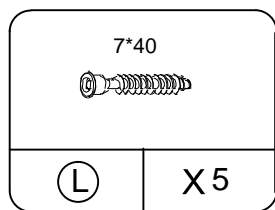
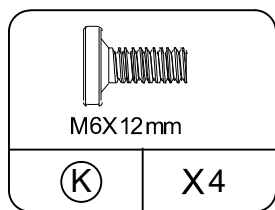
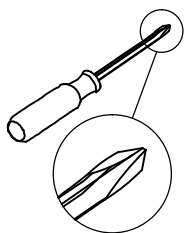

STEP5

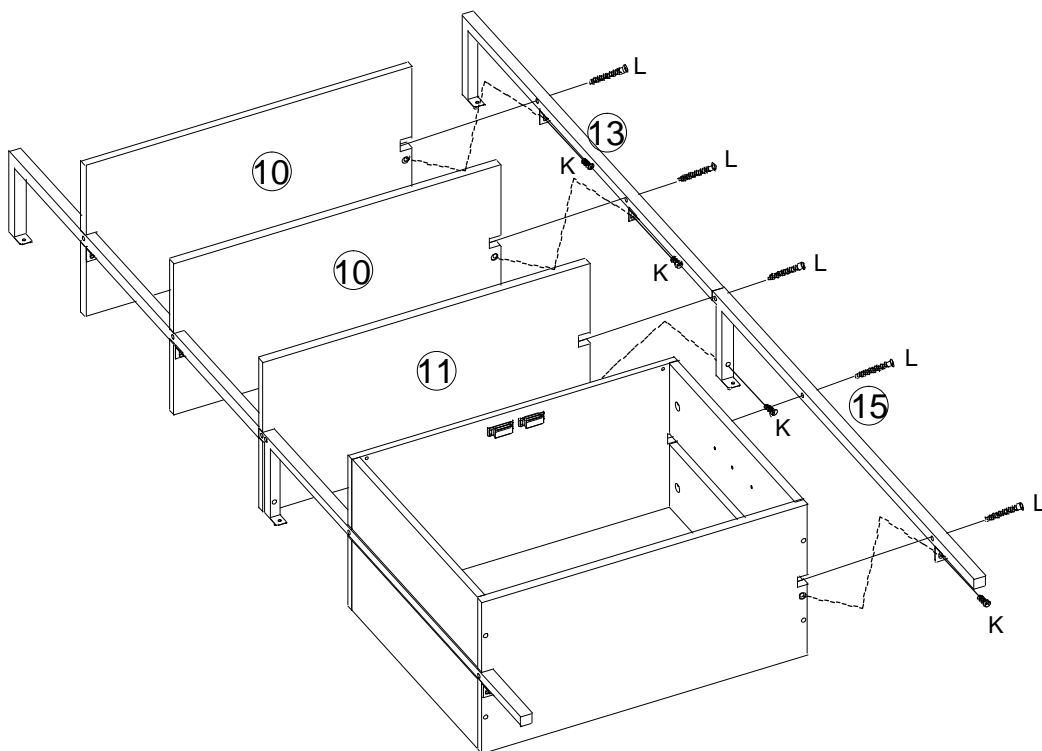
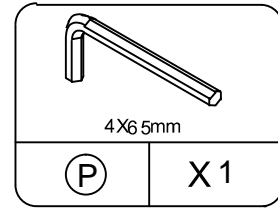
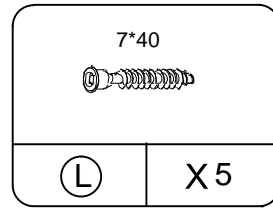
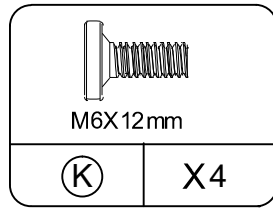
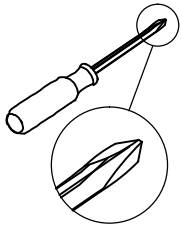

STEP 6

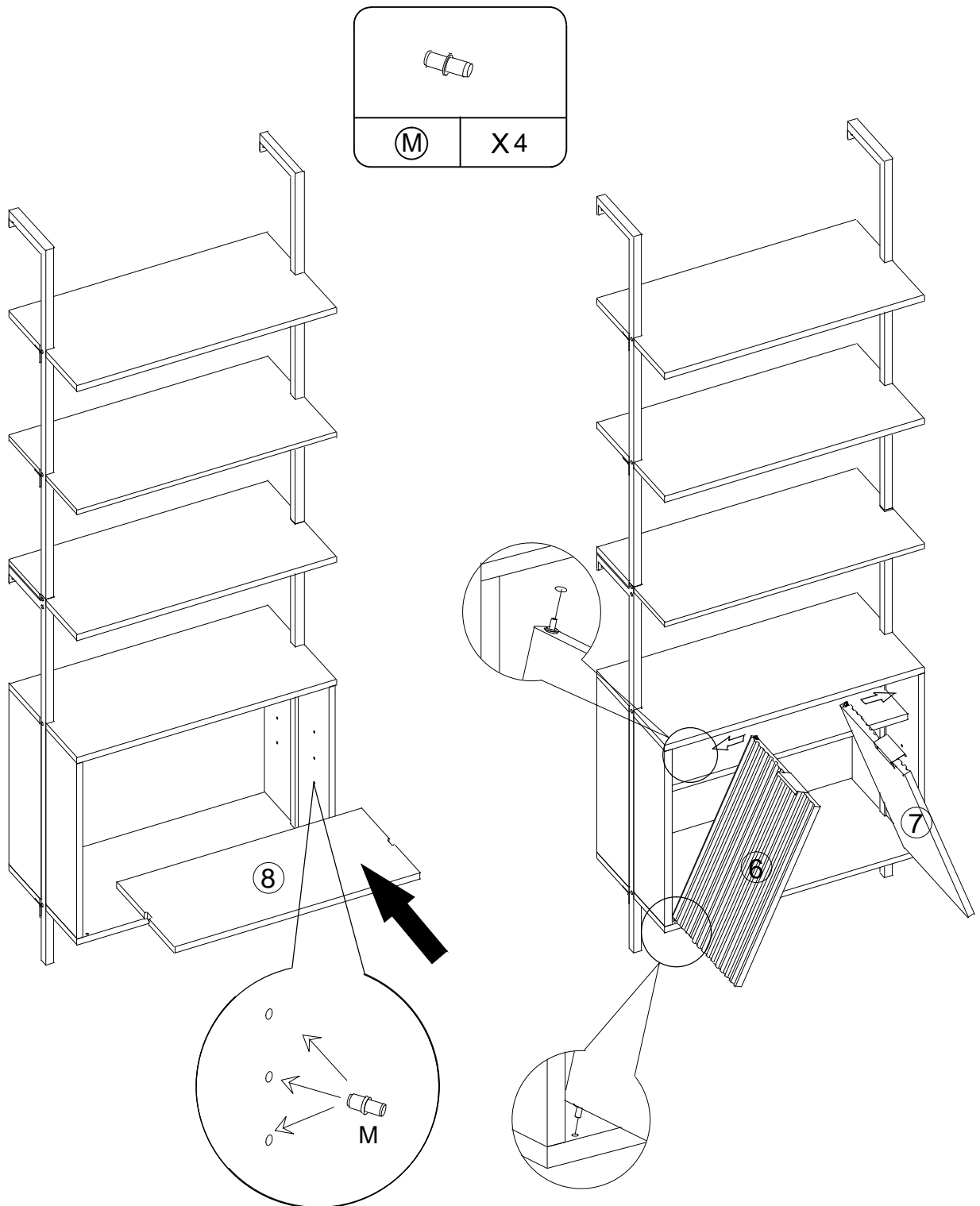

STEP 7

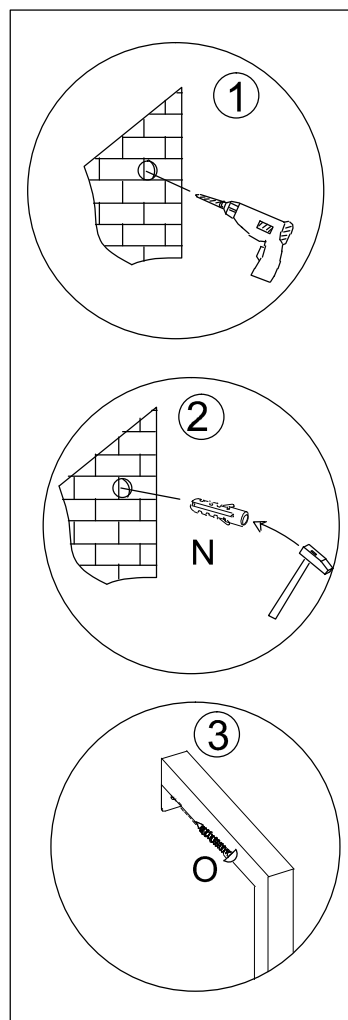
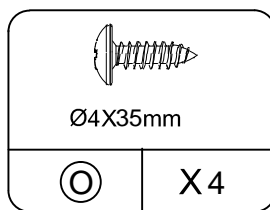
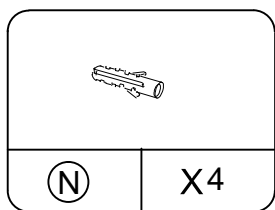
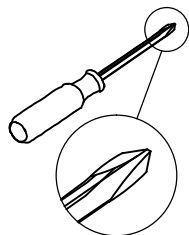

x4

