

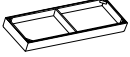





# ASSEMBLY INSTRUCTION

PART LIST			
NO.	PART		Q.TY
A		Seat	1PC
B		leg	4PCS
C		5/16*2"	8PCS
D		5/16"	8PCS
E		5/16*22mm	8PCS
F		5/16*5MM	1PC

## STEP 1

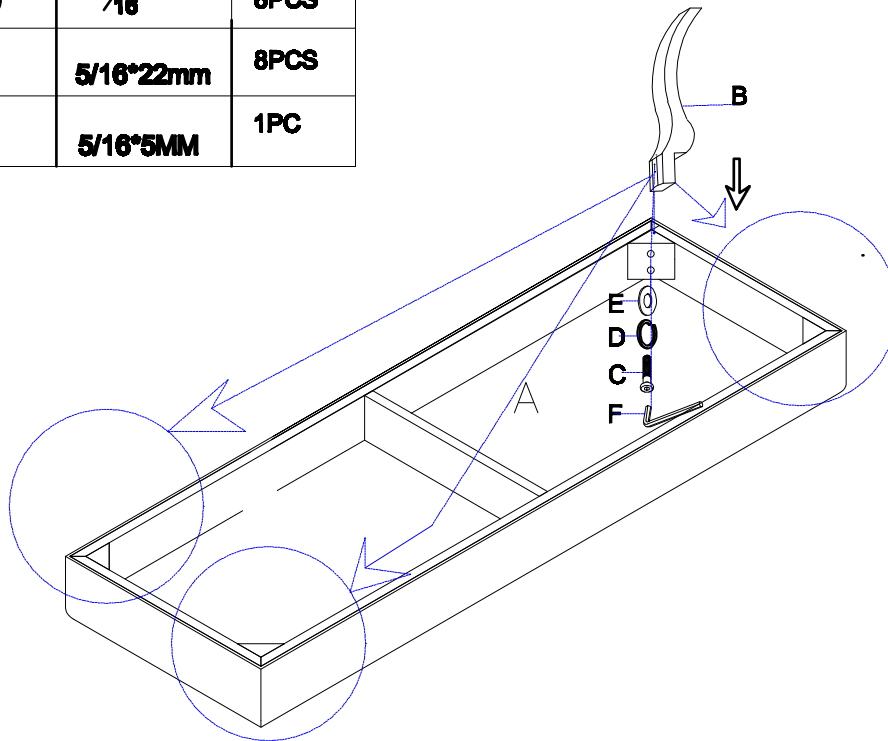

## STEP 2

