

IntelligentToilet
Beyond · Clean · Advanced · Nature

SMART TOILET INSTRUCTION MANUAL

SMT T4

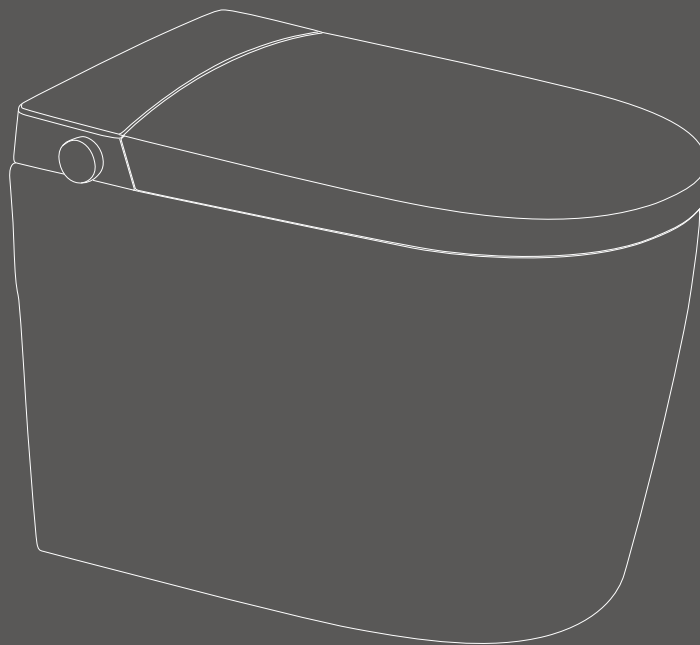

Important: Please read this manual carefully before installation and use.
Follow all warnings and regulations marked in the product manual.

Catalogue

For any questions or support, please email: [\[ysd-wf-after-sale@outlook.com\]](mailto:ysd-wf-after-sale@outlook.com)





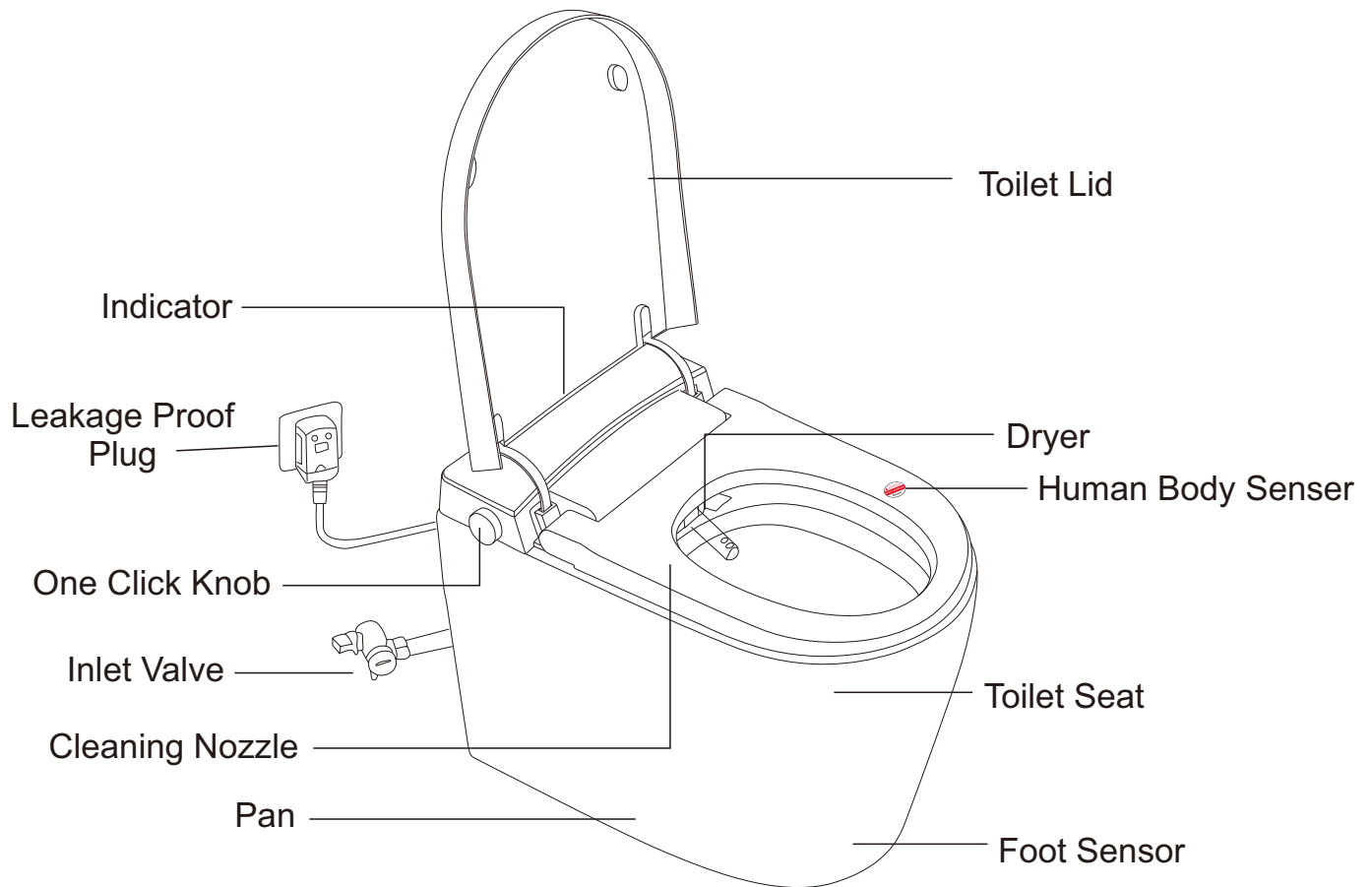



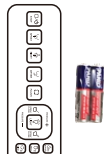

Componet Name - - - - -	02
Safety directory- - - - -	03
Smart toilet initial use inspection items - - - - -	03
Safety Caution - - - - -	04
Safety and Prohibited Matters - - - - -	05
Daily cleaning and maintenance - - - - -	06
Foot sensor user guide - - - - -	06
Side knob instructions- - - - -	07
With Auto Open Cover Flip Remote Control - - - - -	08
Common fault diagnosis - - - - -	10
Installation steps for smart toilet - - - - -	11
Battery replacement and installation - - - - -	15
Product standard - - - - -	16

Componet Name



Hardware List

Please check if all accessories listed below have been received

1pcs	1pcs	1set	1set	1pcs	1pcs	1set	1pcs	1set	1pcs
									
flange ring	Instruction manual	remote control	valve	backup battery	fixed disk	fixed disk screws	7/8" to 3/4" adapter	fixing screws of seat cover	Adapter installation card
A	B	C	D	E	F	G	I	J	K

Warning-To avoid electric shock

1. Do not place the product where it may get wet.
2. Do not drop the remote control into the water.
3. Do not spray water into the product or plug.

Warning: To prevent the possibility of burns, electric shocks, fires and injuries.

1. Young children, temperature insensitive users, when using this product, should be accompanied by others. And turn off or lower the seat temperature.
2. Only use the product for the functions described in this manual, do not use other equipments.
3. Do not continue to use when the product is out of order, damaged or flooded. Please send the product to the designated repair center for repair.
4. Please make sure that the wires are not damaged by burning.
5. Do not use this product when you are out of your mind.
6. Do not plug the product or pipe.
7. Do not used outdoors.

Smart toilet initial use inspection items

Note: To ensure the normal use of the product, please follow the instructions to text.

1. Insert the power plug into the AC 110V socket
2. Please confirm whether the indicator of the digital display panel is lit
3. Confirm whether the inlet valve is take on
4. Whether the hose between the wall Angle valve and the toilet inlet valve is installed in place

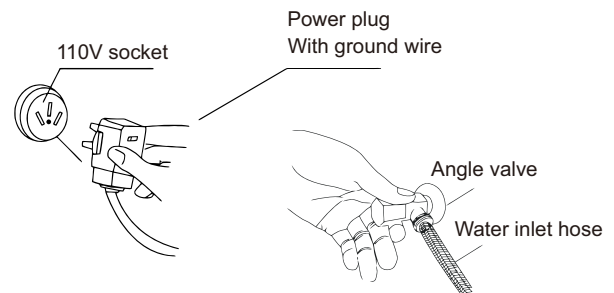

Caution-Confirmed matters before using

1. Check whether the sprinkler head and water pipe leak, dry all parts of the water pipe and check with blotting paper.
2. Press the seat around the seat sensor, whether there is a sound.
3. Check whether the cleaning, drying, and automatic flushing are normal
4. Whether the Damped structure is normal.

Seating sensing position

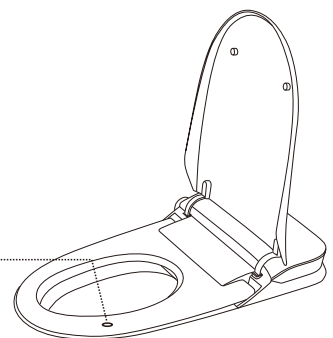

Check the functions of cleaning, drying, make sure the sensor is on. When cleaning, cover and block the spray nozzle, so as not to splash.

Safety Caution

Note: please cautiously read before using

Please read carefully before using. The cautions listed here are related to safety and please follow. 

This product is an electrical product. Please do not install it in a place where it is easy to be splashed by water or high humidity. When using in the bathroom, please install a vent to keep good air flow in the bathroom.

The socket for power distribution should be set as follows

- The gearing position of electric outlet please to give examples 0.3 min the ground above, and leave bathtub as far as possible a little bit farer.
- The back track of electric outlet please use a high feeling and rapid type electric leakage switch (the sum certainly responds the electric current 15 mA following) or use to insulate the transformer 1.5 KVA above, the 3 KVA is following)carry on a protection.

Warning - Be sure to firmly connect ground wires 

The power plug of this product is a three-phase plug (with ground wire). There is a danger of electric shock when there is a fault or leakage of electricity. If there is no ground plug in the socket, consult with the electrical installation company. Do not use power supply other than AC 110V, please wiring according to relevant regulations.

 The product connects a ground of line to carry on to connect a ground of processing, if has never carried on to connect a ground of processing, may arouses to get an electric shock.

Note: the grounding treatment mentioned here means that the grounding resistance is below 100Ω, and the grounding wires of the switchboard shall be copper wires with a diameter of more than 1.6mm.

While using in the bathroom please confirm the power plug have already used silica gel to carry on a waterproof processing.

Using the wrong power supply can easily cause fire

Please be sure to observe the following 

Please don't sprinkle urine at the essence and spray.
Pull out the plug when it thunders.
Strictly forbid to directly flush with water.
Please do not wipe seat and cover with dry cloth or toilet paper.

Please do not open the seat ring or cover violently.
- May cause cracking or malfunction.



Please take antifreeze measures to prevent damage caused by freezing.



Please do not put heaters near this product.
- Discoloration or malfunction will occur

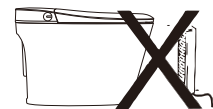

Please read carefully before using.
The cautions listed here are related to safety and please follow.



Must obey

Notice heat burn

- Please turn the seat temperature down or off when sitting on the toilet for a long time.
- Please set the temperature to room temperature when the following persons use the seat to dry gently.

- Children, the elderly, the sick, the disabled, etc.
- People who take sleeping pills, get drunk and get overtired.

Do not use any power source other than AC 110V

- It may start a fire

Keep cigarettes and other fire kindling away from the product

- It may start a fire

Do not use loose and unstable power sockets

- It may cause fire or electric shock

Please don't sprinkle water or rinse on product essence or the power plug.

- May arouse a fire or get an electric shock
- May cause toilet break, damage or indoor seepage.

When long time didn't use, please pull out the power plug.

- For safety, please pull out the power plug
- For re-use, please drain water for one minute before use.

Please do not flush other items except for urine and feces

- May cause then block, sewage outside overflows.

Do not unplug the power plug with wet hands

- It may cause electric shock

Do not distort or damage the water inlet

- It may cause a leak



Prohibit

Do not continue to use the product when it breaks down

When the following occurs, please unplug the power plug, close the inlet Angle valve, stop the inlet.

- Ceramic WC is leaking
- Cracks appear
- Abnormal sound and smell
- Fume-off
- Abnormal heating
- The toilet is clogged

- If continued under the condition of failure, it may cause fire, electric shock or indoor seepage problems

Do not disassemble, repair or transform the product without permission

- It may cause a fire or electric shock

Do not install this product in damp places such as bathrooms

- It may cause a fire or electric shock

Do not damage the power cord or toilet seat cable

- Don't pull
- Don't process
- Don't heat
- Don't forcibly bent
- Do not place heavy objects on the power cord and toilet seat connection line.

- May cause fire, electric shock or short circuit. If the power supply is damaged, please contact a professional for repair.

Do not use extension wires. otherwise, it may cause a fire or electric shock

- Do not connect wires or use extension cords, which may cause fire and electric shock.

Do not use unhealthy water

- May cause skin irritation and other problems

Daily cleaning and maintenance

Note: During cleaning and maintenance, please be sure to unplug the power supply and power off

Smart toilet cleaning and maintenance methods

Please wipe it with a soft cloth dampened with water

- If the dirt is not removed in time, it will become difficult to clean, please wipe with water sometimes.
- Static electricity will absorb dust, resulting in the product black, dirty, water wipe can prevent the generation of static electricity.
- The ceramic body can be removed from the toilet seat to facilitate cleaning between the toilet seat and the ceramic body.

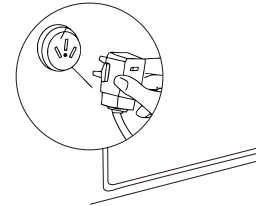

Unplug the power supply before maintenance

Cleaning and maintenance of spray head

If there is dirt in the nozzle. Please clean it with a small brush such as a toothbrush.

- Do not stretch and bend the spray head.

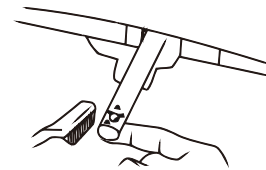

Must obey

Clean the dust on the power plug regularly

When cleaning, remove the power plug and wipe with a dry cleaning cloth.
- Poor insulation may cause a fire.



Must obey

Hip washing, women's washing, and drying require seating before use

Foot sensor user guide

Note: Please read the following carefully before use

Tip: The toilet foot sensor is not sensitive to darker colors or fails to sense. It is recommended to wear light-colored socks and shoes.

Flushing by foot sensor

Put your foot close to the foot sensor to activate the flushing (Manual Seat Version)



Open cover and seat by foot sensor

Close to the foot sensor, automatically open/close cover and seat (automatic flip cover)



Radar automatic flip cover version

The cover opens automatically when people get close to it. The flushing automatically starts after the person leaves the seat, and the cover closes automatically after the person leaves the seat for a while.



Side knob instructions

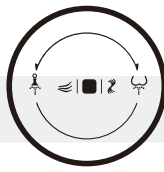

Power on/off: Press (knob) for more than 3 seconds.

Buttocks cleaning: This function requires people to sit down and rotate the (knob) clockwise once, and the (Cleaning Nozzle) will move out to clean the buttocks. Rotate the (knob) again clockwise, and the (Cleaning Nozzle) will move and clean. Buttocks cleaning stops automatically after 90 seconds or press (knob) once.

Female cleaning: This function requires people to sit down and rotate the (knob) counterclockwise once, and the (Cleaning Nozzle) will move out for female cleaning. Rotate the (knob) again counterclockwise, and the (Cleaning Nozzle) will move for cleaning. Feminine cleansing will automatically stop after 90 seconds or press (knob) once.

Stop: After people sit down, press the (knob) once to stop the running functions of buttock washing, female washing, drying and so on.

Toilet flushing: When the person is not sitting down, press the (knob) once to flush.

Warm air drying: This function requires people to sit down and press (knob) twice for warm air drying. The warm air drying will automatically stop after 3 minutes or press (the knob) once. (Tip: It will automatically flush before drying with warm air)

Power failure flushing: Connect the spare battery, press the knob for , 3 seconds during power failure to start flushing.

Description of commonly used special functions

1. Opening/closing of radar (toilet lid automatic opening and closing): Long press the "OPEN COVER" button on the remote control for 3 seconds, Release your hand immediately after hearing the prompt sound (note: the method of opening or closing is the same, if two beeps are emitted, it means it is opened, and if one beep is emitted, it means it is closed)
2. To turn on/off the pre wash function: Long press the "STOP" button on the remote control to turn it off, then long press the "FLUSH" button on the remote control for 3 seconds. After hearing the sound of the toilet, release your hand (note: the method of turning on or off is the same. If two beeps sound, it means it is turned on, and one beep sound means it is turned off)
3. Automatic flushing on/off after leaving the seat: Long press the "FLUSH" button on the remote control for 3 seconds, Release your hand immediately after hearing the prompt sound (Note: The method of opening or closing is the same. If two beeps are emitted, it means opening, and one beep is emitted, it means closing.)
4. Opening and closing of automatic flushing after closing the lid: Long press the "STOP" button on the remote control to turn off the device, then immediately press and hold the "OPEN COVER" button for 3 seconds. After hearing the sound of the toilet, release your hand (note: the method of opening or closing is the same. If two beeps sound, it means opening, and one beep sound means closing)

 **STOP**

Press the (STOP) button to stop running functions such as buttock washing, female washing, and drying.

 **SPRAY/MASSAGE**

This function requires people to sit down, press the (SPRAY/MASSAGE) button, and the (Cleaning Nozzle) will move out to clean the buttocks. Press the (SPRAY/MASSAGE) button again, and the (Cleaning Nozzle) will move and clean, and will automatically stop after 90 seconds clean the buttocks or press the (STOP) button.

 **BIDET/MASSAGE**

This function requires people to sit down, press the (BIDET/MASSAGE) button, and the (Cleaning Nozzle) will move out for female cleaning. Press the (BIDET/MASSAGE) button again, and the (Cleaning Nozzle) will move for cleaning, and will automatically stop after 90 seconds feminine cleansing or press the (STOP) button.

 **DRYER**

This function requires people to sit down, press the (DRYER) button to perform warm air drying. After 3 minutes, the warm air drying will automatically stop or press the (STOP) button. (Tip: It will automatically flush before drying with warm air)

 **CLEANING NOZZLE MOVE FORWARD**

Press this button during the "buttocks" or "female" spray cleaning process to move the cleaning nozzle forward (repeatedly press the button to move the nozzle forward)

 **CLEANING NOZZLE MOVE BACKWARD**

Press this button during the "buttocks" or "female" spray cleaning process to move the cleaning nozzle backwards (press the button repeatedly to move the nozzle backwards)

 **WATER PRESSURE INCREASES**

During the cleaning process of buttocks or women, press the (+) button to increase the water pressure of (Cleaning Nozzle), and it can be adjusted to weak, medium, strong, and strongest.

 **WATER PRESSURE REDUCED**

During the cleaning process of buttocks or women, press the (-) button to reduce the water pressure of (Cleaning Nozzle), and it can be adjusted to weak, medium, strong, and strongest.

 **OPEN COVER**

Press the (OPEN COVER) button and the toilet lid will automatically open. Press the (OPEN COVER) button again and the toilet lid will automatically close.

 **OPEN SEAT**

Press the (OPEN SEAT) button and the toilet seat will automatically open. Press the (OPEN SEAT) button again and the toilet seat will automatically close.

FLUSH

Press the (FLUSH) button to flush the toilet.

WATER

During the cleaning process of buttocks and women, press the (WATER) button to adjust the water temperature of (Cleaning Nozzle). There are 4 levels of water temperature adjustment, the first level is normal temperature, the second level is 93°F, the third level is 96°F, and the fourth level is 99°F.

SEAT

Press the (SEAT) button to adjust the toilet seat temperature, which can be adjusted in 4 levels. The first level is normal temperature, the second level is 93°F, the third level is 96°F, and the fourth level is 99°F.

WIND

During the warm air drying process, press the (WIND) button to adjust the temperature of the (Dryer), which can be adjusted in 4 levels. The first level is normal temperature, the second level is 93°F, the third level is 96°F, and the fourth level is 99°F.

AUTO

Press the (AUTO) button, (Cleaning Nozzle) will move out and water will come out for cleaning, and then you can use a brush or rag to clean (Cleaning Nozzle)

LIGHT

Press the (LIGHT) button, The night light can be turned on or off in the power-on state.

Remote control pairing

If the remote control does not respond when you use it for the first time, you need to code the remote control with the toilet. Rotate (the knob) clockwise for about 3 seconds. After hearing a "beep", press any button on the remote control to complete the code matching.

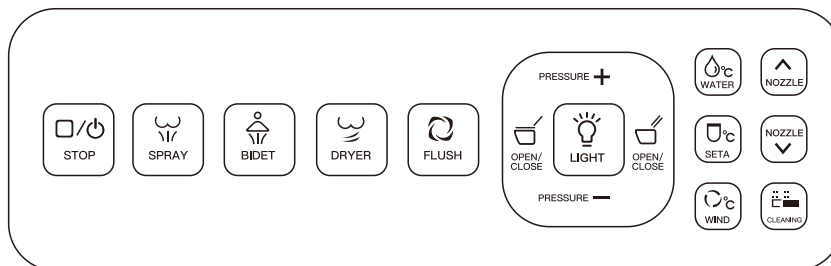

Common fault diagnosis

Note: If similar fault is found, please read the following solution or contact after sales

Fault phenomenon	Fault analysis	Fault handling
Product unavailable	Check to see if the power/socket is loose	Please check the circuit
	Whether there is leakage (the display light of leakage protection plug is not on)	Remove the power plug from the socket and replug it later. Press the reset switch of the leakage protection plug. If the elbow still cannot be operated, please unplug the power plug and entrust the repair.
No water with spray	Check if water is cut off	Pending resumption of water supply
	Check that the Angle valve is closed	Open the Angle valve
	Check if the inlet filter is blocked	Clean or replace the filter
	Check the inlet pipe for bends	Exclude the intake bend
Cleaning insufficient rigidity	Check whether the cleaning pressure is at the lowest level	Refer to the instruction manual for regulating the water pressure
	Check if the inlet filter is blocked	Clean or replace the filter
Spray water disorderly	Abnormal operation	Unplug the plug for one minute and then switch it back on
water temperature is not enough	Check that the water temperature is set low	Adjust the water temperature according to the instructions
	Whether the hot and cold massage function is on	Turn off the hot and cold massage function according to the instructions
The washer often drips water	Solenoid valve failure	Please get professional maintenance technicians
Misoperation of remote control	Check the battery level of the remote control is it too low	Please replace the battery
Drying/seat temperature too low/no heating	Check whether the temperature is set at low or normal temperature	Adjust the temperature according to the instruction
	Whether to turn on the power saving function	Refer to the manual to choose to turn off the power saving function
Seat/ cover falling too fast	Failure of damping drop function	Please get professional maintenance technicians
The cleaning function cannot be used normally	Is there any other hard material holding it under the seat	Remove the hard objects
	Whether the body's sensing area is covered	Adjust the body sensing area of the seat cover
	Whether the power supply is restored during the power failure	Unplug the plug for one minute and then switch it back on
	The skin completely cover the human body induction area of the seat	Sensor failure, please get professional maintenance technicians
Seat/cover cannot be opened or closed * Only for automatic flip machines	Failure of automatic damping function	1. Disconnect the plug for one minute and switch it back on 2. The above treatment is invalid, please ask professional personnel for maintenance
Low water pressure does not flush clean	Filter mist blocking	Clean the filter according to the instruction
	Pipe bending	Observe whether the connection line bends and keep the water supply line smooth
No siphon flushing is not clean when water pressure is normal	Air escapes from the sewage outlet	Please get professional maintenance technicians
	The S-bend is blocked	Please buy water pipe dredger in the market for dredging
Flush is not clean when water pressure normal	Flush valve failure	Ask professionals for maintenance

Due to the different printing time of the materials, the product specifications may be slightly changed. Please refer to the material object.

Installation steps for smart toilet

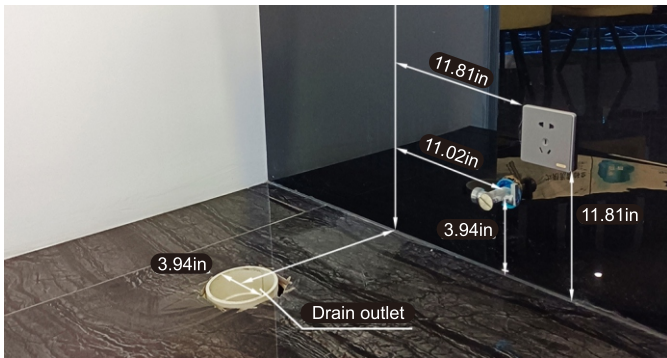

The confirmation of the installation environment



1.The confirmation of the installation environment: The measurement distance is 11.81in or greater



2.Place the fixed disk into the drain outlet and mark the screw hole positions



3.Take off the fixed disk and drill four holes for screws



4.Put the screws into the holes

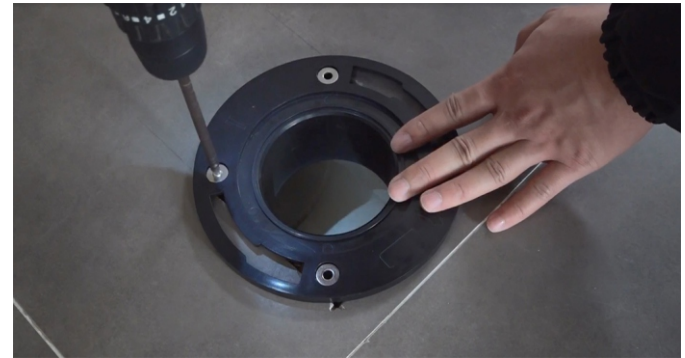

5.Put the flange ring into the drain outlet and install it

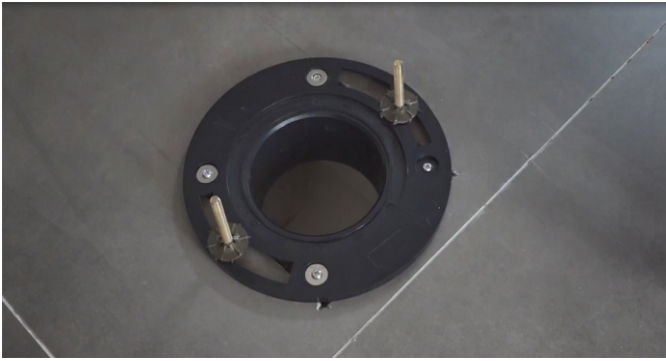

6. Install two long screws as below picture



7. Unscrew the screws on the toilet seat



8. Take off the whole toilet seat and unscrew the flexible tube and black wire



9. Turn over the toilet bowl and install the fixed disk as shown in the figure.



10. Apply a layer of silicone sealant to the base of the toilet. (The glass adhesive in the picture needs to be purchased by oneself.)



11. Move the toilet to the location where it will be installed



12. Make sure two holes in the bottom of the toilet align with the two long screws in the flange ring, then install it



13. Put the toilet seat in the toilet and reconnecting the flexible tube and black wire



14. Install the screws on the toilet seat and put on the fixing



15. Apply some glass glue to fix the toilet and insulate the outside dirt from entering. (The glass adhesive in the picture needs to be purchased by oneself.)

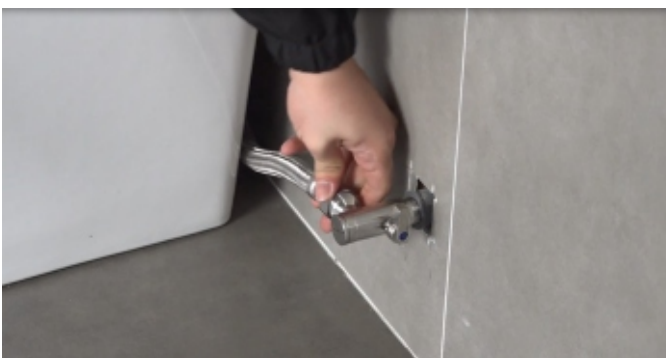

16. Finally connecting the flexible tube to the inlet angle valve

Attention: The above installation steps are universal for all models of toilets and are only for your reference during installation. If you find that the details in the pictures do not match the actual product, please ignore them!

For product assistance, please contact our customer service team at: ysd-wf-after-sale@outlook.com

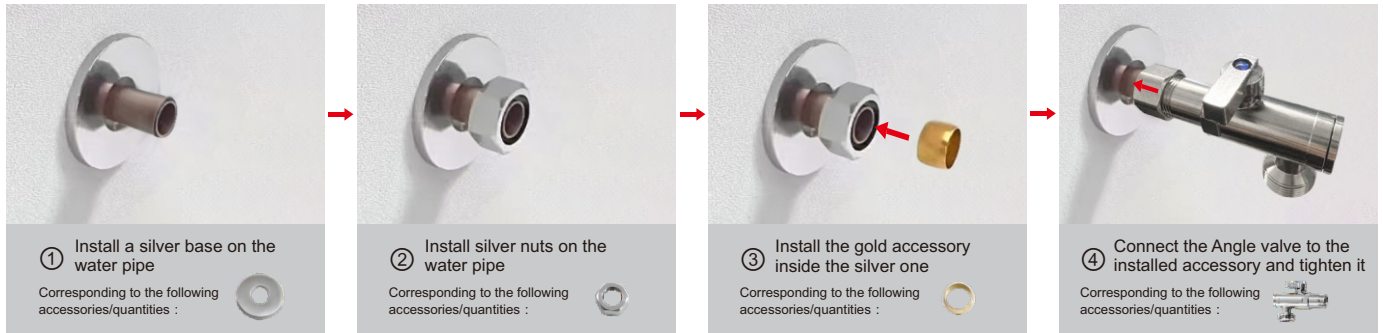

Our angle valve is a standard American-controlled angle valve. If the valve is incompatible with your plumbing setup, please contact us in time. email: ysd-wf-after-sale@outlook.com, we will solve your problem as soon as possible.



17. Finally connecting the flexible tube to he inlet angle valve And turn on the Angle valve switch

Attention: The above installation steps are universal for all models of toilets and are only for your reference during installation. If you find that the details in the pictures do not match the actual product, please ignore them!

Battery replacement and installation

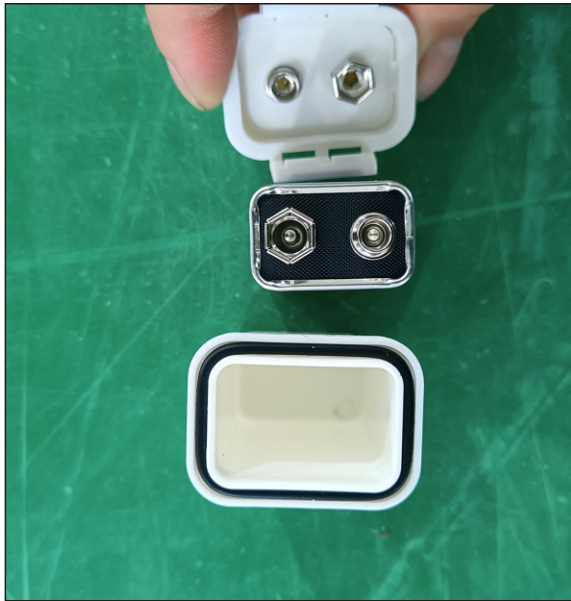

Step 1
Align the positive and negative poles of the battery.



Step 2
Put the backup battery into the device fasten the buckle.



Step 3
Align the backup battery plug hole and tighten the nut.



Step 4
Backup battery device connection ready.

Product standard

Rated voltage	Alternating voltage 110V±10%, 60HZ		
Rated power	Water inlet temperature: 59°F Outlet water temperature: 99°F Water discharge: 750ml/min Power: 1350W		
Cleaning	Water outlet	Hip cleaning	About 700 ml/min
		Female cleaning	About 700 ml/min
	Outlet water temperature		Normal temperature, and 93°F/96°F/99°F(4 grades)
	Water heating		Instant water heater
	Heater power		Water inlet temperature: 59°F , Outlet water temperature: 99°F Water discharge: 750ml/min Power: 1350W
Seat heating	Seat temperature		Normal temperature, and 93°F/96°F/99°F(4 grades)
	Heater power		40W
Warm drying	Wind temperature		Normal temperature, and 93°F/96°F/99°F(4 grades)
Spray position			Adjustable Fore and Aft
Water temperature			41~99°F
Water Pressure (Without Water Tank)			0.15-0.75 Mpa (static) is about 5L of water in 15 seconds

**For product assistance, please contact our customer service team at:
ysd-wf-after-sale@outlook.com**

Note:For the most accurate details, please always refer to the physical product.