

## REMOTE CONTROL INSTRUCTIONS

### REMOTE SIGNAL PAIRING:

If the remote control loses signal of the fan, press and hold the button ⑨ at the very beginning after it's turned on from wall switch. After the fan light flashes or beeps, it's done.

- ①: Turn off power.
- ②: Turn on / off the light.
- ③: Turn on the fan on 1/2/3/4/5/6 speed.
- ④: Fan moves forwards.
- ⑤: 1H for timing the fan.
- ⑥: Natural wind, fan speed will change automatically with this function.
- ⑦: Turn off the fan.
- ⑧: Fan moves reversely.
- ⑨: 2H for timing the fan.
- ⑩: Turn on/off the mute mode.

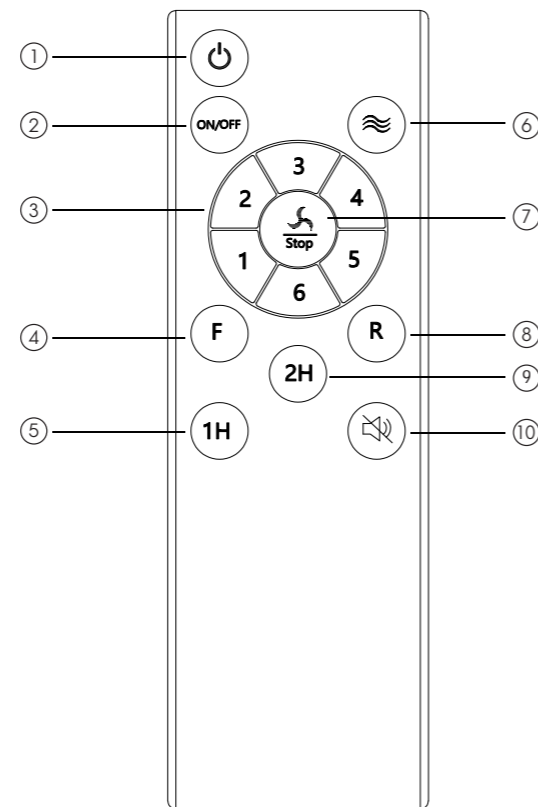

## APP CONTROL INSTRUCTIONS

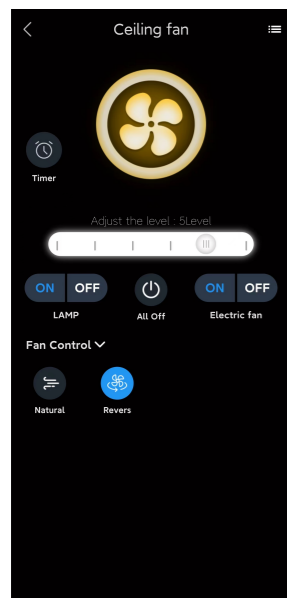

Note: Install the "Tiny Smart" app from Google Play, Apple App Store, or other app stores by scanning the QR code or searching for the app name. Ensure that your phone is connected to the internet and Bluetooth enabled.

Pairing: Add device → Follow the APP operation to turn off the wall switch, and turn it on after 5 seconds. The device will automatically connect to the Ceiling Fan.	
	Slide to adjust the Fan Speed.
	Turn on/off the light.
	Turn on/off the fan.
	Turn off the fan and light.
	1H-8H for timing the fan.
	Natural Wind: Simulate natural wind and automatically adjust the wind speed.
	Fan forward & Fan reverse.

# INSTALLATION MANUAL

## CEILING FAN WITH LIGHT

Model No.: 8037D-52-01

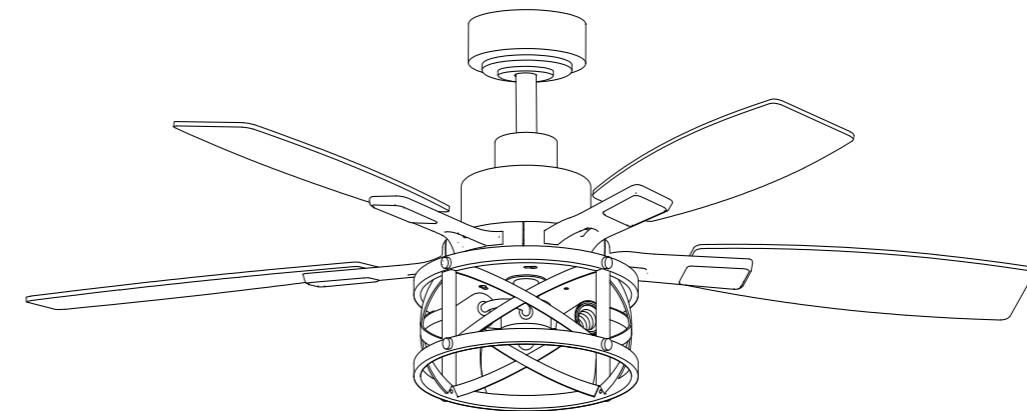

APP Control Applicable

### TOOLS REQUIRED



Ladder

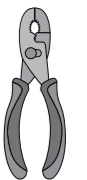

Pliers

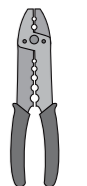

Wire Strippers

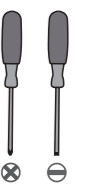

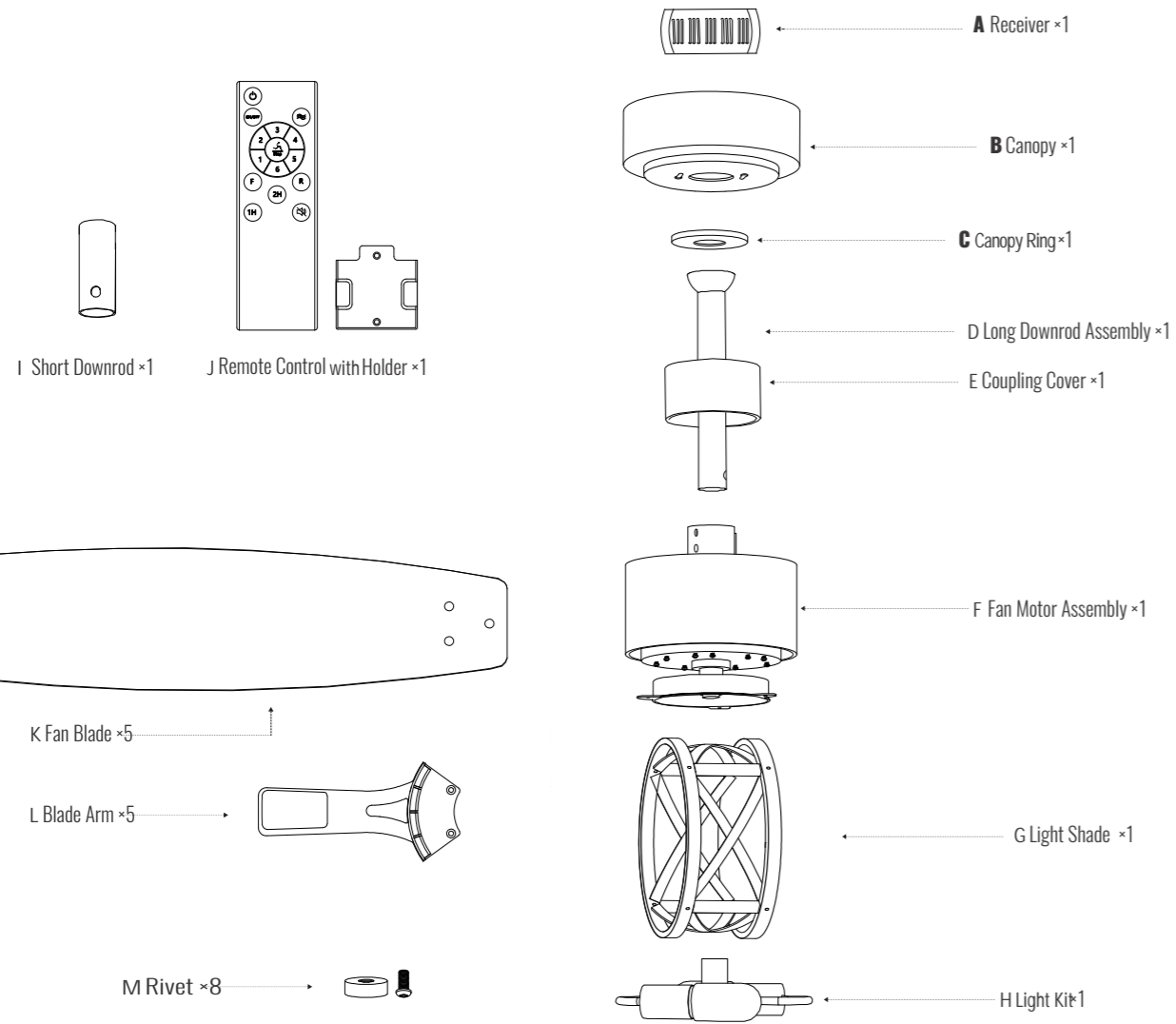

Screwdrivers

# PACKING LIST

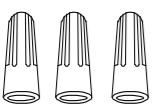

# INSTALLATION KIT

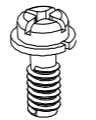
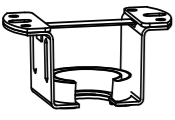
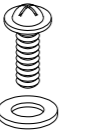
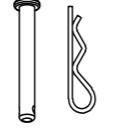
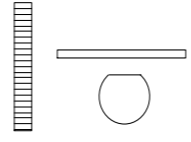
<b>AA</b>  Wire Nut 3×	<b>BB</b>  Fan Blade Screw 15×	<b>CC</b>  Gloves 1×	<b>DD</b>  Fan Blade Arm Screw 10×
<b>EE</b>  Mounting Bracket 1×	<b>FF</b>  Outlet Box Screw With Washer 2×	<b>GG</b>  Clevis Pin & "R" Pin 1×	<b>HH</b>  Nipple Kit 1×

- NOTE:**
- Some extra hardware may be included. The quantity listed above is the number required for installation.
  - Parts "GG" have already been installed with Long Downrod Assembly, parts "DD" have been installed with Fan Motor Assembly. They need to be disassembled before installation.

## 9. Install the Light Kit

- Step 1. Connect the Light Wires from the Light Kit to the fixture wires.
- Step 2. Fix the Light Kit onto the Light Shade (the Nipple passes through the Light Kit).

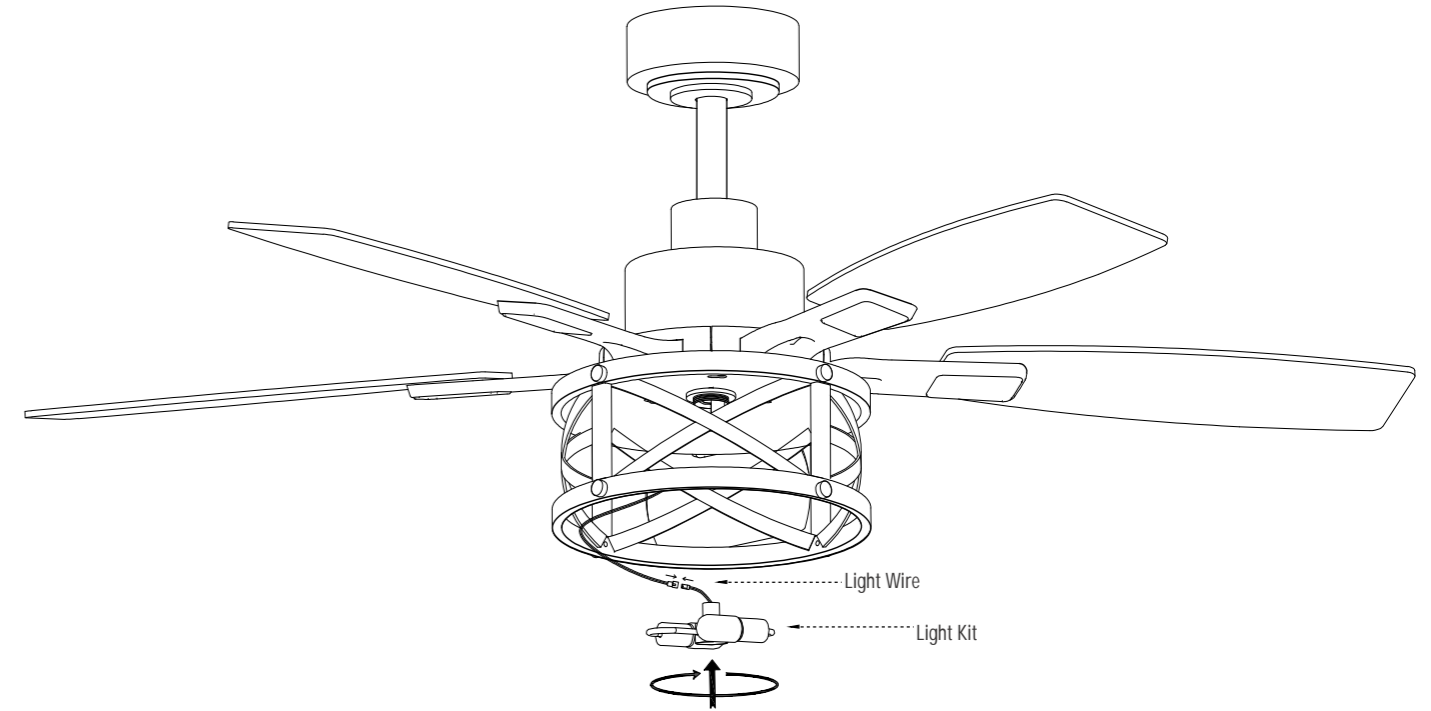

## 10. Install the Nipple Kit and Bulbs

- Step 1. Thread the Nipple through the hole in the Cover and secure it with Nut.
- Step 2. Install 2 E26 Bulbs not exceeding 60W.

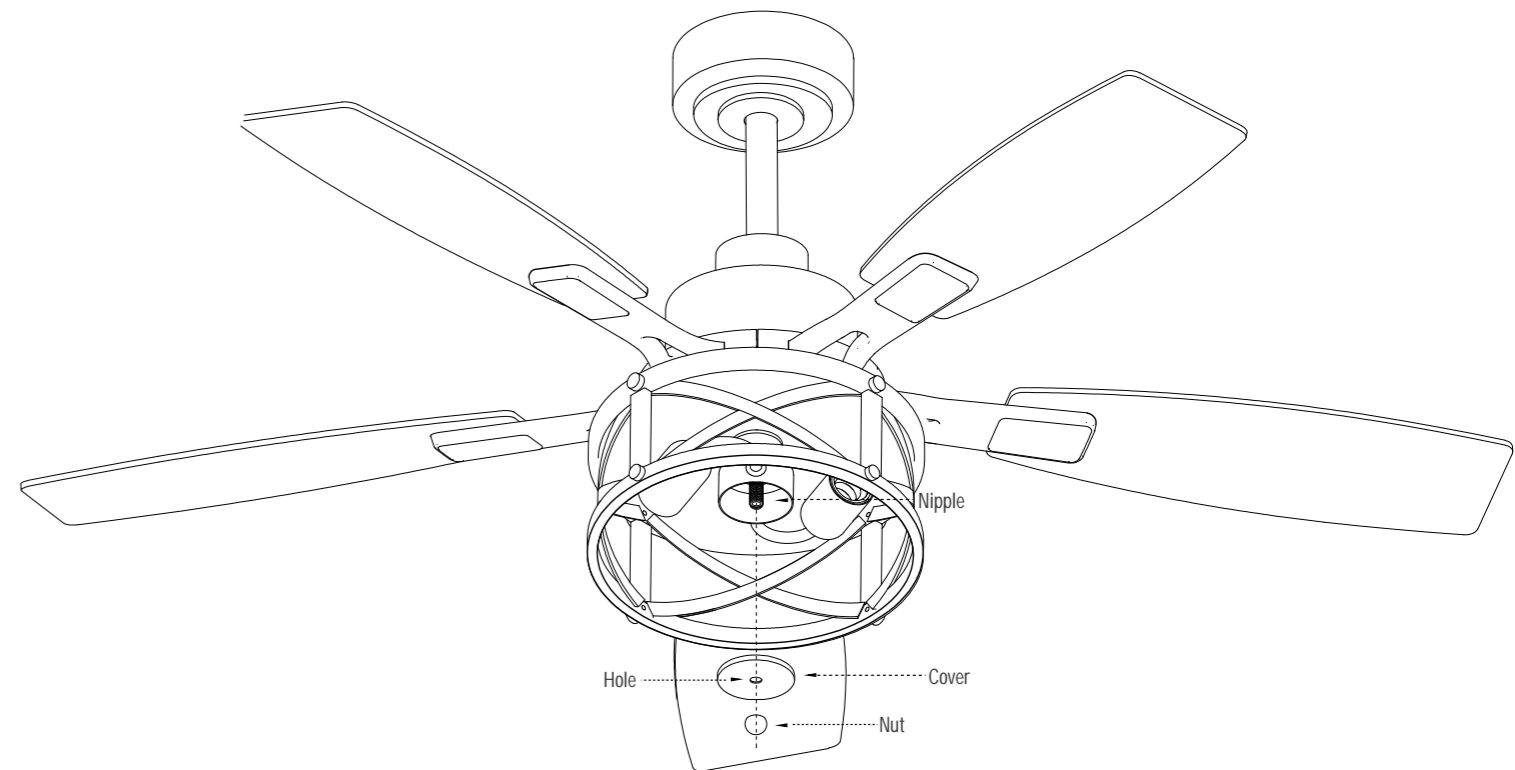

## 7. Install the Light Shade

Step 1. Install Rivets (M) on the Light Shade.

Step 2. Take off one Set Screws from the Fan Motor Assembly.

Step 3. Align the Light Shade with the fixing screw and rotate counterclockwise to temporarily secure it.

Step 4. Attach the Light Shade onto the Fan Motor Assembly with screws taken off.

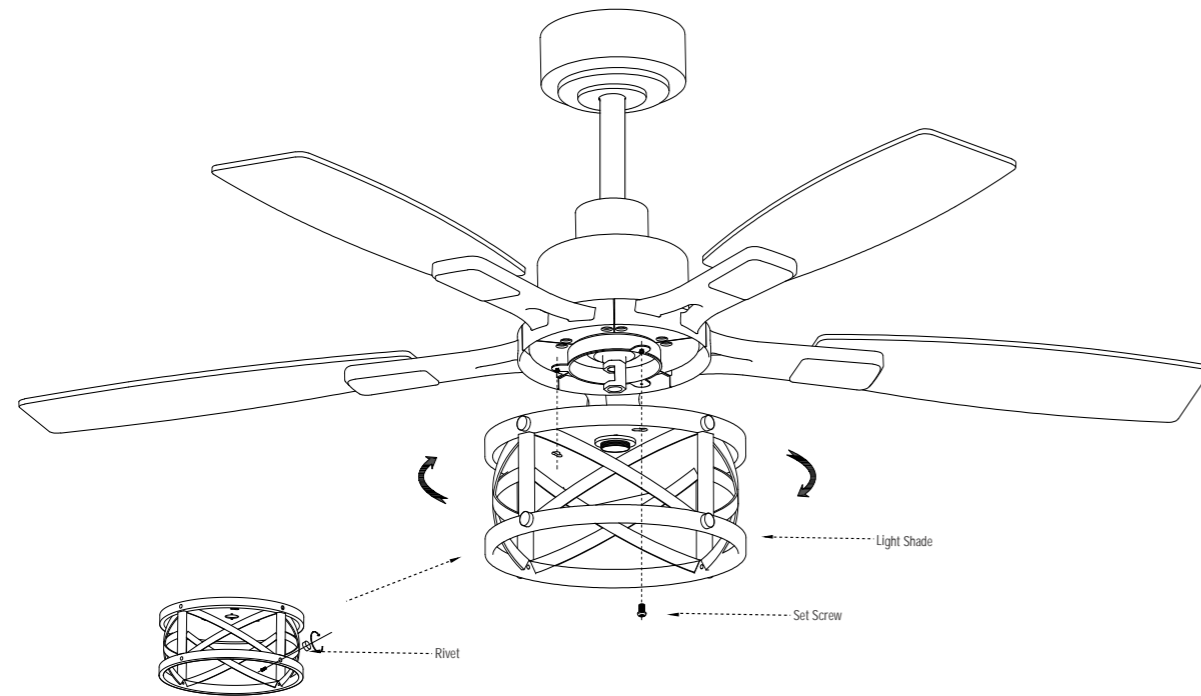

## 8. Attaching the Nipple

Step 1. Attach the Nipple (HH) in the Fan Motor Assembly.

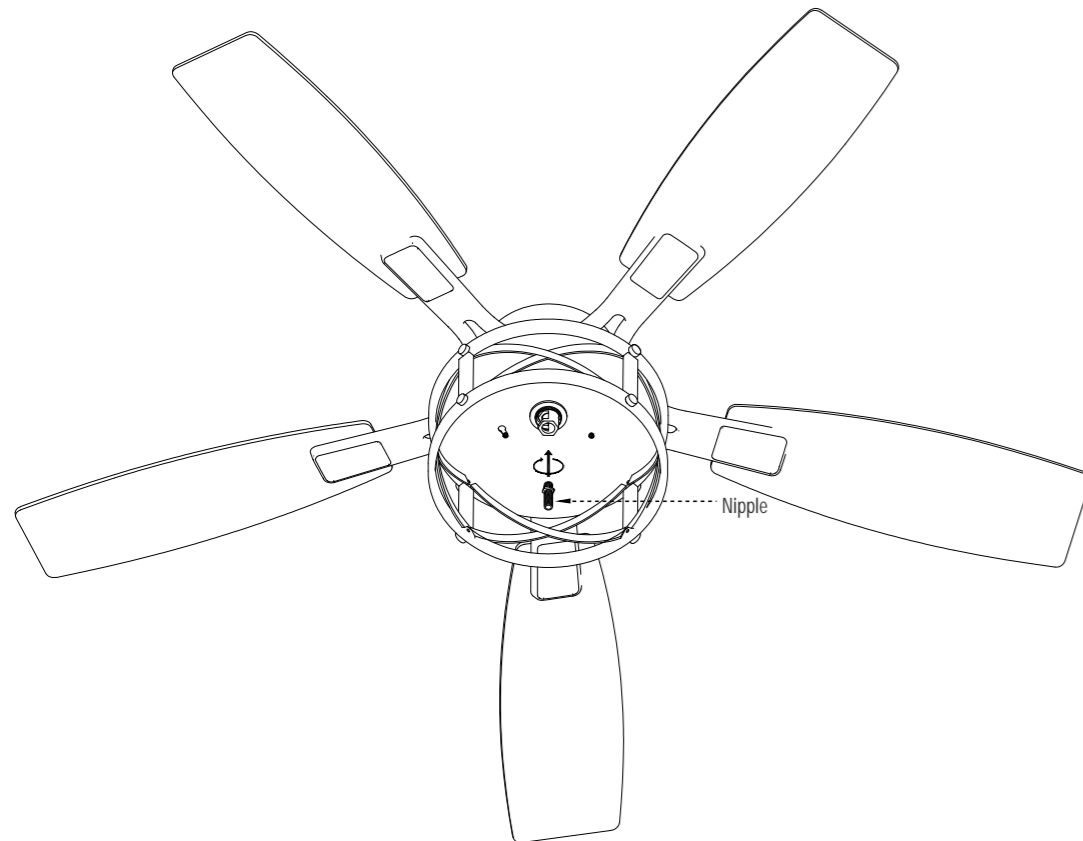

# INSTALLATION

## 1. Installing the Mounting Bracket

Step 1. Take off the screws from outlet box.

Step 2. Secure the mounting bracket (EE) onto the outlet box with screws taken off or Outlet Box Screw With Washer (FF) provided.

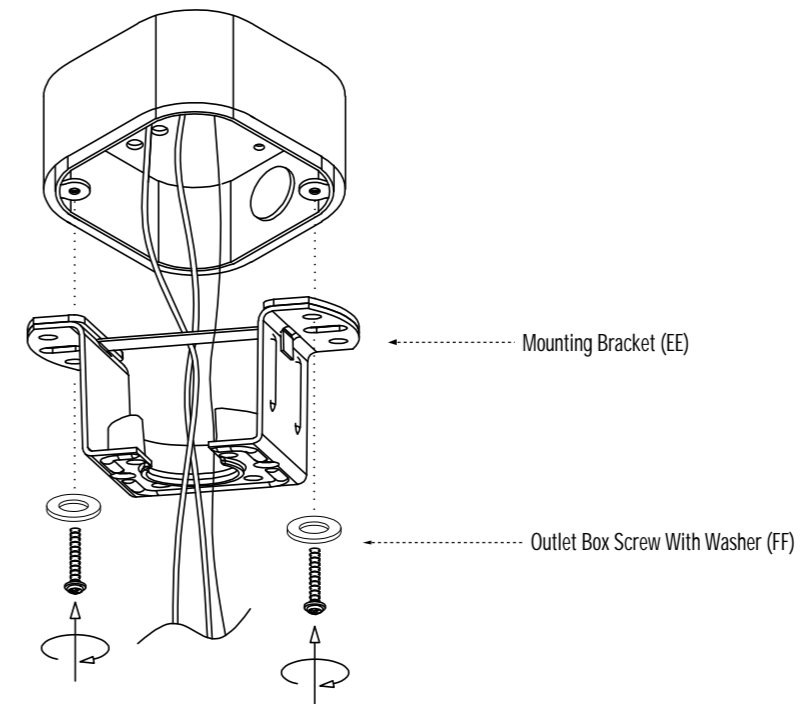

## 2. Assembling the Fan

Step 1. Assemble the Canopy, Canopy Ring and coupling cover, route wires from the fan through the downrod.

Step 2. Loosen the set screw from the yoke but do not take off, align the holes at the bottom of the downrod with those in the yoke.

Step 3. Carefully insert the clevis pin (GG) through the holes in the yoke and downrod (Be careful not to jam the clevis pin against the wires inside the downrod).

Step 4. Insert the "R" pin (GG) into the end of the clevis pin.

Step 5. Tighten the set screw on the yoke to secure the downrod.

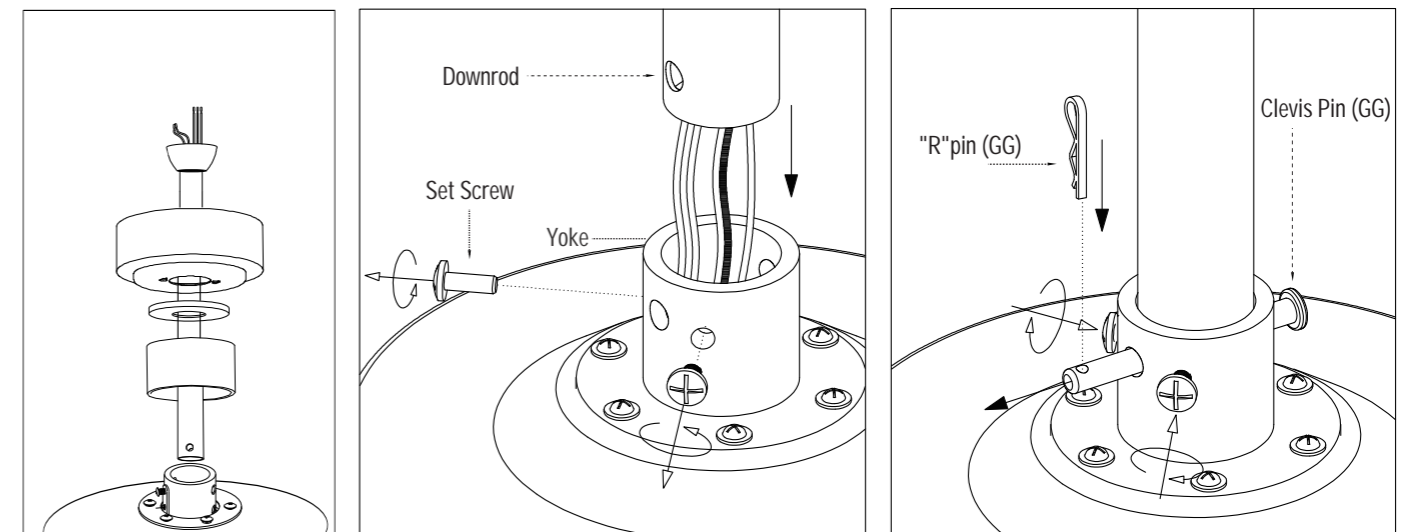

### 3. Hanging the Fan

Step 1. Lift the downrod into the mounting bracket. Rotate the downrod until the seat tab in the mounting bracket is seated in the groove in the downrod ball.

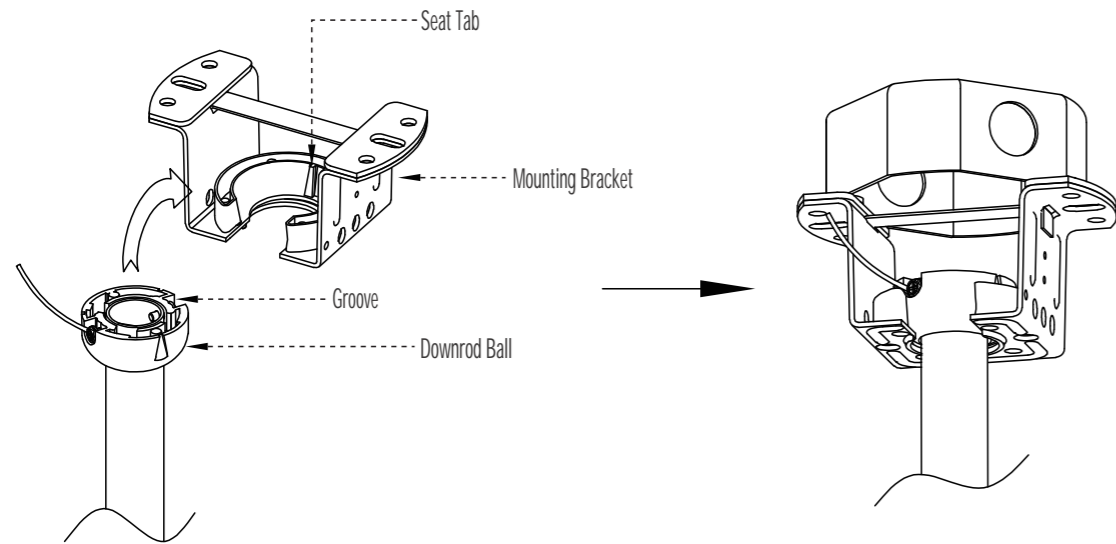

### 4. Wiring

Step 1. Insert the receiver to the mounting bracket

Step 2. Connect the wires from the fixture to the house supply wires with wire nuts (AA), ground wire (green, green/yellow, or bare copper) to ground wire, neutral wire (white or blue) to neutral wire, and hot wire (black or brown) to the hot wire.

Step 3. Wrap the connection with electrical tape.

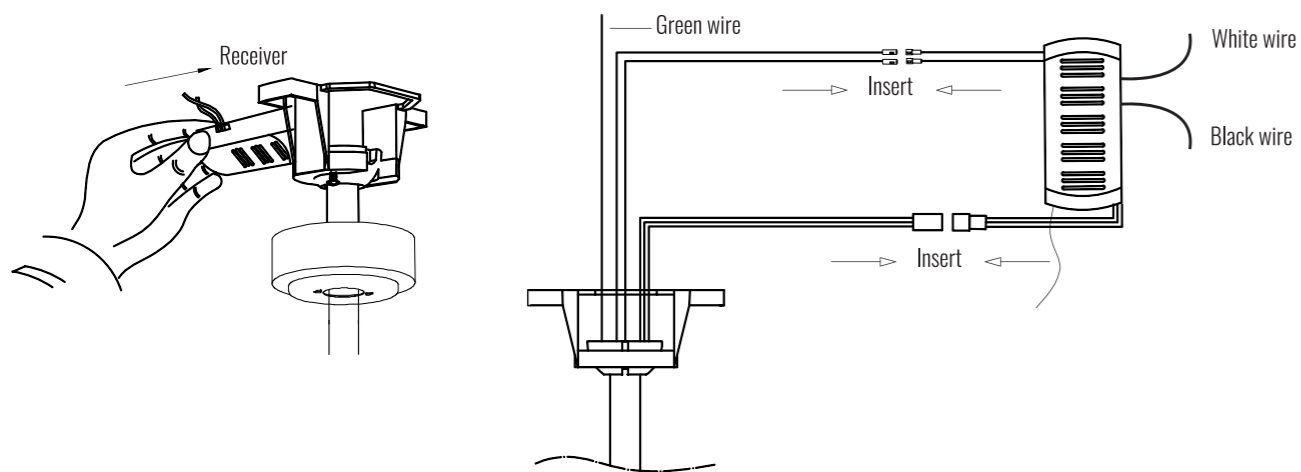

Note:

- ① This fan only needs one set of input wires (black, white, and ground wire). Both of the fan and lights will be controlled by the remote control.
- ② This fan can only be connected to an on/off switch if you have one, not a dimmer switch.

### 5. Attaching the Canopy

Step 1. Slide the canopy up to the ceiling and attach it to the mounting bracket with the set screws provided.

Step 2. Slide the coupling cover downward to cover the yoke and fix the canopy ring to the canopy.

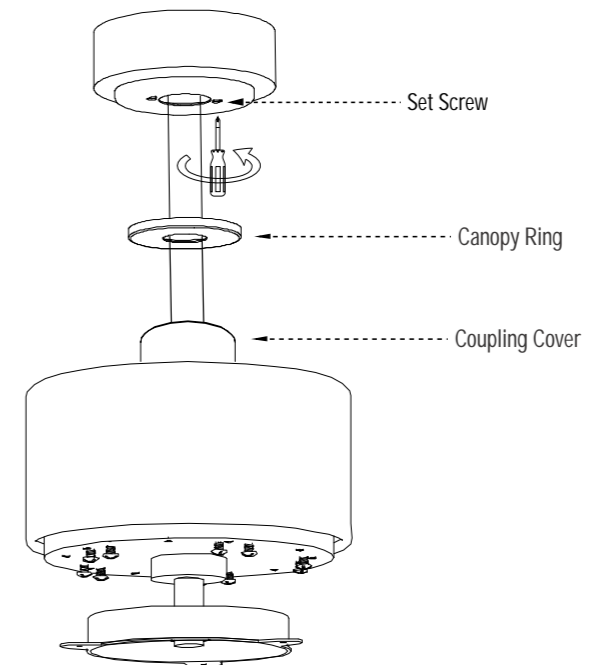

### 6. Installing the Fan Blade and Blade Arm

Step 1. Attach fan blade onto the blade arms with Fan Blade Screws (BB) provided.

Step 2. Take off Fan Blade Arm Screws (DD) from the Fan Motor Assembly.

Step 3. Attach the Fan Blade Arm onto the motor with the Fan Blade Arm Screws taken off.

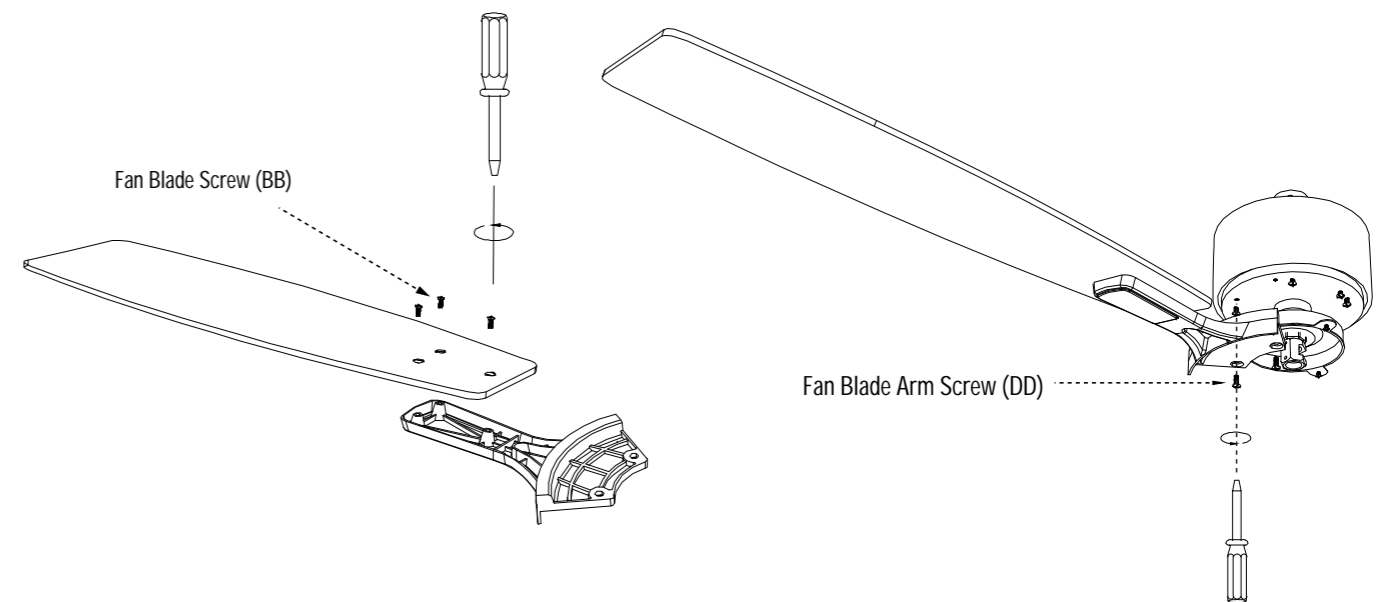

Note:

- ① Make sure to assemble the blades in sequence and fasten the screws with equal force.