





▶ SCAN ME  
Assembly  
Video

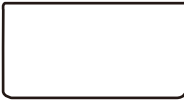

For any missing or damaging parts, hardware, or any other problems, WELCOME to email us at:  
[SERVICE@RILYSON.COM](mailto:SERVICE@RILYSON.COM)

**Or 1-888-733-8169 Toll free**  
**Monday-Friday 9AM - 5PM EST**

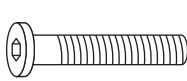
\* Don't fully tighten all the bolts till the very end!

	PART LIST	DESCRIPTON	QTY
A		Leg Panel	2
B		SIDE Panel	2
C		TOP Panel	1
D		WASHER -- M6	12
E		BOLT -- M6 x 35mm	12
F		HEX WRENCH	1
G		Seat Cushion	1

**PRE-ASSEMBLY PREPARATION:**

--- Please read through the instructions before beginning assembly.

--- Clear out the space for assembly and lay out all of the parts based on the Parts List, extra room will allow you to easily determine if all the pieces are present.

--- Keep small parts and pieces away from children until fully assembled.

Step 1: Attach 2pcs leg panels (A) to top panel (C) with 4pcs bolts (E) and 4pcs washers (D).

\* Do not fully tighten bolts until the entire frame is assembled.

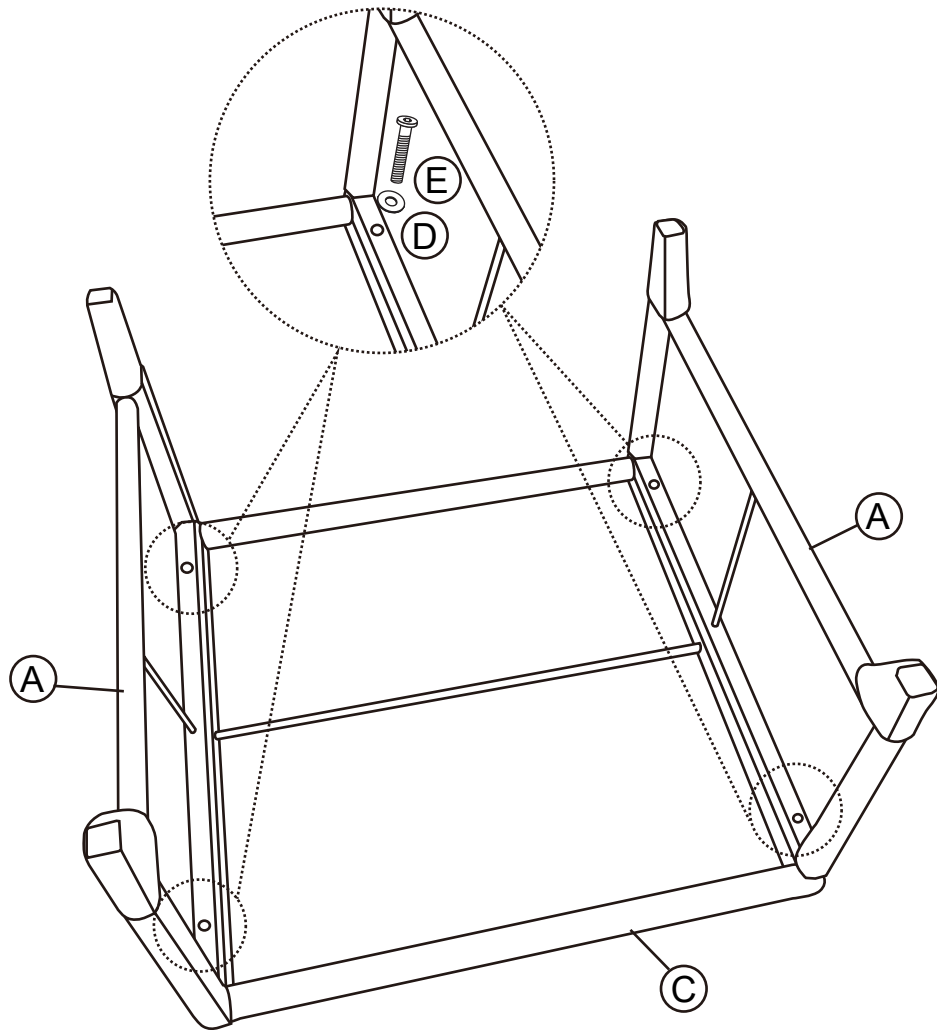

Step 2: Attached 2pcs side panels (B) to leg panels (A) with 8pcs bolts (E) and 8pcs washers (D).

Turn over the assembled ottoman. Verify the alignment and adjust, now fully tighten all the bolts using Hex Wrench (F). Put cushion on and do up the bottoms.

