

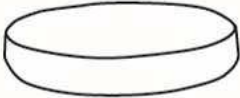

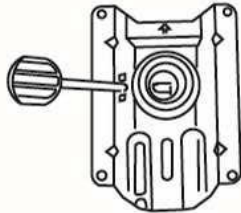



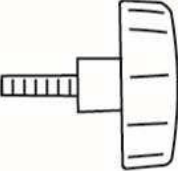

**IMPORTANT NOTICE:
HARDWARE PACKAGE IS ATTACHED
ON THE BOTTOM OF SEAT CUSHION.**

(1)x1  Seat Cushion	(2)x1  TU001-305/Mechanism	(3)x1  Back Cushion W/ Back Support & Bellow
(4)x1  TU305-Knob/Knob	(5)x1  TU026-240/5 / Gas Lift	(6)x1  TU005-240/5 / Base
(7)x1  TU009	(8)x1  TU009-EXT	(9)x5  TU015 / Casters
(A)x4  M8X22 MECHANISM SCREW		



Insert and loosely tighten all screws. When assembly is completed, fully tighten all screws before using. This chair is only intended for sitting. Any other use will void the warranty.

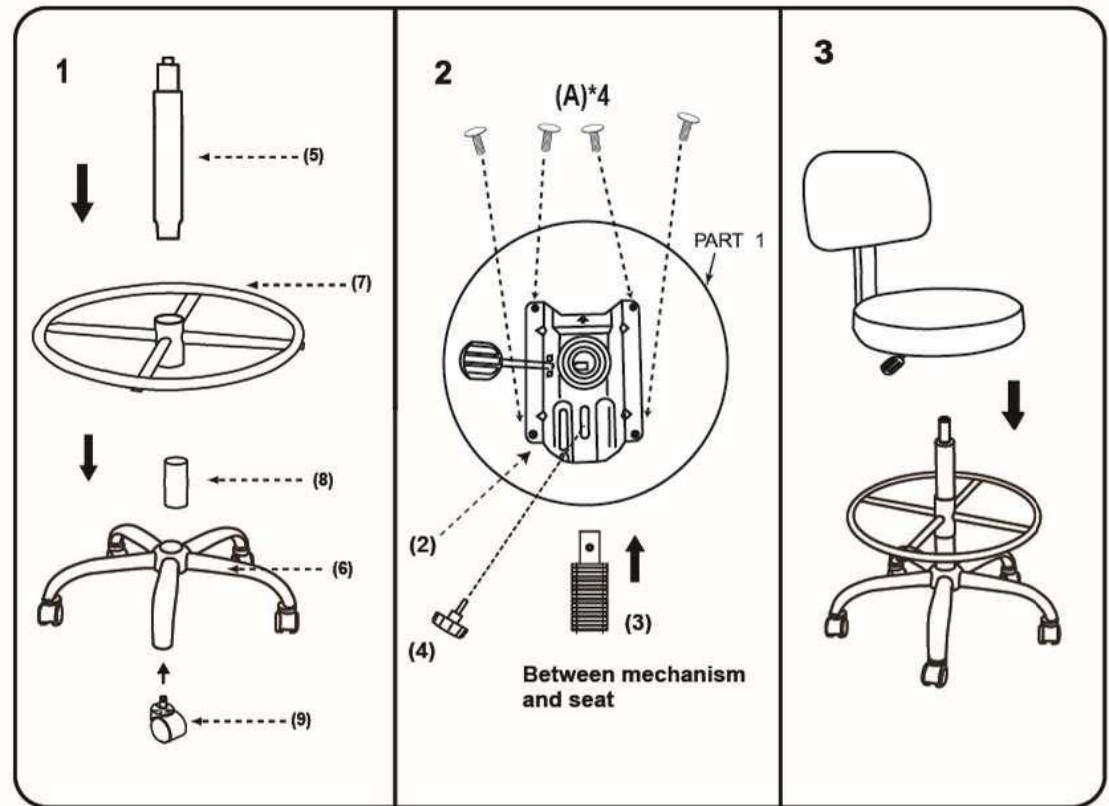