











## Hardware List

<b>A</b>  20PCS	<b>B</b>  22PCS (M4*12)	<b>C</b>  2PCS	<b>D</b>  x1 2PCS	<b>E</b>  1PC
<b>F</b>  1PC	<b>G</b>  G <sub>1</sub> G <sub>2</sub> G <sub>3</sub> 2PCS	<b>H</b>  2PCS (M6*10)	<b>I</b>  4PCS	<b>J</b>  1PC
<b>K</b>  4PCS	 2PCS	 1PC		

## Panel List

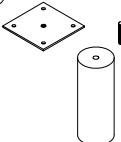
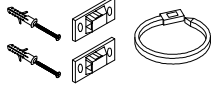
<b>1</b>  1PC	<b>2</b>  1PC	<b>3</b>  1PC	<b>4</b>  1PC	<b>5</b>  1PC
<b>6</b>  1PC	<b>7</b>  1PC	<b>8</b>  1PC	<b>9</b>  1PC	<b>10</b>  1PC
<b>11</b>  1PC	<b>12</b>  1PC	<b>13</b>  1PC	<b>14</b>  1PC	

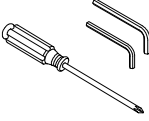
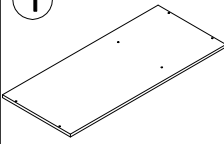
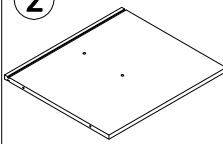
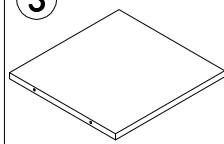
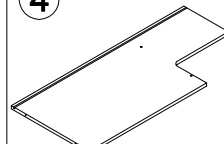
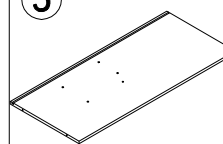
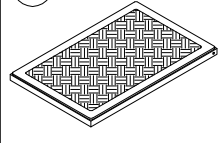
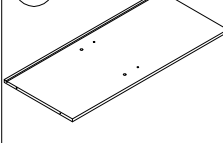
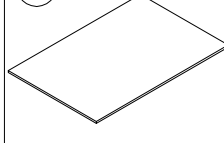
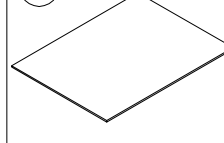
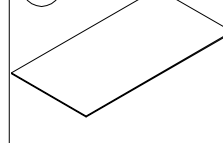
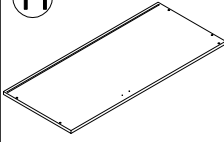
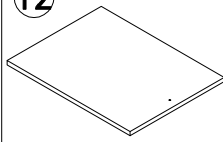
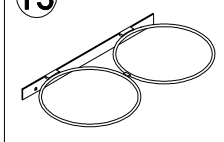
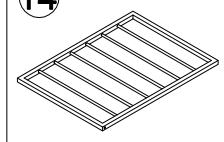
step 1

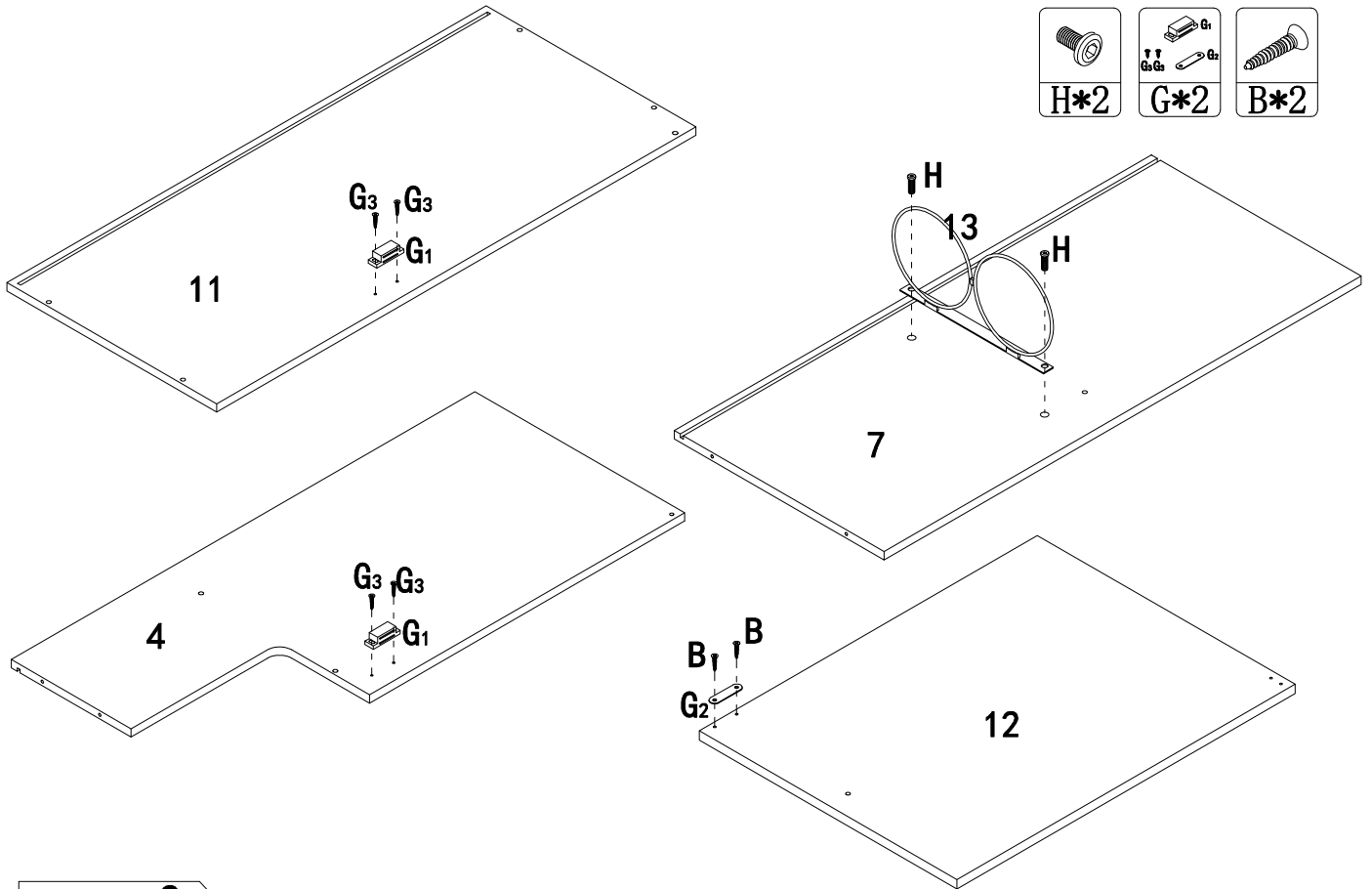

step 2

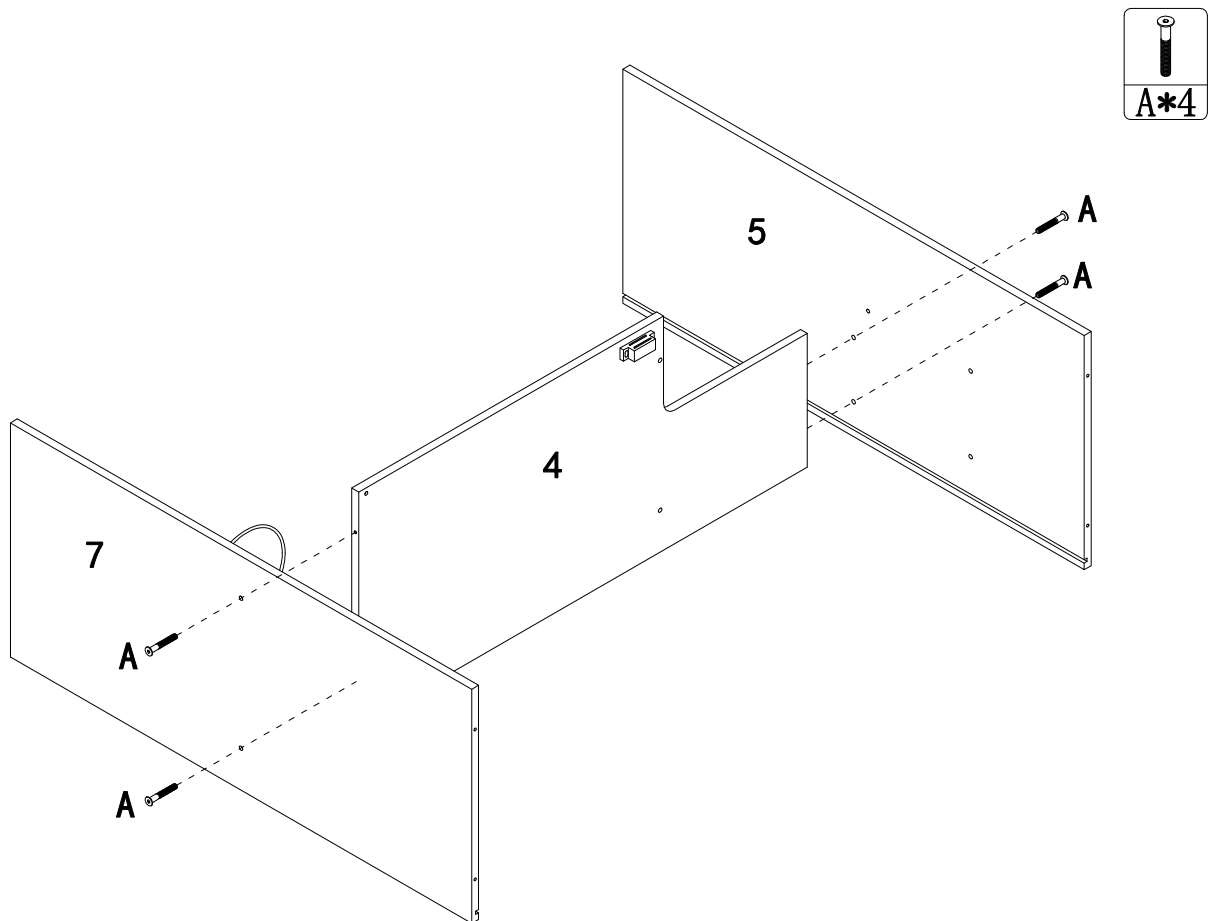

step 3

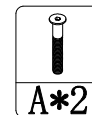
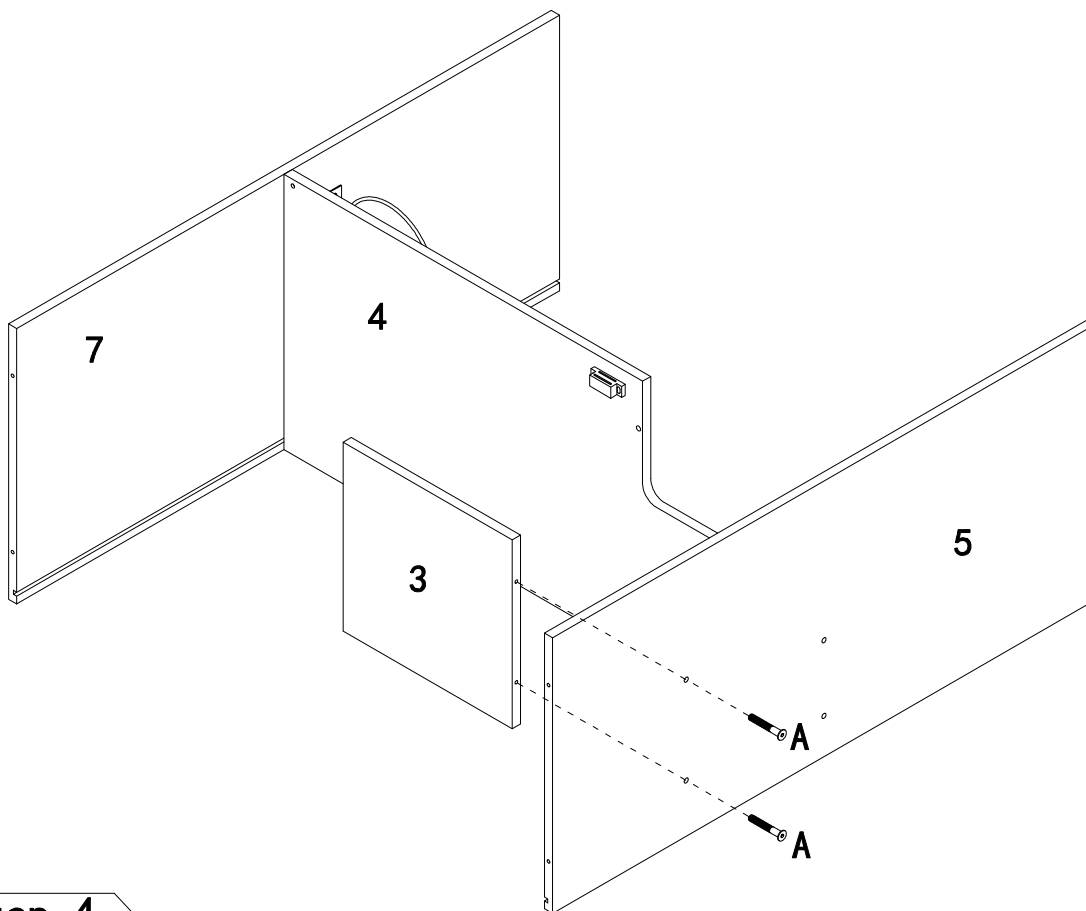

step 4

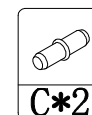
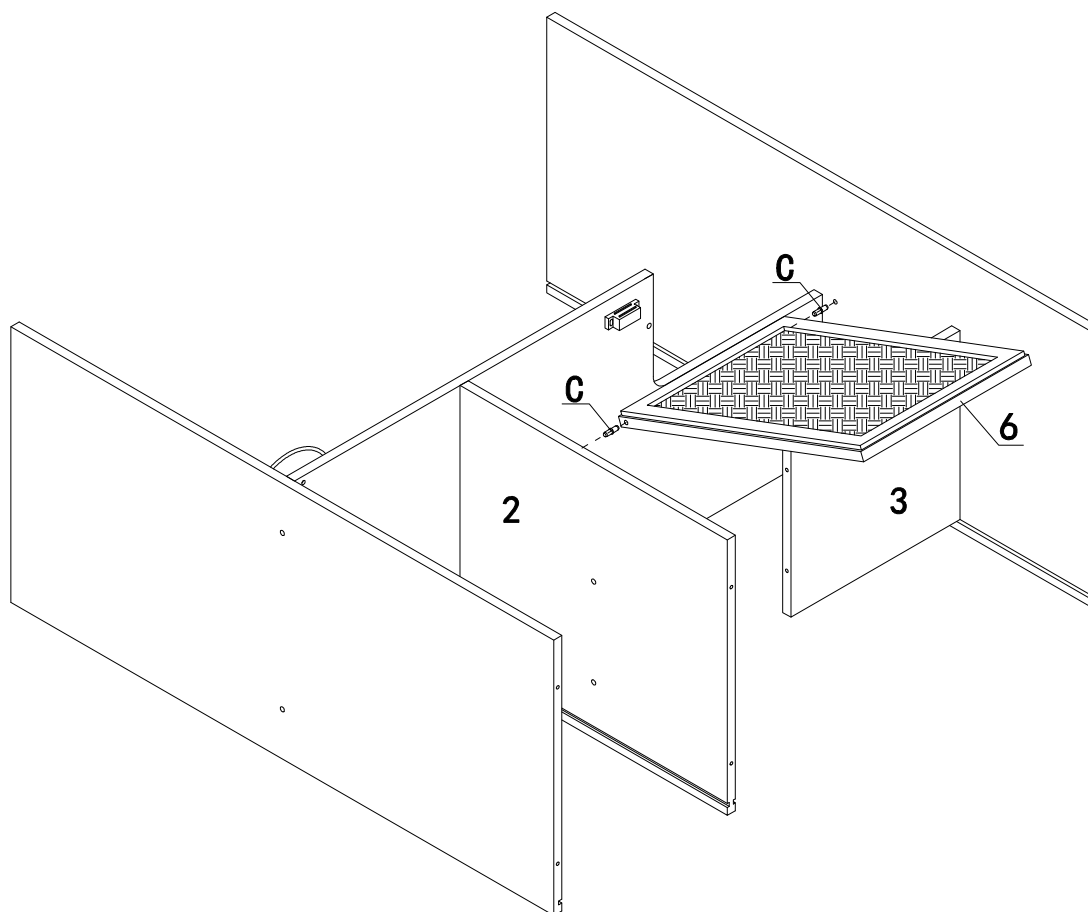



step 7

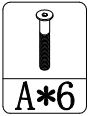
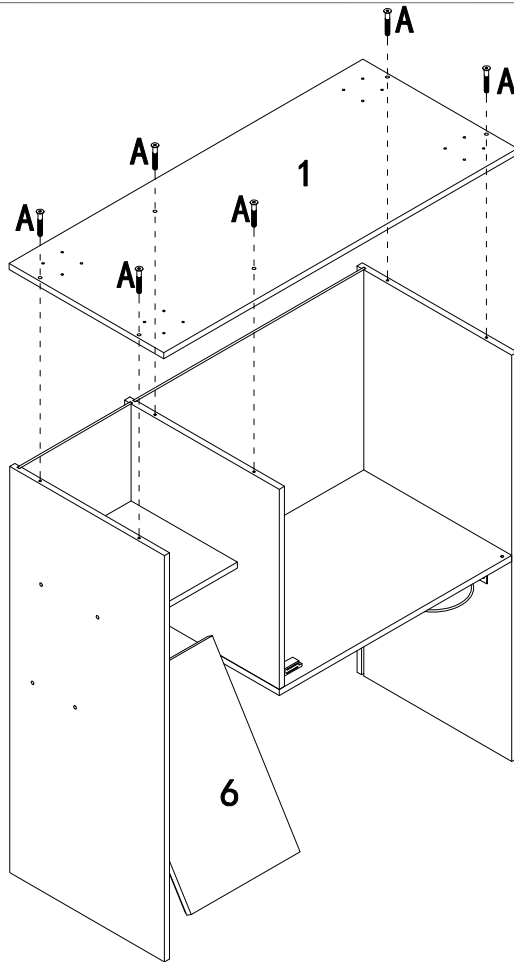

step 8

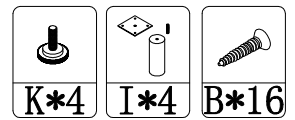
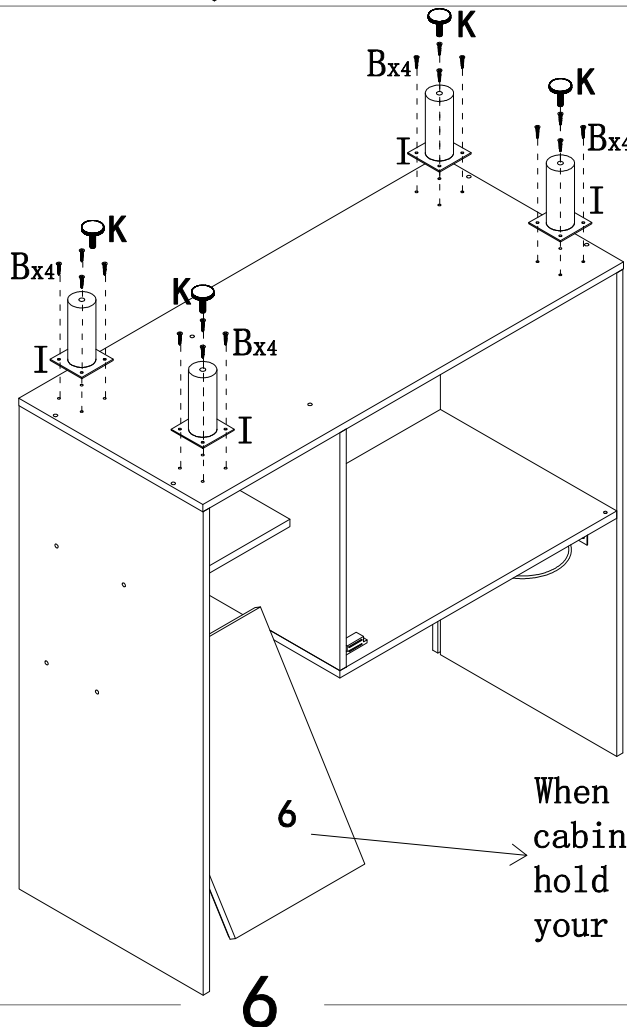
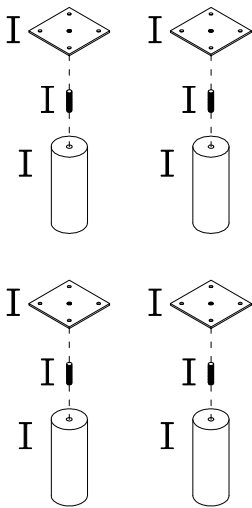

When flipping the cabinet, make sure to hold onto board 6 with your hand

**step 9**

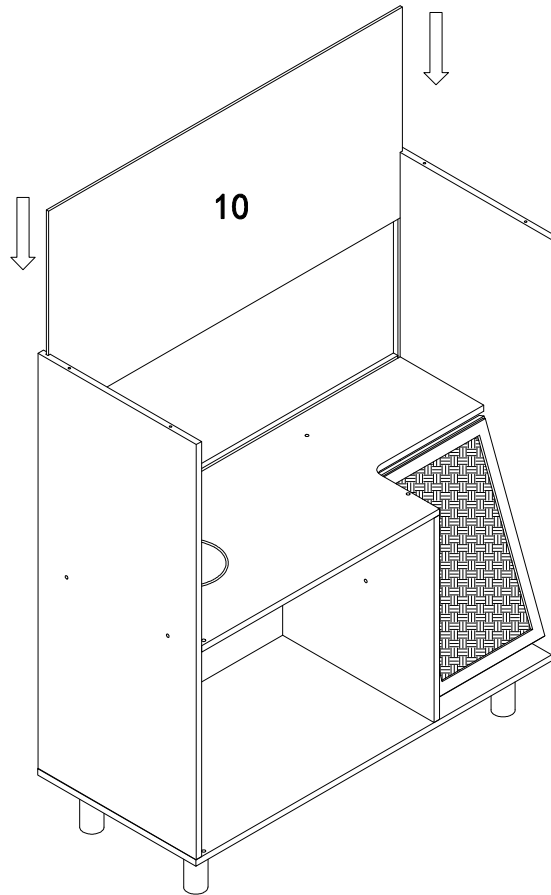

**step 10**

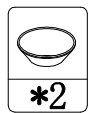
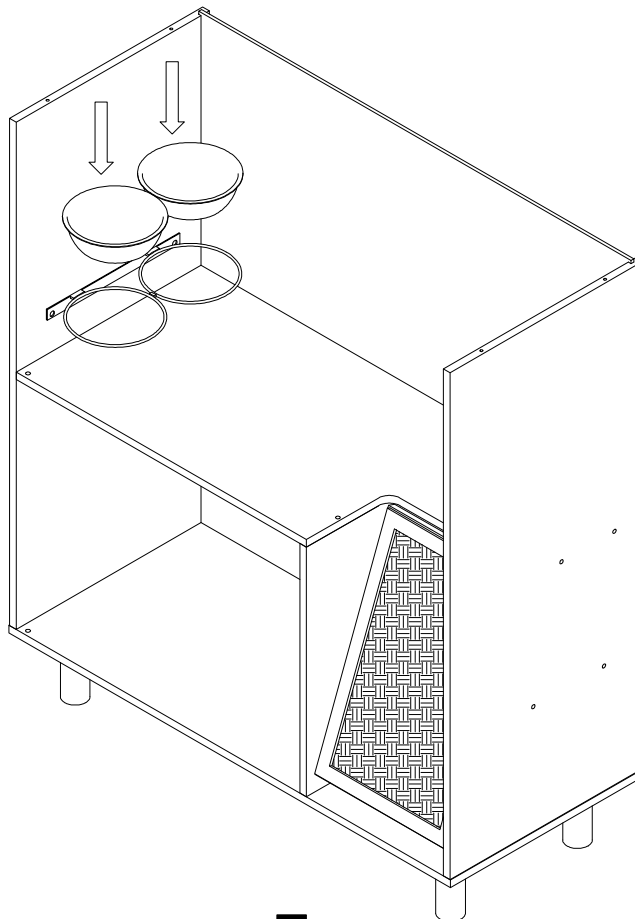

step 11

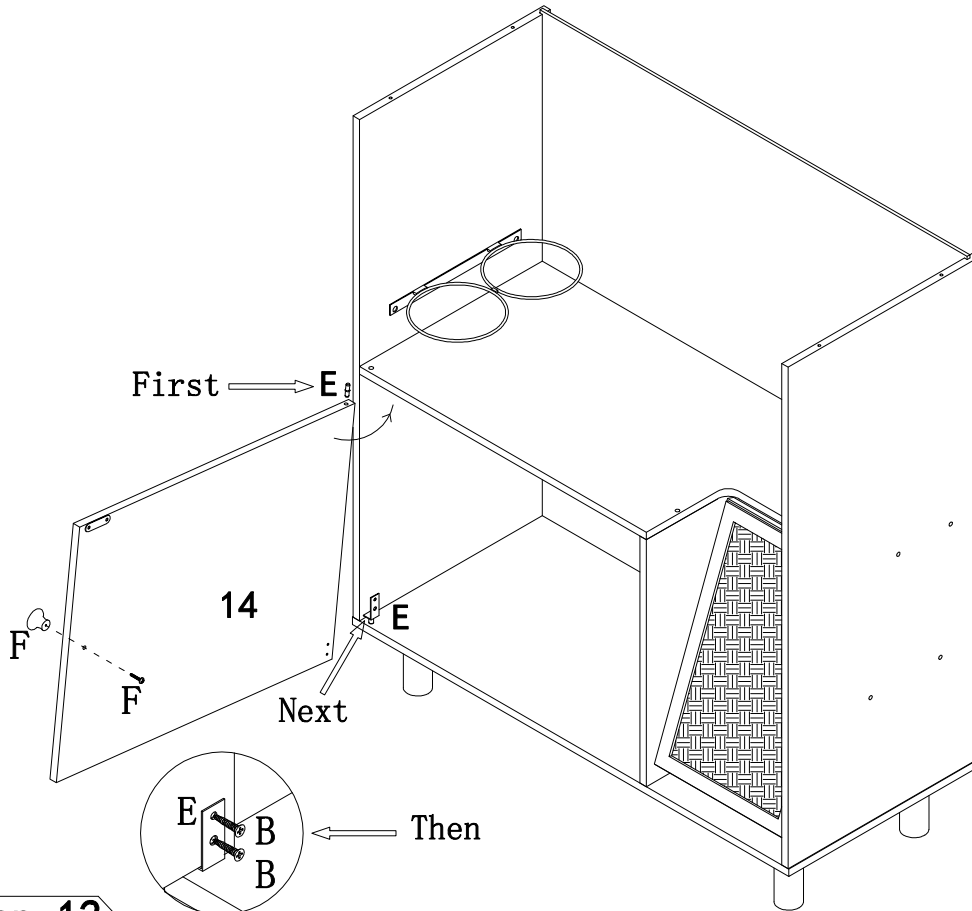
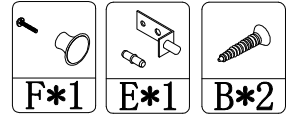

step 12

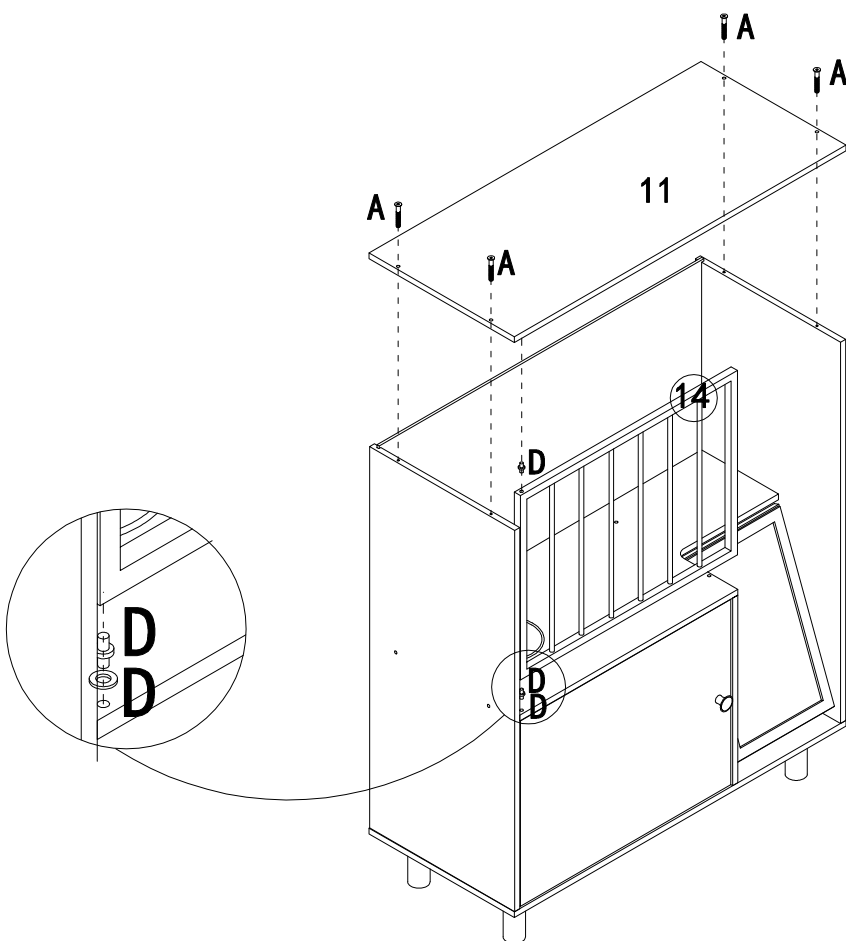
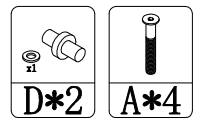

step 13

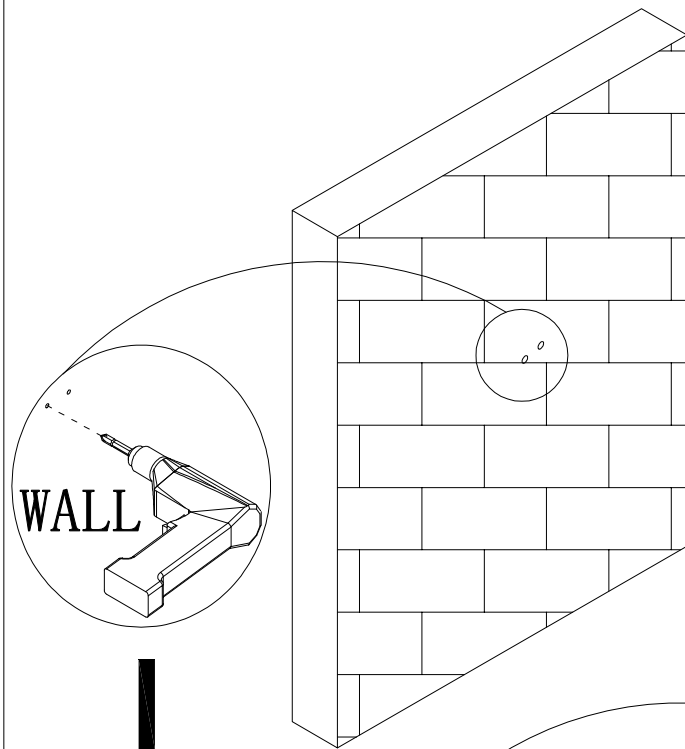
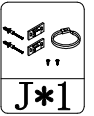

Installation instructions for  
furniture anti-tip device

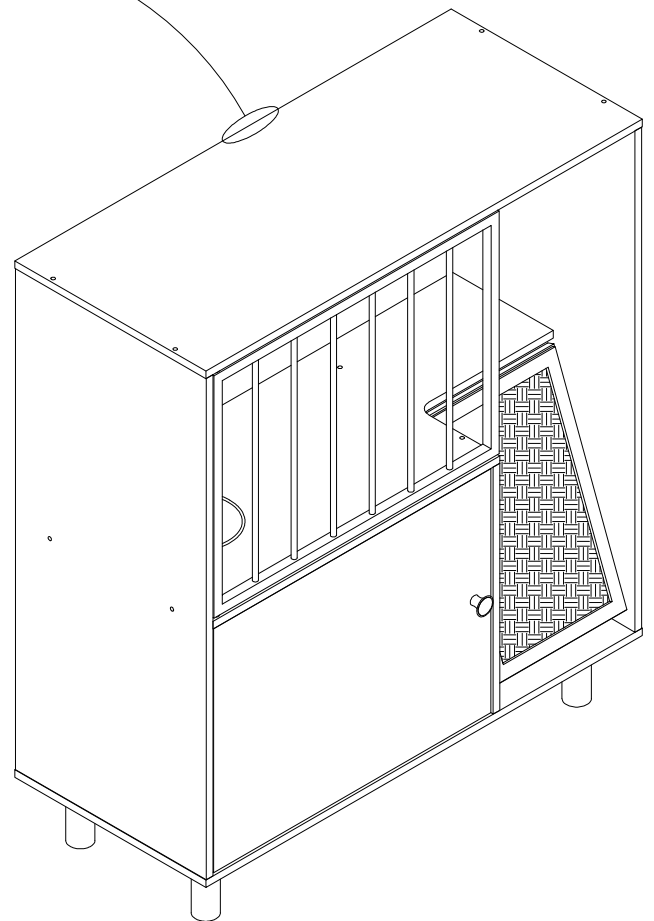
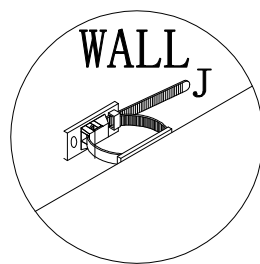
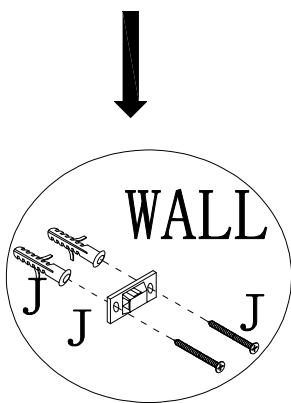
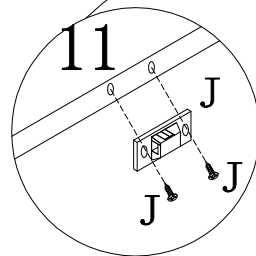
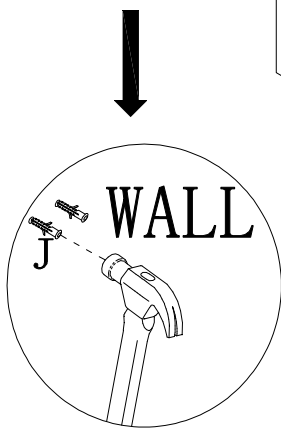

# Warning: Tip-Over Hazard!

1. Dangerous tipping may occur, potentially causing serious injuries.
2. Prevent tip-over: Use tip-over restraint device provided. Secure to wall where possible.

3. Instructions: Follow the detailed installation instructions.

4. In Emergency: Here's what you should do in the event that the furniture tips over.

Stay Calm: Try to keep calm and assess the situation.

Seek Help: If the situation is serious, immediately dial the emergency services number for medical assistance.

5. If you have any questions, please contact us immediately.

