

Assembly Instruction









Accent Chair

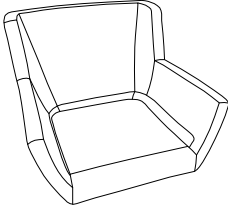

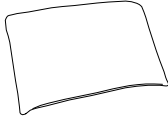
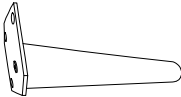
Legs & hardware are stored in the bottom of the seat, please take them out for assembly.

Note: Do not use power tools for assembly. Power tools increase the risk of over tightening which lead to splitting or cracking the wood. Do not tighten bolts until completely assembled.

Component list

No	Drawing	Qty	Description
A		1	Chair
B		1	Seat cushion
C		1	Back cushion
D		2	Front Wooden Leg 8.15"*3.23"*3.23"
E		2	Rear Wooden Leg 7.2"*3.23"*3.23"
F		12	Bolts 5/16"*32mm
G		12	Flat Washers Ø19*Ø8*1.5mm
H		12	Lock Washers 5/16"*13*1.5mm
I		1	Allen Wrench M4*70*35mm

Step #1

LEGS AND HARDWARE ARE STORED IN THE BOTTOM OF THE SEAT.

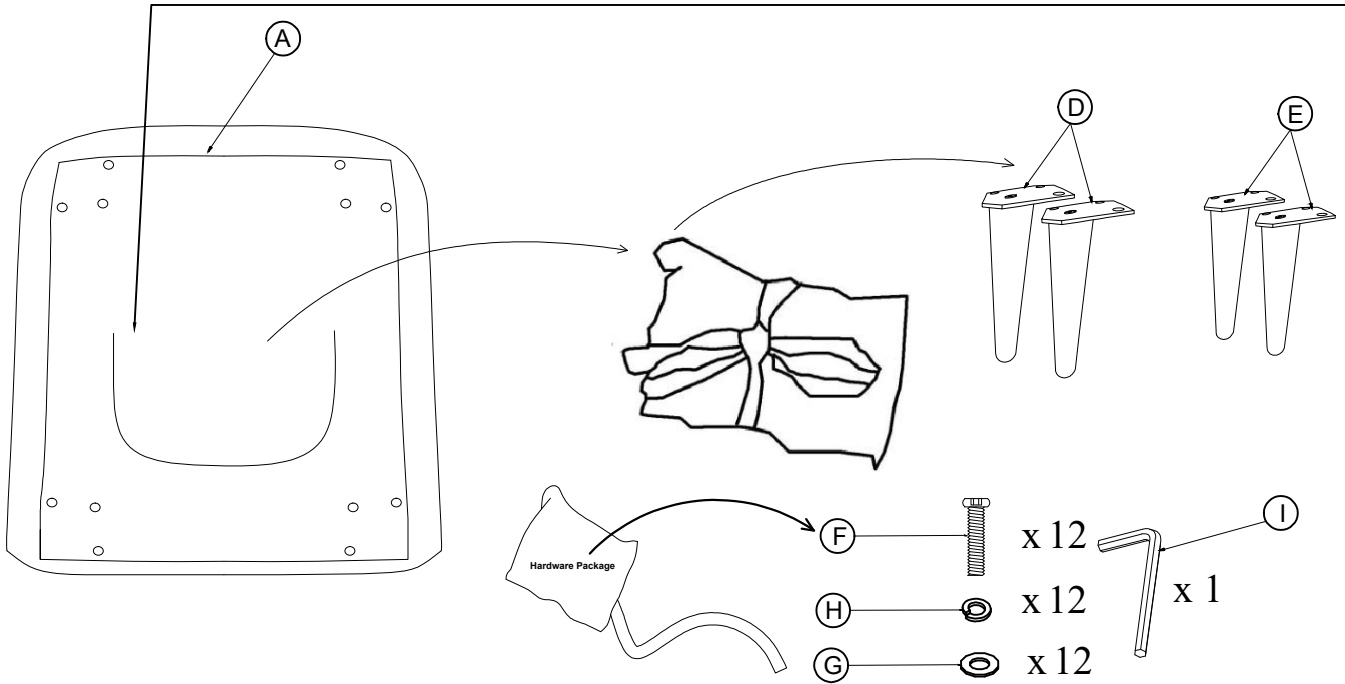

Step #2

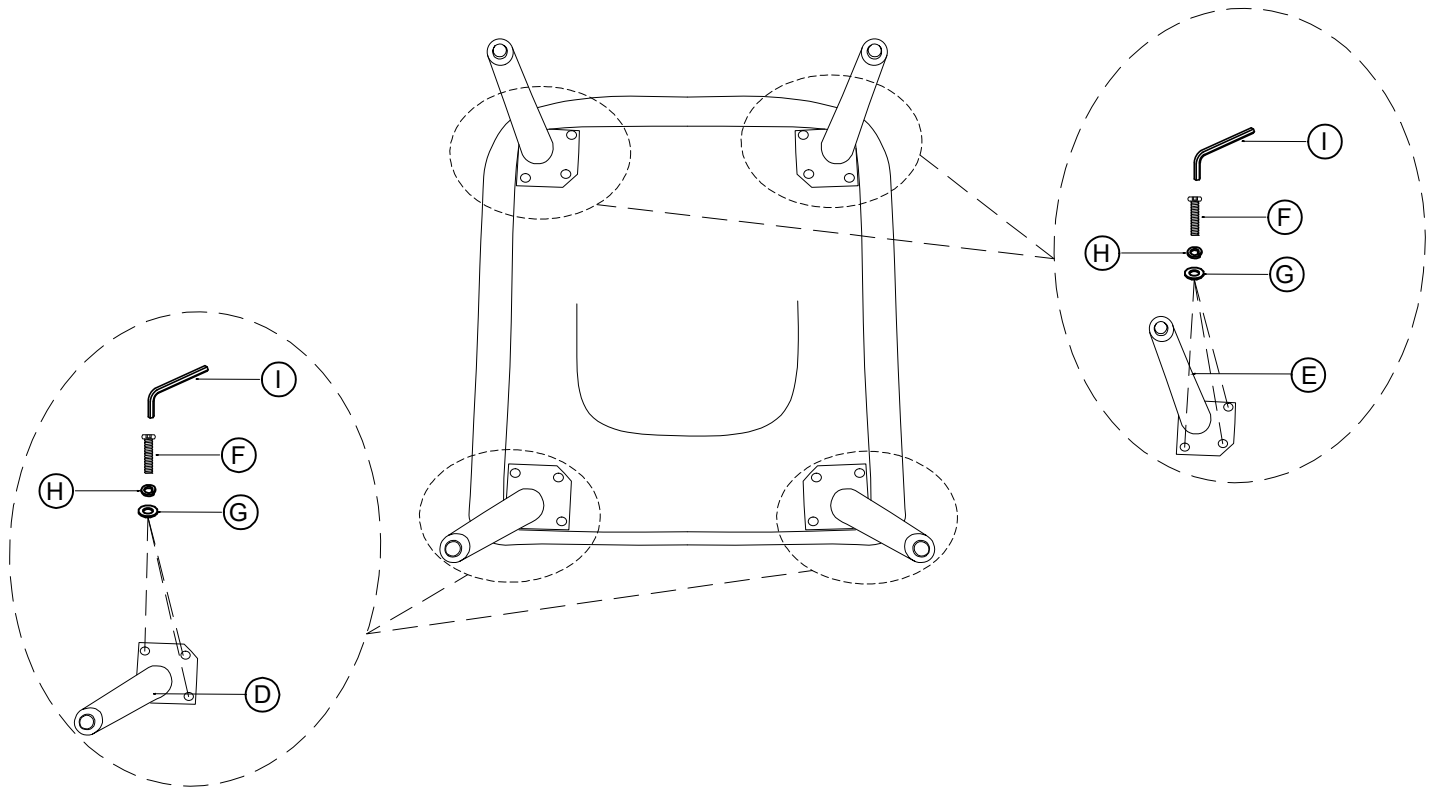

Step #3

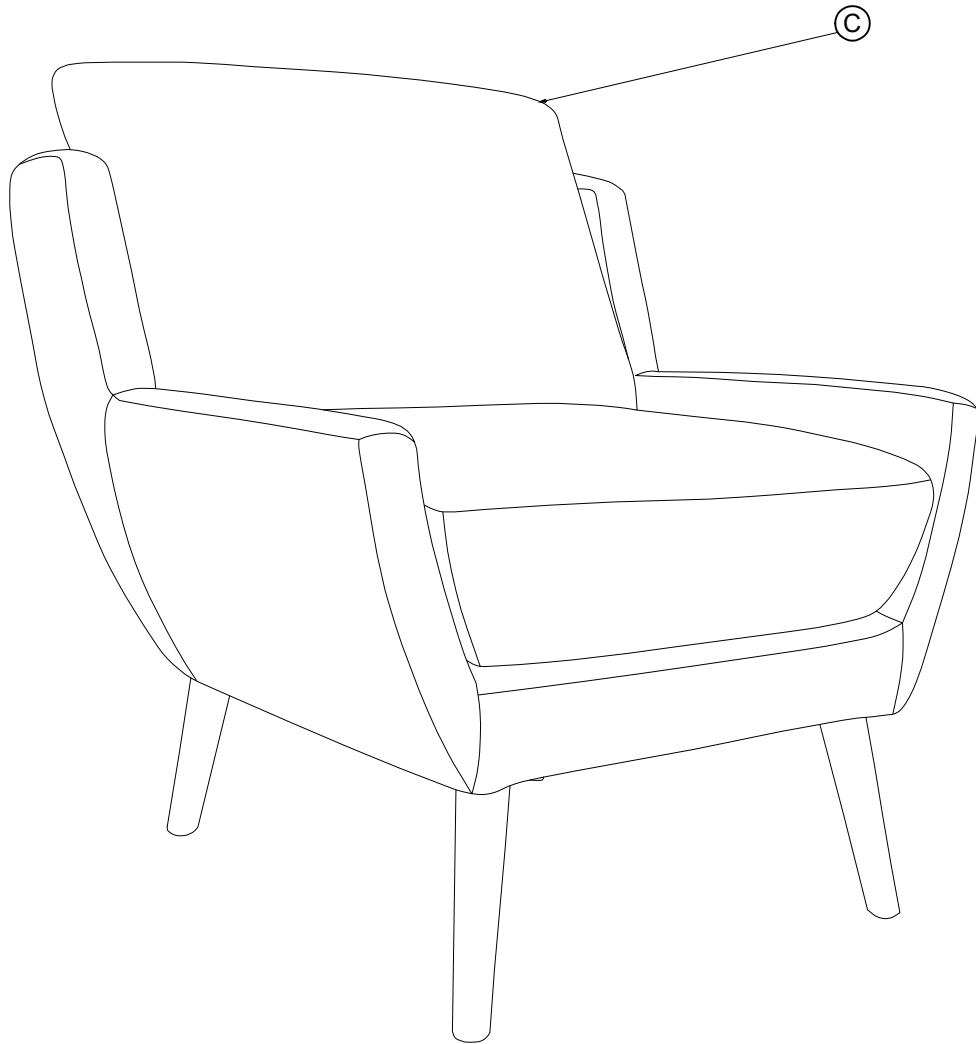

Care Instruction for Chenille Furniture:

In order to maintain the original appearance of your chenille Furniture, please follow below simple care procedures:

- Avoid exposing furniture directly to sunlight or heating and air conditioning outlets. Sunlight and or exposure to heating and air conditioning outlets will fade/damage chenille.
- Vacuum or wipe with a soft cloth to remove dust.
- Hardware may loosen over time. Periodically check to make sure all connection are tight, Re-tighten if necessary



For items use on wooden floor, hard surfaces or carpets, it is recommended to Install protective pads under all legs and supports to avoid/prevent from damages/scratches and discoloration.