

Installation Manual

Jim's Maison

Good Choice!



BathroomVanity Bathtub Mirror MedicineCabinet ShowerDoor ShowerSystem Faucet Basin Toilet

Service	WEBSITE http://jimsidea.com	E-mail service@jimsidea.com	Phone +1 213-254-4311
----------------	--	--	--------------------------

Tools List

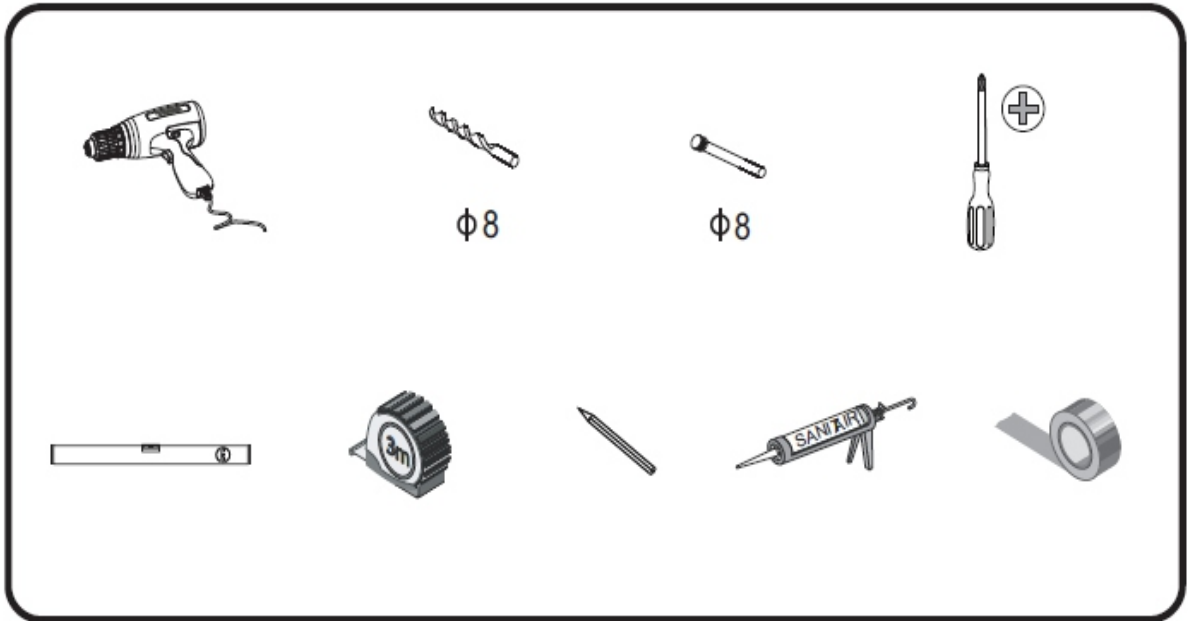

Parts List

Cabinet

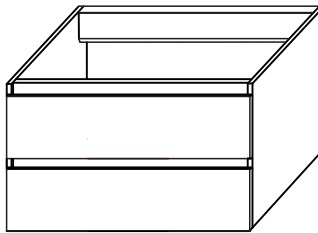

Basin

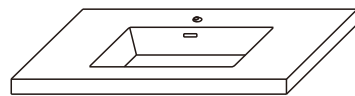

Fixed Accessories

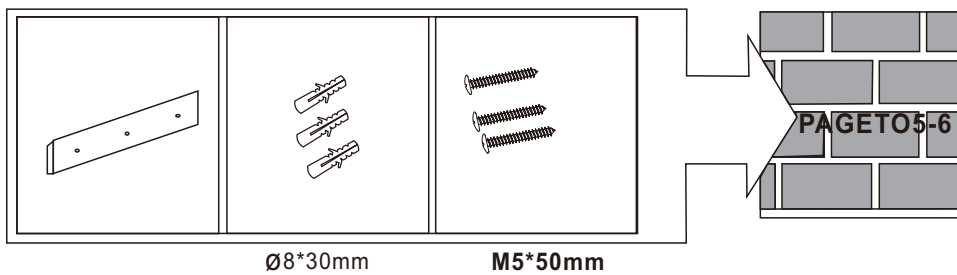

1

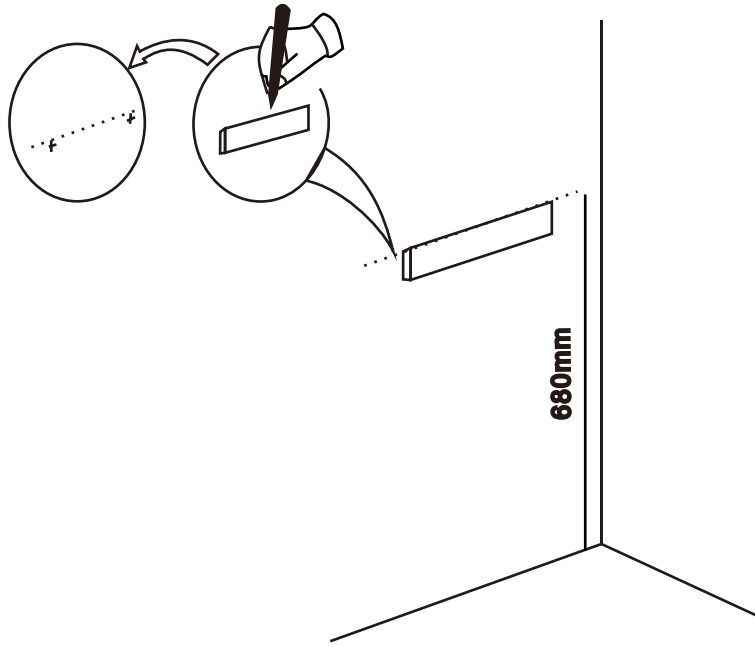

2

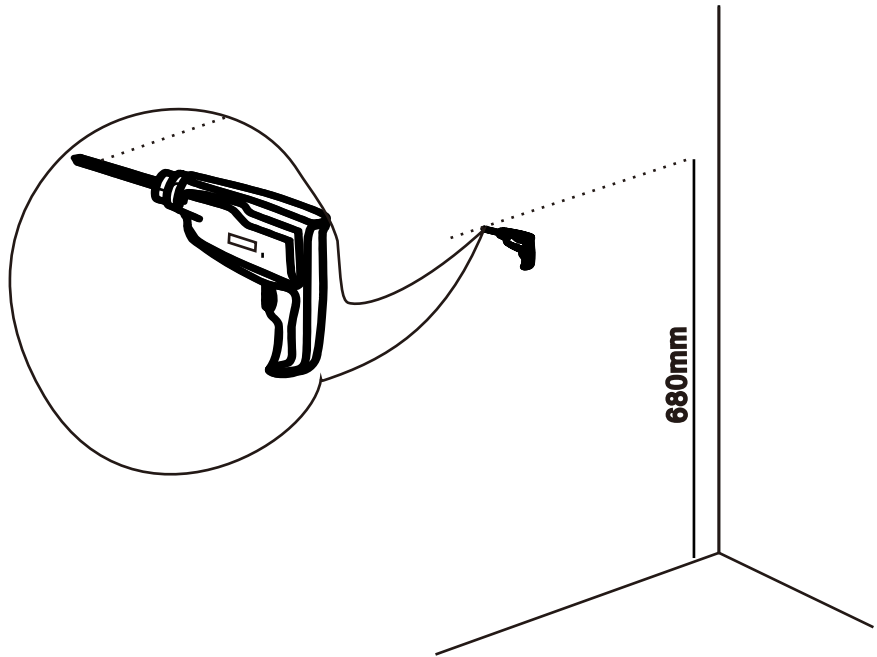

3

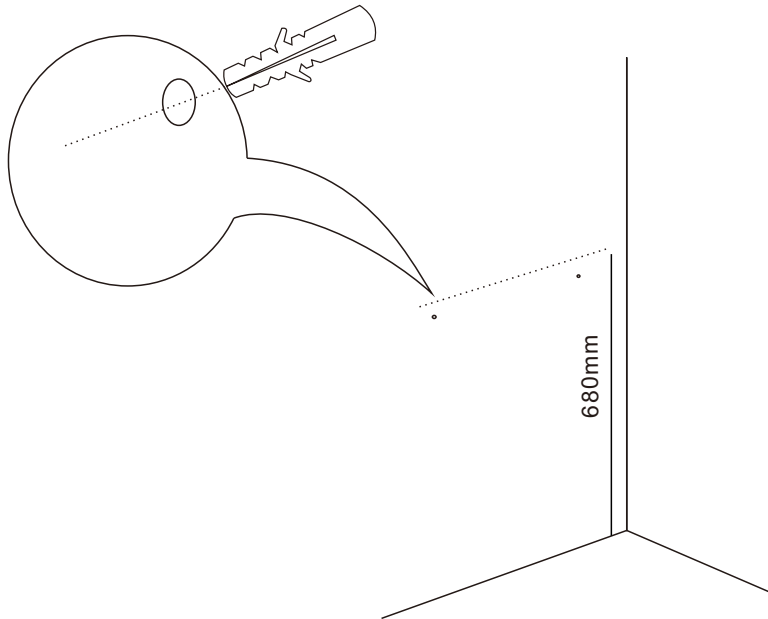

4

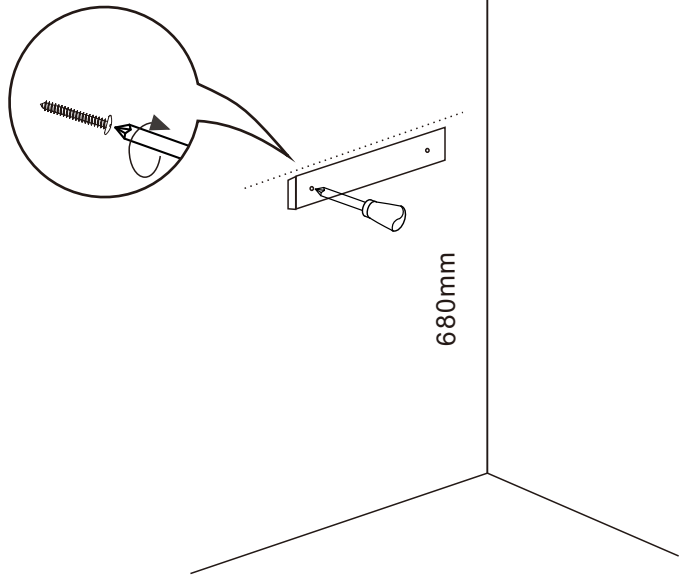

5

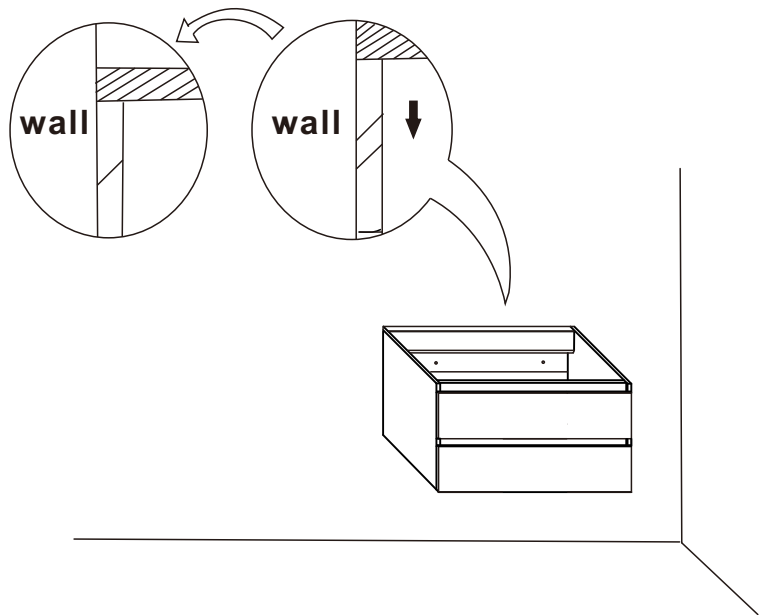

6

