

Bedside Cupboard Installation Manual

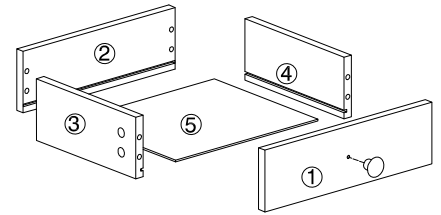
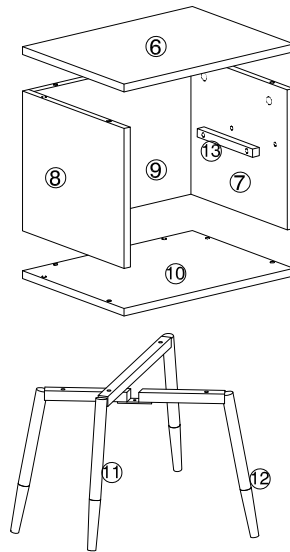
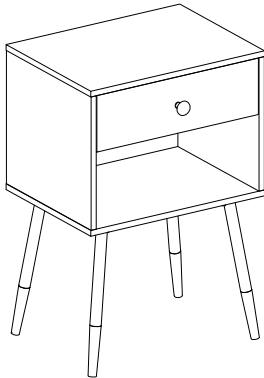

Componets

| | | |
|--|-----------|-------|
| | 372*117mm | ① X 1 |
| | 347*101mm | ② X 1 |
| | 272*102mm | ③ X 1 |
| | 272*102mm | ④ X 1 |
| | 354*267mm | ⑤ X 1 |
| | 400*300mm | ⑥ X 1 |
| | 300*276mm | ⑦ X 1 |
| | 300*276mm | ⑧ X 1 |
| | 375*276mm | ⑨ X 1 |
| | 400*300mm | ⑩ X 1 |
| | | ⑪ X 1 |
| | | ⑫ X 1 |
| | | ⑬ X 2 |

Screws&Tolls

| | | | |
|---|--|--------------|-----|
| A | | | X 8 |
| B | | φ6*30mm | X 4 |
| C | | φ5*40mm | X 4 |
| D | | M6*24mm | X 4 |
| E | | φ3.5*10mm | X 2 |
| F | | | X 1 |
| G | | φ4*35mm | X 4 |
| H | | | X 1 |
| I | | M4*16mm | X 1 |
| J | | M6*28mm | X 4 |
| K | | M6*12mm | X 1 |
| L | | 4mm 3mm | X 1 |

Check all the components & screws before assembly.

"A" Hardware installation example

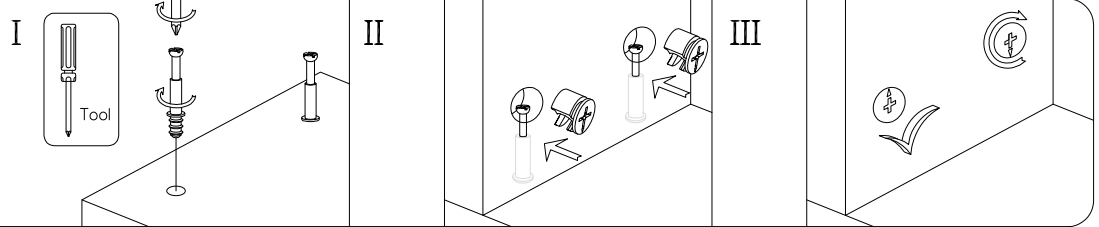

1 StepA: Drawer assembly

Gx4

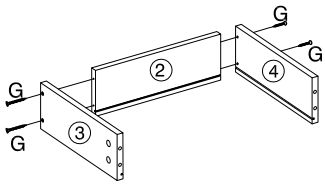

2

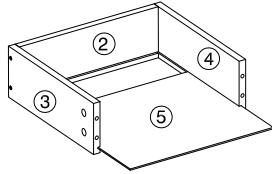

3

Ax4

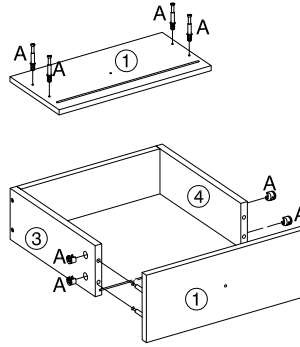

4

Fx1
Ix1

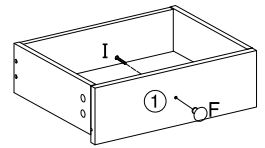

5

StepB: Body assembly

Tips:
When in stall H, please notice the direction of a and b

Ex2
Hx1

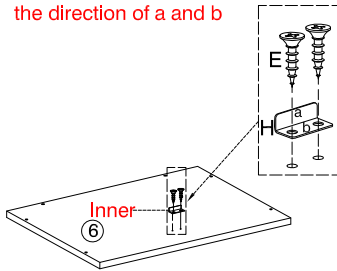

6

Ax4
Bx2

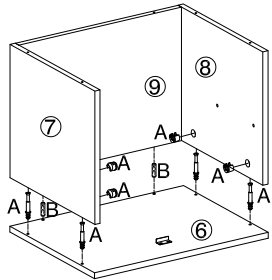

7

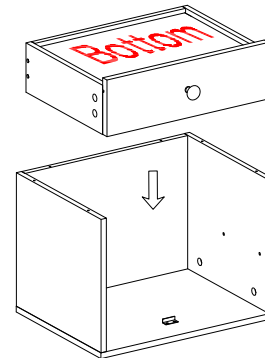

8

M6*24mm Dx4

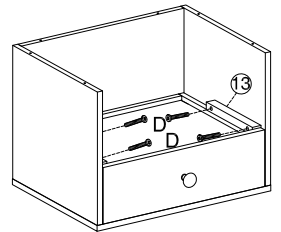

9

Cx4
Bx2

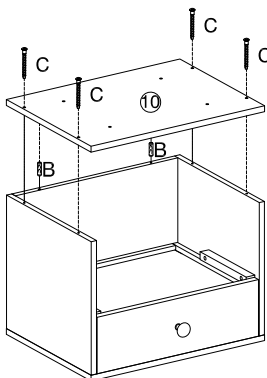

10

StepC: Legs assembly

M6*28mm Jx4
M6*12mm Kx1

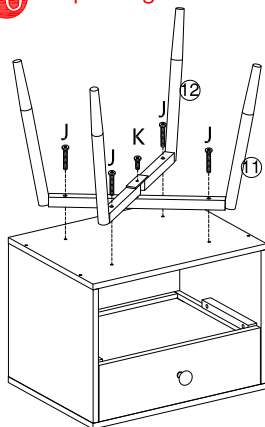

11

